

RADIO NEWS

AUGUST
1940
25c

Latest Radio Equipment now in service at Pan American Airlines Communication System.



Build Yourself a True Fidelity Receiver

A F AT-RESPONSE BATTERY OPERATED

Special Vacation Receiver ★ Simple to Build

Also the Latest News on **HAMS, SERVICEMEN and TELEVISION**

RM-10-151398-DN-120
AUGUST MACH
12019 BROWNING AVE
CLEVELAND OHIO

DAVEGA — AMATEUR DIVISION — 63 CORTLANDT STREET, NEW YORK, N. Y.

SMASHING LOW PRICE!

McMURDO SILVER 15-17

New r.f. amplifier equalizes gain at all wave lengths and provides in single stage, selectivity and gain heretofore available only in best two stage r.f. amplifiers. Four bands. Special Jensen-Silver 15" Giant electro-dynamic speaker. 30 to 8000 cycles. Heavy welded one piece chassis, 20" by 12 1/4".

Regular Price **\$205.00**
 Sale Price **\$109.50**
 You Save \$95.50

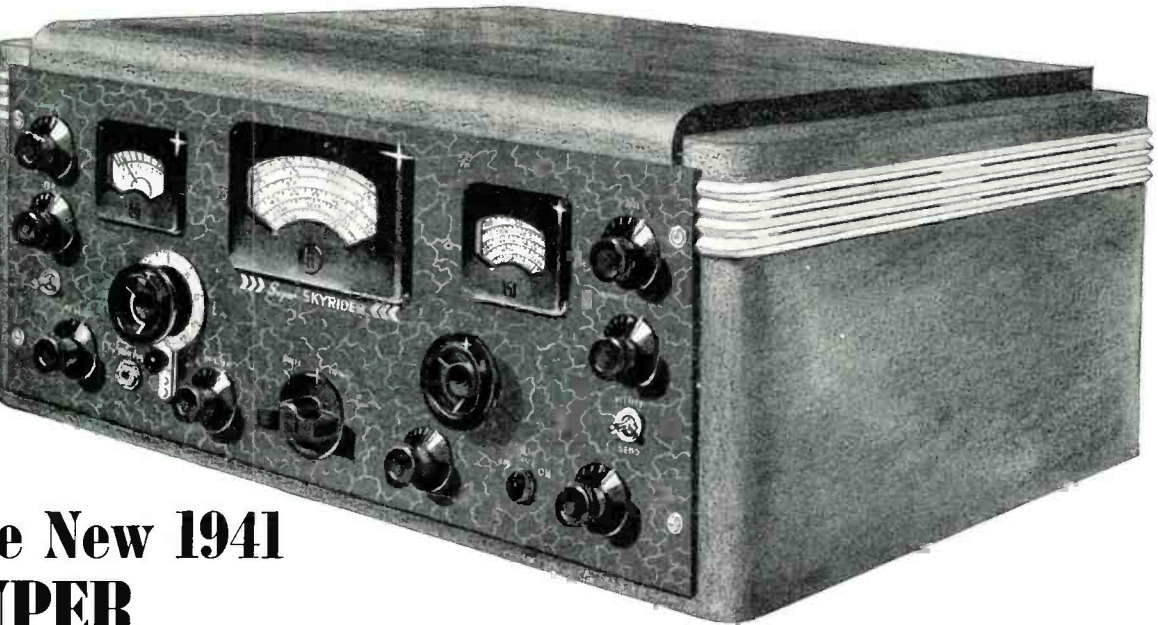

**The New 1941
 SUPER**

SKYRIDER

A few fundamentals of the new SUPER SKYRIDER are 6 bands covering 540kc to 43mc—2 stages of preselection—high fidelity, push-pull audio—band pass audio filter—a new and highly efficient crystal filter circuit—an additional and completely effective noise limiter—cadmium plated steel chassis—standard relay rack panel 1/8 inch thick—machine tool, gray wrinkle, well ventilated steel cabinet. Hallcrafters-Jensen *Bass Reflex* speakers available. Sells, complete with crystal and 14 tubes, less only speaker, for.....

\$159⁵⁰
 Net



Bass Reflex reproduction is now available through this Hallcrafters-Jensen *Bass Reflex* enclosure. Sells complete with special Jensen PM speaker for only..... **\$19⁵⁰**
 Net

All the famous Hallcrafters communications and short wave equipment is in stock. Sold anywhere on convenient terms.

DAVEGA

AMATEUR DIVISION, 63 CORTLANDT STREET, NEW YORK, N. Y.

"World's Largest Retail Radio Dealer"



BY THE EDITOR

THE international crises move so rapidly these days, that one has hardly time to catch one's breath over one crisis before we are into another one. Radio is keeping pace, however. The last two or three weeks brought radio to the fore. One of the most hair-raising things was the surrender of Belgium.

It so happened that we were home late that evening (or rather early in the morning), and the various broadcasters kept repeating that Premier Reynaud of France would broadcast a short statement to his people the next morning at 8:30 A.M. Paris time, 3:30 A.M. Chicago time. The announcers said that they did not know what the Premier had on his mind, but that the hour of the broadcast was so unusual, that it must be something important, and that they would stay on the air to give a liberal translation when the Premier spoke. We waited impatiently for 3:30 A.M.

Finally, the hour arrived. Reception was very, very poor from Paris. The Premier spoke briefly, and although we understand French, we could only catch a word here and there. The network then turned over the proceedings to their local commentators.

When these gentlemen came on the air, one could sense that they were at a loss for words. It seemed to them that Reynaud had made a sort of "pep talk," and they floundered around looking for words and explanations to tell the listeners why the Premier had broadcast, and why, particularly, the hour. Then they turned the broadcast over to Ed. Murrow of London, and the bombshell burst!

Murrow had heard the whole thing clearly in London, and it was he that informed a waiting world that Leopold of Belgium had capitulated! What a let-down! Now the whole reason for the talk became apparent, and the radio had once again redeemed itself as a means of immediate news. That was a breath-taking morning!

* * *

THERE can be no 5th Column here if the people will watch out for any evidence of one. In the most advantageous position are those who make it a hobby of listening on the various bands, both long and short wave.

Every day there are broadcasts in foreign languages on the upper ends
(Continued on page 46)

RADIO NEWS

Including Articles on POPULAR TELEVISION

The Magazine for the radio amateur
experimenter, serviceman & dealer
VOL. 24, NO. 2

Contents for August, 1940

FEATURES

- An Editorial on National Defense** Senator Claude Pepper **5**
A timely expression on the place the radioman can and will play in National Defense.
- Build Yourself a True-Fidelity Receiver** Jerome H. Kleker **6**
Combining the best in a homebuilt receiver with a well designed amplifier.
- As I See It!** John F. Rider **9**
What a National Emergency would mean to the serviceman.
- A Beginner's Hamstation for \$49.64, Part 2** A. B. Cavendish **10**
Concluding the series with the construction of a two-tube receiver.
- A Flat-Response Battery Remote Amplifier** Earl D. Hilburn **12**
Built to commercial specifications, this amplifier can be well-used by the P.A. specialist.
- The Vacation Special** William S. Hayes, W6MNU **15**
A nice, light-weight receiver for the outdoors.
- A Simple Signal Tracer** R. K. Wheeler **16**
Trouble-shooter's special; making an easy job of hunting radio "bugs."
- Ringing the Bell** Samuel Milbourne **21**
What about receiver repairs, and replacements? How do they affect the serviceman?
- Cut Loose from Chaos, Part 2** Walter E. Keever **24**
Keeping power and light line noises out of the radio program of your receiver.
- Building a Simple Superhet** Arthur Hertzberg **31**
A neatly designed and simple superhet that gives grand results.
- Notes on the Marine-Ham Receiver** Raymond P. Adams, W6RTL **36**
Revising the loop circuit of the marine receiver for better efficiency.
- A Reversible V. T. V. M.** D. H. Prewitt **33**
Some novel additions to an old and reliable circuit.

Cover Picture Courtesy of Pan American Airways

DEPARTMENTS

| | | | | | |
|-------------------------------------|----|-------------------------------------|----|------------------------------------|----|
| Book Review | 30 | QRD? | 30 | Serviceman's Experiences | 20 |
| What's New in Radio | 26 | Bench Notes | 19 | Serviceman's Cases | 40 |
| Radio Physics Course | 45 | Manufacturer's Literature | 42 | The Video Reporter | 25 |
| Hamchatteer | 32 | For Immediate Release | 29 | The Money Page | 39 |
| Servicemen's Legal Advice | 23 | Cuttings | 14 | Remotes | 37 |
| | | Utility Radio | 18 | | |

Copyright, 1940
ZIFF-DAVIS PUBLISHING COMPANY
Member of the Audit Bureau of Circulations

RADIO NEWS is published monthly by the Ziff-Davis Publishing Company at 608 S. Dearborn St., Chicago, Ill., William B. Ziff, Publisher; B. G. Davis, Editor; J. Fred Henry, Vice-president; Karl A. Kopetzky, W9OEA, Managing Editor; Oliver Read, W9ETI, Technical Editor; Herman R. Bollin, Art Director; John H. Reardon, Circulation Director; S. L. Cahn, Advertising Manager. New York Office, 381 Fourth Ave. Subscription \$1.50 per year; single copies, 25 cents; foreign postage \$1.00 per year additional except Canada. Entered as second class matter March 9, 1938, at the Post Office, Chicago, Illinois, under the Act of March 3, 1879. Contributors should retain a copy of contributions. All submitted material must contain return postage. Contributions will be handled with reasonable care, but this magazine assumes no responsibility for their safety. Accepted material is subject to whatever adaptations, and revisions, including "by-line" changes, necessary to meet requirements. Payment will be made at our current rates upon acceptance and, unless otherwise specified by contributor, all photographs and drawings will be considered as constituting a part of the manuscript in making payment.

THE SHACK PRESENTS

THE NEW 1941 SUPER

This new Hallicrafters receiver is the result obtained by asking more than 600 engineers and prominent amateurs what a really fine communications set should have.

Skyrider

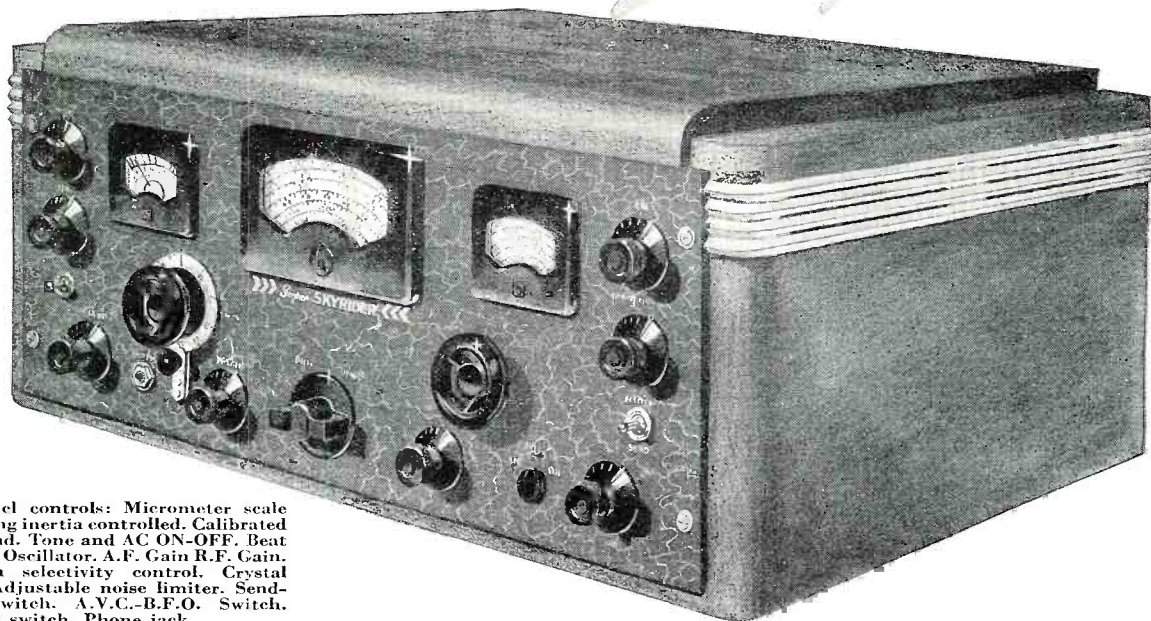

Front panel controls: Micrometer scale main tuning inertia controlled. Calibrated band spread. Tone and AC ON-OFF. Beat Frequency Oscillator. A.F. Gain R.F. Gain. 6 position selectivity control. Crystal phasing. Adjustable noise limiter. Send-Receive Switch. A.V.C.-B.F.O. Switch. Bass boost switch. Phone jack.

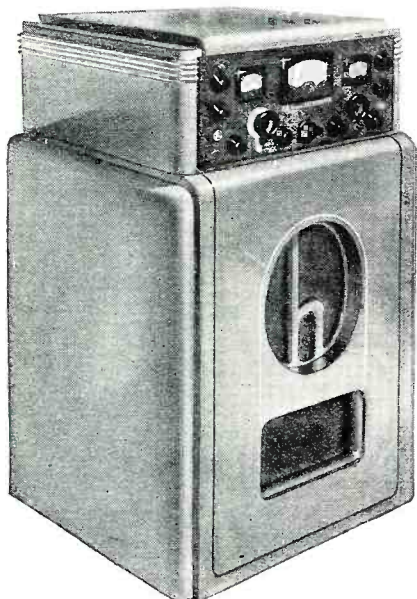

BASS REFLEX SPEAKERS

Two of the famous Hallicrafters-Jensen Bass Reflex speakers are available as extra equipment. One is 23½" high; the other (illustrated) is 30" high.

Designed to Government Specifications

A few fundamentals of the new SUPER SKYRIDER are 6 bands covering 540kc to 43mc—2 stages of preselection—high fidelity, push-pull audio—band pass audio filter—a new and highly efficient crystal filter circuit—an advanced and completely effective noise limiter—cadmium plated chassis—machine tool, gray wrinkle, well ventilated steel cabinet. Complete with crystal and 14 tubes, less only speaker.....

\$159.50
net.

RADIO SHACK is New England's oldest amateur distributor. We carry a complete stock of nationally advertised and short wave equipment. Mail the coupon for Catalog.



The RADIO SHACK
167 WASHINGTON ST., BOSTON, MASS., U.S.A.

AN EDITORIAL ON NATIONAL DEFENSE

Prepared specially for RADIO NEWS

by **CLAUDE PEPPER**

U. S. Senator from Florida

WE have undertaken to defend the Western Hemisphere—43,000 miles of coastline, from Iceland around the tip of South America and back to Alaska—against the crushing power of foreign aggressors. We cannot do this with broomsticks, nor wishful thoughts nor angry scowls across the seas.

We must do it with the most modern, the most effective weapons that can be devised. And we must have these weapons in greater quantities than any other power or combination of powers that may move against us.

This country comes to a time in history that we have never before experienced, standing virtually alone, without a single great power in the world as our friend. Cast the eye to the Orient, and we behold naught but defenseless China there, which may definitely and delicately call us blessed. But not the Japanese, not Italy, not Russia, not a dominant Germany; and where the ashes of England and France are, the heavy tread of German boots drowns out any appeal.

Too long, while the world was aflame, we took our day as it came, watching in apathy and in indifference while the edifice of civilization crumbled around our heads. That is what Great Britain did. The British arose in the morning, they spent a cultured gentlemen's day, they had tea in the afternoon and spent a delightful evening at dinner, with pleasing conversation animating the assembly.

Meanwhile, what happened beyond the Rhine? It was not indifference and apathy that prevailed there. There was no waste of time upon inconsequential things. Every minute was studded with 60 busy seconds and every hour was made the vital instrumentality of 60 minutes more of progress toward world conquest.

We know the terrible things which have happened. We know that they happened to democracies which had a great tradition, which had a great people, a courageous and virile people. Yet these great empires, which were thought invincible, these great bulwarks of democracy, these sentinels of civilization—where do they stand today?



Claude Pepper

This must not happen to us and it will not if we put our every energy into arming, as those who attack democracy have done. We must have the help and support of every citizen.

As the President has said, the problem of defending our national institutions and territorial integrity is no longer a problem for men equipped simply with an indomitable determination. Modern defense requires that this determination be supported by highly equipped machinery.

The requirements of industry and the expanded armed forces for persons with technical experience is obviously going to be great. We do not have such trained persons, the President has pointed out, in the number that will be required for the

tasks that lie ahead of us.

You in radio know the importance of that specialized service. For radio is one of the modern miracles which has remade the face of war. Armies go into battle now with their activities directed by orders radioed. Each company of infantry carries its own portable radio equipment—the "talkie-walkies"—as it moves into combat. Artillery fire is directed by radio by observers in planes or balloons. Tanks, airplanes and battleships are directed by radio. The armed forces are assigned their own air channels, but in times of emergency must utilize all channels for mass communication.

The job of producing the radio equipment for our defense forces must and will be done quickly by the great radio industry. Those who know how to handle transmitting and receiving equipment must be ready to give their help. The amateurs, experimenters, engineers and operators; the professional engineers, operators, production and professional men all will be needed to fill the need for technically trained persons.

This country is fortunate, because it has more and better radio men than any other nation. They will rally now to the nation's defense as Americans always have.

For on this one cause—the preservation of the decent philosophy of a decent world and the sacred integrity of our own country—we stand united, one indivisible people.

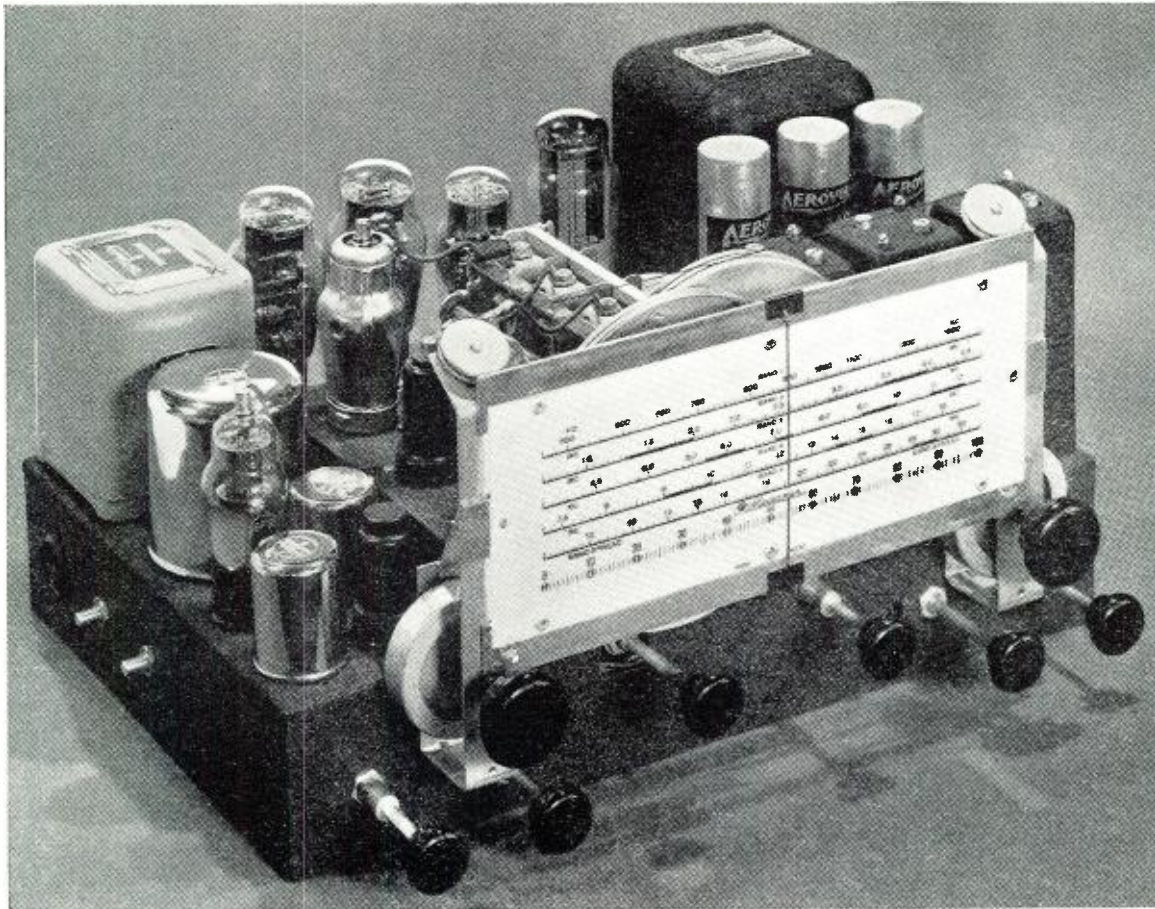

This is a beautiful receiver, as a test will show; has excellent quality.

BUILD YOURSELF A True-Fidelity Receiver

by **JEROME H. KLEKER**

Chief Sales Engineer, Thordarson Electric Mfg. Co.
Chicago, Illinois

By combining a very fine superhet circuit with a superb audio system, Mr. Kleker has turned out one of those receivers every radioman wants.

THE design of this receiver is the result of a successful attempt to incorporate in a single unit, every desirable feature for radio reception. The ability faithfully to reproduce radio transmissions without amplitude or harmonic distortion was considered to be most important. Equally essential was the coverage of both short waves and broadcast with good sensitivity. These characteristics have been achieved beyond expectations. European broadcasts from Paris, Berlin and London are of special interest at the present time and

have been received almost equal to local reception for the past two months. Overall fidelity is so superior to most receivers that discriminating listeners who have heard it requested constructional data even before it was available.

In a receiver of this type the radio frequency circuits, detector and audio frequency amplifier are of great importance. The r.f. circuit must be capable of extreme selectivity and sensitivity for reception of weak, almost inaudible signals. For high-fidelity reception, these same r.f. circuits must

be broadened to pass frequencies above 2,000 c.p.s. This has been accomplished with iron core expanding i.f. transformers, with three degrees of selectivity (Selective-Normal-High-Fidelity).

The second detector is often overlooked as a source of distortion. When the audio amplifier and speaker are capable of passing frequencies from 5,000 c.p.s. to 10,000 c.p.s., detector distortion becomes serious. An infinite impedance detector was found necessary and no noticeable distortion is present. This detector is not bur-

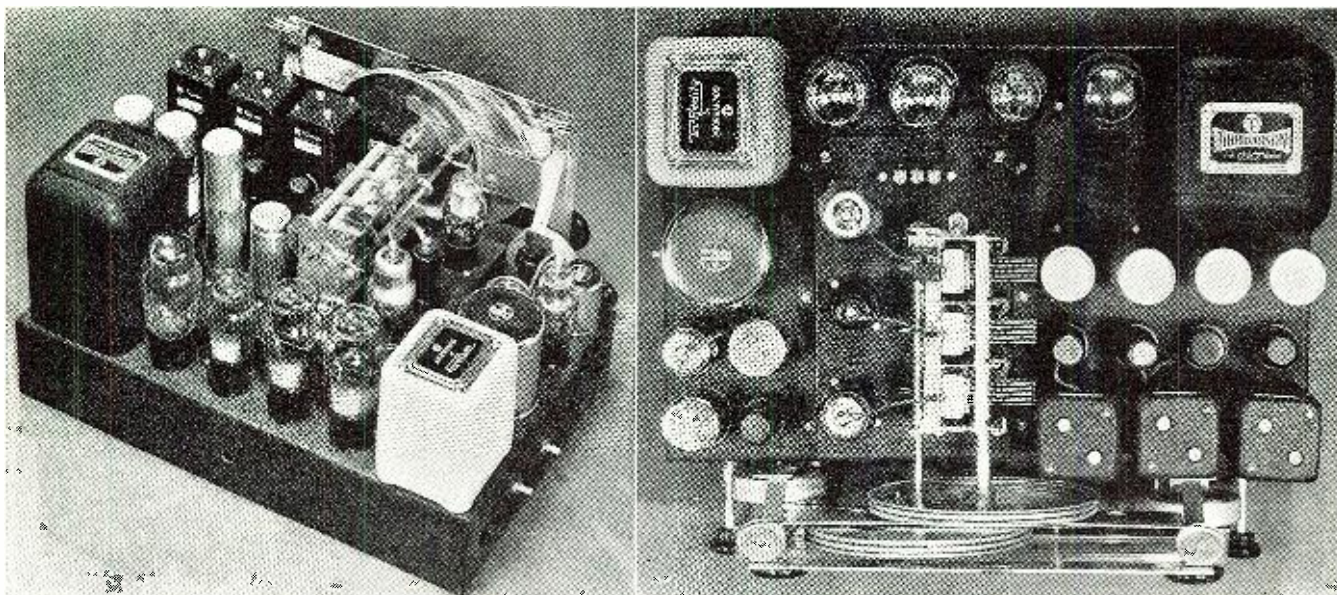

While seemingly very compact, the component parts are carefully laid out for the maximum performance.

This illustration can be used as a layout template, because it shows where each part goes on top of the chassis.

dened with the function of automatic volume control. A separate 6H6 diode rectifier tube provides bias for A.V.C. and is not connected to the detector circuit proper. So effective is this circuit that there has been no objectionable fading even on weak signals. A sensitivity control provides the dual function of operating without A.V.C. and between-station noise silencer. When the control is in a "reduced sensitivity" position, noise between broadcast stations is eliminated inasmuch as the overall gain is reduced. Five r.f. bands provide reception from 9 to 550 meters.

The audio amplifier consists of three stages, the first of which is essentially a tone control stage. Tone compensation is effected by means of degeneration (inverse feedback). This method of control has been found superior because of the entire absence of distortion. Resonance tone compensation circuits often cause distortion and hang-over effects especially in low frequency booster circuits. The degenerative tone control tends to cancel any distortion that might develop. Treble and bass frequencies can be increased 15 *db* or decreased 25 *db* entirely independent of each other. This flexibility is desirable for high fidelity reproduction as well as speech clarification with foreign and amateur reception.

The second amplifier stage employs a type 6F8G tube operating in a push-pull circuit. A push-pull stage is desirable at this point because of the high grid-to-grid voltage required properly to excite an output stage. A single tube develops second harmonic distortion at high signal levels whereas this distortion is cancelled in a push-pull stage. Two 2A3 tubes are used in the output stage because of their excellent characteristics so well suited for operation into a loud speaker load. At 10 watts output, to-

tal distortion does not exceed 2% and 15 watts output is obtainable with less than 5%. The recommended tone control choke and audio transformers incorporate hum-bucking coil construction and high permeability shields. These features are essential when the audio components and power supply are constructed on a single chassis. Transformers of regular shell type construction; and unshielded ones should not be used if hum is to be kept below audibility. Low hum is especially preferable in quiet installations such as the home.

One might gather from the above that the construction of a receiver of this caliber is complicated. On the contrary, the components which have been chosen simplify assembly considerably. The chassis layout as shown in the illustrations should be followed to facilitate wiring and assure the proper placement of parts. Wiring is not complicated since the entire r.f. assembly (consisting of the first r.f. stage, first detector oscillator, tuning condenser, band-spread condenser and band-change switch) is available as a single unit already wired and tested. A cutout in the chassis receives this unit with shafts protruding in front for assembly of the dial. The combination tuning and band-spread dial is accurately calibrated assuring easy logging of both broadcast and short-wave stations. A glance at the parts list will reveal the relatively small number of components required.

Assembly of the Receiver

Assembly is started by installing the sockets and power transformer on the receiver chassis. Proceed to wire the tube filaments, taking care not to cross the large opening in chassis which receives the tuning unit. Install the audio transformers, filter chokes and large filter condensers and complete all of the wiring to these components. The output transformer has secondary

impedances of 1.25, 3.75, 5, 7.5, 10 and 15 ohms. Instructions are supplied for proper terminal connections. Wire the loud speaker socket to the transformer terminals corresponding to the impedance of the loud speaker that will be used. Assemble the i.f. transformers, controls and other small accessories. After these have been wired and the small self-supporting resistors and condensers connected, the tuning unit can be fastened in the chassis and the wiring completed. The tuning unit and dial should not be installed until all of the other parts have been installed and wired. This greatly eliminates the possibility of damaging the coils or dial during assembly and wiring. The long control shafts should be cut to the approximate length or slightly longer than the dial shafts. The tone controls and i.f. expander switch shafts require extension to make their length equal the dial shafts. Install shaft extensions after cutting them to the proper length.

Separate bias controls are provided to balance the plate current of the 2A3 output tubes. Once the bias controls have been adjusted for proper plate current, they need not be touched unless the tubes become aged or are replaced. The preferred method of measuring this current is with a receiver analyzer such as used by service men. If this is not available, a 0 to 100 ma., d.c. meter can be installed in the plate lead of each 2A3 tube. A single meter will have to be changed from one plate circuit to the other during this adjustment. For proper operation, adjust each 2A3 tube to 40 ma. Distortion and hum will be minimum when the output tubes are properly balanced. It is recommended that all voltages be checked immediately after the 2A3's are adjusted.

The tuning unit and i.f. transformers are adjusted at the factory and selectivity and sensitivity will be good

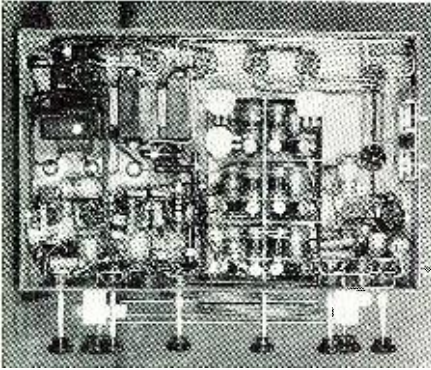

Underchassis view of the receiver. Note coil position and wiring.

without further attention. If it is desirable to adjust the condensers, a good signal generator is recommended. Instructions are furnished with the tuning unit for adjustment and proper alignment of the tuning dial.

The enjoyment of the *Tru-Fidelity Receiver* will be greater if it is used in conjunction with a high-fidelity loud

speaker. Ordinary speakers are inefficient in the high frequency response and also on the low frequency response unless a good enclosure or baffle is used. The new single unit high fidelity speakers supplied with enclosure are satisfactory for most applications.

However, if the utmost is desired, the new dual speaker systems are recommended. These consist of a low frequency cone-type speaker and a "tweeter" or high-frequency speaker with filter network to divide the audio frequencies. The tone control is especially effective when the loud speaker reproduces the complete audio spectrum.

The use of a doublet antenna will insure better short wave reception. The tuning unit is wired for this type antenna which simplifies connections and provides good efficiency. Several kits are available with all wires cut to correct length. Tests made in a metropolitan location showed so great a decrease in auto interference and man-made static that good reception

is possible at almost any time of day.

In addition to listening tests, complete laboratory measurements have been made on the receiver. With the tone controls in center or normal position, and the selectivity switch in the "selective" position, the high-frequency response began to fall off at 500 c.p.s. and was down 30 db at 4,000 c.p.s. With the selectivity switch set at "normal" the response began to fall off at 1,500 c.p.s. and was down 10 db at 4,000 c.p.s. When set at "high-fidelity" the response began to fall off at 3,000 c.p.s. being down only 4 db at 4,000 c.p.s. By turning the treble tone control to maximum increase position it was possible to have an actual increase of 1 db at 5,000 c.p.s. with excellent response out to 10,000 c.p.s.

The excellent audio frequency characteristics of the receiver can be used to advantage with phono records. A jack is provided on the side of the chassis for use with a high impedance magnetic or crystal pick-up. When the phono pick-up plug is inserted the detector is disconnected.

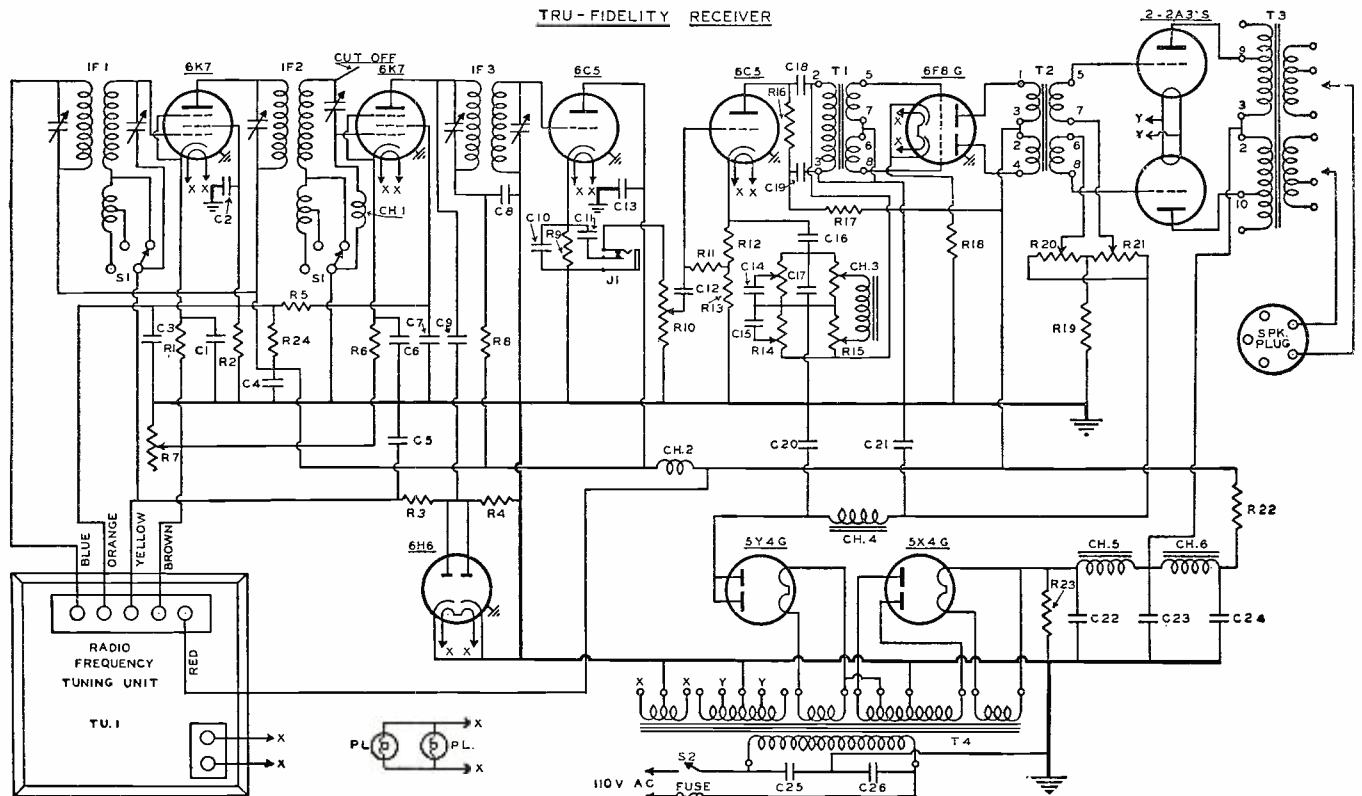

Circuit diagram of the True-Fidelity Receiver.

Transformers and Chokes are Thordarson
 T₁—T-1A60 Bantam Interstage Transformer
 T₂—T-2A41 Major Interstage Transformer
 T₃—T-3S21 Major Output Transformer
 T₄—T-15R05 CHT Power Transformer
 CH₁—T-1C69 Tone Control Choke
 CH₂—T-18C92 Bias Filter Choke
 CH₃—T-13C30 First Filter Choke
 CH₄—T-18C92 Second Filter Choke
 TU₁—Meissner, 13-7604 Tuning Unit
 IF₁—Meissner, 17-7416 Iron Core I.F.
 IF₂—Meissner, 17-7416 Iron Core I.F.
 IF₃—Meissner, 16-6644 Air Core I.F.
 CH₅—Meissner, 19-7908 Choke
 CH₆—Meissner, 19-1996 Choke
 C₁—.05 mfd. Aerovox No. 284
 C₂—.05 mfd. Aerovox No. 284
 C₃—8. mfd. Aerovox No. 3—GL-250 (8-8-8 mfd.)
 C₄—.1 mfd. Aerovox No. 484
 C₅—.1 mfd. Aerovox No. 284
 C₆—.1 mfd. Aerovox No. 284

C₇—.05 mfd. Aerovox No. 284
 C₈—.05 mfd. Aerovox No. 1469 (Mica)
 C₉—.00025 mfd. Aerovox No. 484
 C₁₀—.00025 mfd. Aerovox No. 1469 (Mica)
 C₁₁—.1 mfd. Aerovox No. 284
 C₁₂—.1 mfd. Aerovox No. PRS-450
 C₁₃—8. mfd. Aerovox No. 284
 C₁₄—.03 mfd. Aerovox No. 284
 C₁₅—.03 mfd. Aerovox No. 284
 C₁₆—.1 mfd. Aerovox No. 284
 C₁₇—.0015 mfd. Aerovox No. 1467 (Mica)
 C₁₈—.5 mfd. Aerovox No. 484
 C₁₉—8. mfd. Aerovox No. PRS-450
 C₂₀—Part of C₃
 C₂₁—Part of C₃
 C₂₂—16. mfd. Aerovox No. G-450
 C₂₃—16. mfd. Aerovox No. G-450
 C₂₄—16. mfd. Aerovox No. G-450
 C₂₅—.01 mfd. Aerovox No. 484
 C₂₆—.01 mfd. Aerovox No. 484
 R₁—800 ohm, Centralab No. 714
 R₂—10,000 ohm, Ohmite 10 W.

R₃—400,000 ohm, Centralab 714
 R₄—250,000 ohm, Centralab 714
 R₅—5,000 ohm, Centralab No. 714
 R₆—800 ohm, Centralab No. 514
 R₇—25,000 ohm, Centralab No. 514
 R₈—2,000 ohm, Centralab No. 514
 R₉—150,000 ohm, Centralab No. 514
 R₁₀—250,000 ohm, Centralab No. 72-121
 R₁₁—500,000 ohm, Centralab No. 514
 R₁₂—1,000 ohm, Centralab No. 514
 R₁₃—20,000 ohm, Centralab No. 514
 R₁₄—Thordarson R-1068 Dual Tone Control
 R₁₅—Thordarson R-1068 Dual Tone Control
 R₁₆—20,000 ohm, Centralab No. 514
 R₁₇—10,000 ohm, Centralab No. 514
 R₁₈—500 ohm, Centralab No. 514
 R₁₉—3,500 ohm, Yaxley No. M3MP
 R₂₀—3,000 ohm, Yaxley No. M3MP
 R₂₁—3,000 ohm, Ohmite 10 Watt
 R₂₂—1,500 ohm, Ohmite 10 Watt
 R₂₃—25,000 ohm, Ohmite 25 Watt
 R₂₄—12,000 ohm, 10 W.

A S I SEE IT

by **JOHN F. RIDER**

Dean of the Servicemen

If war comes to these United States, just what will it mean to the radio serviceman?



John F. Rider

Henny-Penny!
 ▽ **HERE** are many times in the past when, putting aside the vices and vicissitudes of business, I used to read my little daughter to sleep. One of her favorite stories was the one about *Henny-Penny*. I am sure there are those of you who remember the tale which concerns itself about a silly hen who upon being struck on the head with a grain of corn insisted that the world had come to an end. She ran through the barn-yard, panic-struck, and got all the other animals into a lather. It was only the cool head and calm thinking of the little girl, the heroine of the piece, that restored order where there had been chaos, and who assured the animals that they were all upset about nothing more than a grain of corn!

Well, perhaps there is more than a "a grain of corn" to be concerned about at this time, when internal crisis piles upon international crisis. But, as I see it, there certainly is no reason at all for emulating that story-book character, *Henny-Penny*.

Let us analyze the situation calmly . . . for without calmness there can be no reason. And *reason* is what we have the most need of right now. Have you been listening to the President recently? He said that we would need over a 1,000,000 men, trained technicians, behind the lines for work to aid the *National Defense*. Just what does that mean? It certainly applies to the radio serviceman probably more than to any one particular group.

Radio communication among the citizenry is at once the most important mission of any nation at war. To keep the public informed, to keep public opinion riding along certain trends, to disseminate propaganda . . . all these things, as well as entertainment, are the functions of radio in times of emergency.

Thus it can be said that the immediate results of any Emergency will not be a decrease in the serviceman's business . . . not by any means . . . it will increase! And how! Back to life will come radio receivers which have long been gathering dust on the shelves, whose tubes are not only outmoded but whose innards are cranky and creaking with time. These will have to be put into apple-pie order, and quickly!

And who is going to do this gargantuan job? The serviceman! . . . For not all of them, nor even a great majority of them will find themselves in the

Militia. Many are too old, many have large families, many are not physically fit. To those who stay home will come a tremendous increase in business. . . . So these servicemen should be prepared for this. Sets will have to be quickly repaired, and a lasting job done. The men who will be best equipped with proper training and instruments to do a fast job will reap the profits. Time will be more precious than ever, and such a thing as keeping a chassis in your shop for any great length of time will lose you more customers than anything else.

As in all Emergencies, prices will rise. Not only of parts but also of instruments. This will be so because the government will "call" for the output from many a factory. . . . This will also result in many of our servicemen leaving the trade as such and going into the manufacturer's services. Those dabblers on the fringe, whose radio training is rudimentary, will go into business as servicemen to replace those, more experienced, who have left that field for the manufacturer or the Military. . . . Definitely, there will be a shortage of servicemen, and there will be more business than we will be able to handle.

The number of receivers will increase . . . and we don't mean the old ones in this case. New sets with fewer parts and multi-function tubes and circuits. More complication in smaller space. These sets will sell at the same price or slightly higher than their prototypes of today. The servicing of these sets will have to be done by the serviceman, since manufacturer's servicing will be somewhat curtailed by the orders for new sets and they will be kept busy filling the orders. This means more business . . . for the serviceman.

One thing remains outstanding, like a lighthouse on a moon-less night. Communications are a vital force during any Emergency. Since the serviceman is more nearly familiar with, and has been working on communications as a trade for, lo, these many years, he will

be in demand, whether at home, or in the Military.

So to get back to *Henny-Penny*. Don't feel that because the news you read is not encouraging, because the talks you hear are pro-war, the stock-market goes down, or that the *Secretary of State* sells the *Allies* airplanes,—that the servicing business is on the slides. Nothing could be more wrong. Nothing could be more ridiculous. Radio servicing is just coming to the fore. It will develop into a big business under the impetus of a *National Emergency*. Will you be prepared for the rise? Will your shop have the proper equipment? Will you be ready to do servicing jobs, quickly, and efficiently? Those are the questions that should concern you!

There has been some talk that expansion at this time, in a service shop, is unwise, and that the War will knock the "expanders" into a cocked hat. Not
 (Continued on page 46)



Nothing beats a nice quiet afternoon with just your radio and good music!

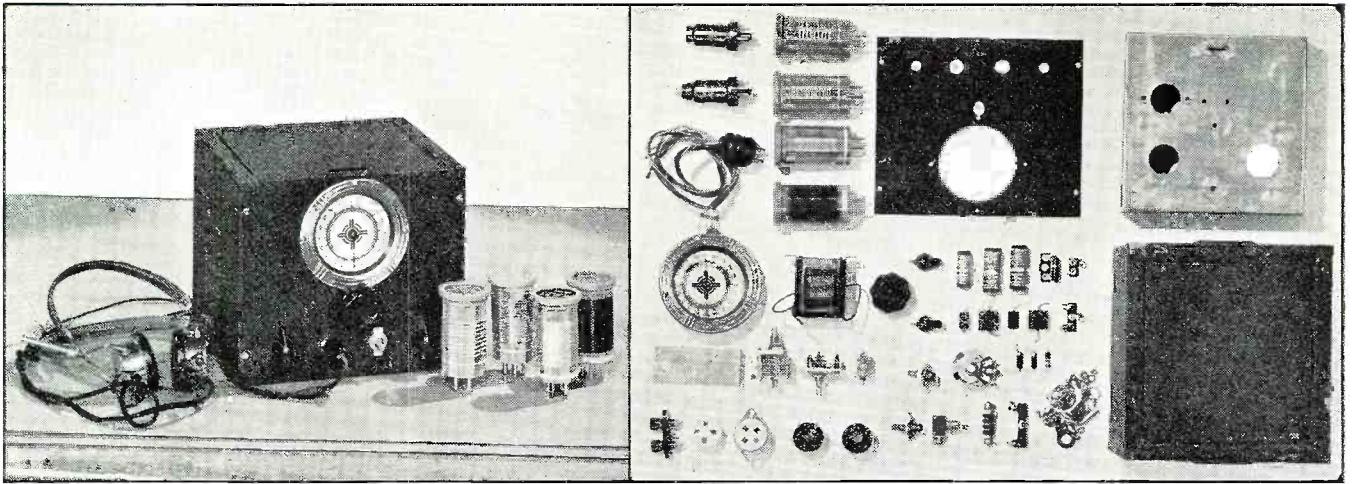

This is the complete two-tube receiver which is the counterpart to the transmitter described last month. The receiver operates with four Hammarlund short-wave coils, factory built.

This is the complete layout of each and every part which is used in the construction and operation of the receiver, including the tubes. While substitutions may be permitted, the performance might suffer accordingly.

BEGINNER'S COMPLETE STATION

FOR \$49.64 BY A. B. CAVENDISH

Savannah, Georgia

Completing the hamstation which we started last month. This little receiver goes places!

PART 2: THE RECEIVER

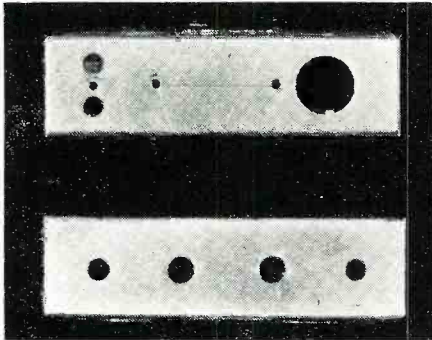

Drilling of the holes in the chassis ends is the first thing to do. The upper illustration is the rear of the chassis, and the socket hole is for the connecting plug to the transmitter power supply which is used.

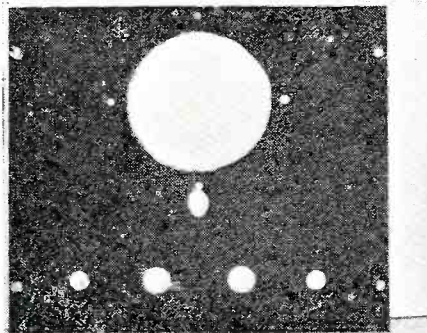

The front panel is next drilled out to conform to this illustration. The large center hole is for the "airplane" type tuning dial which acts at once as a good vernier. The size depends on the dial.

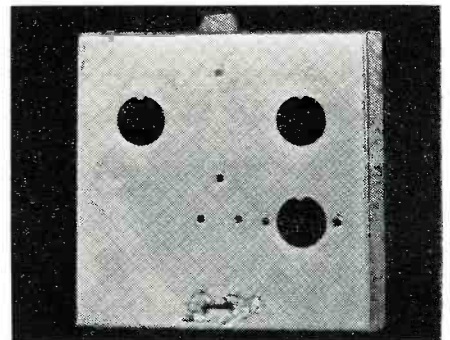

The chassis top is next prepared. The two holes to the front are for the sockets of the tubes, while the third hole is for the coil which will be mounted above the chassis for ease in making connections.

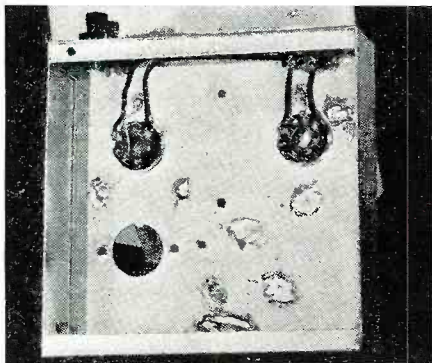

After the holes have been drilled, mount the sockets (octals, bakelite) and wire in the filament circuit starting from the connecting socket in the chassis rear and running over to each socket separately.

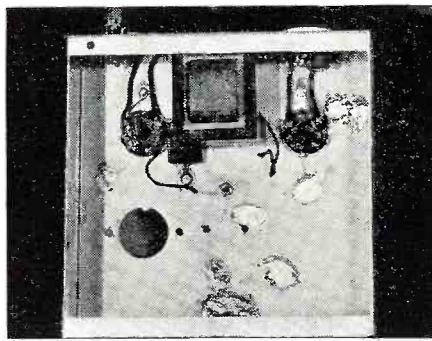

Once the filament connections have been made, the audio choke is next mounted up against the rear of the chassis. Before tightening down the choke, the mica condenser C9 should be soldered to "ground."

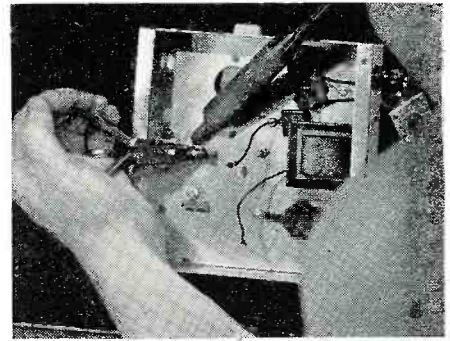

Wherever it is necessary to use terminal lug strips, these are soldered to the chassis, saving the drilling of a hole; and this illustration shows how the soldering is done. Use a pair of pliers—irons are hot!

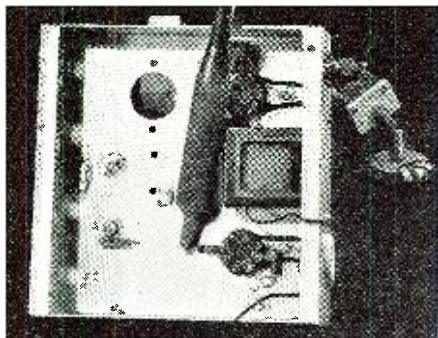

Wherever a part is "grounded" in the diagram, this is done by soldering that part directly to the chassis which acts as a ground. Do not use anything but rosin-core solder, the other kinds cause trouble.

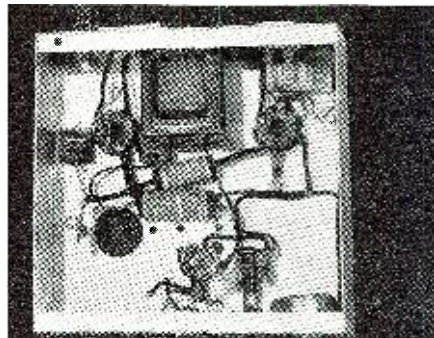

After all the circuit has been wired in, excepting the coil connections, a "riser" is built with 1" washers of the condenser type. These washers are slipped over 2" bolts and hold the socket off the chassis.

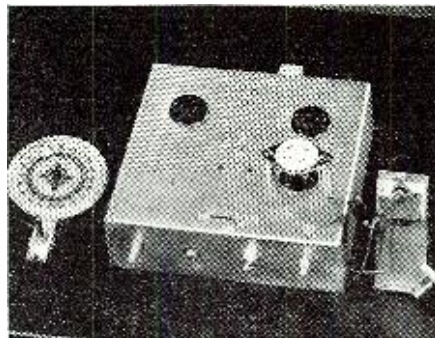

With the socket for coil mounted, a bracket for the vernier condenser is made of electraloy. The dimensions are not given because they will vary with the type of dial used. The condenser must match this.

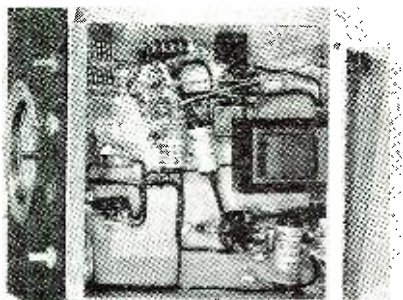

With the wiring completed, the panel is next mounted. All the parts that project through the front of the chassis are mounted directly to the panel, being used to hold the panel to the receiver chassis.

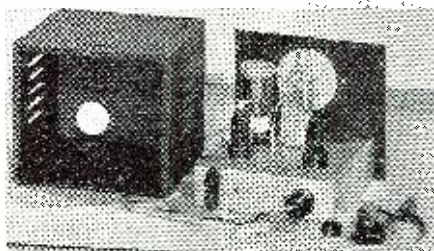

A 2" hole is drilled in the back of the cabinet for the power supply connections. It may be made with a socket punch, and the hole smoothed with a round file, or it may be made the same as the dial-hole.

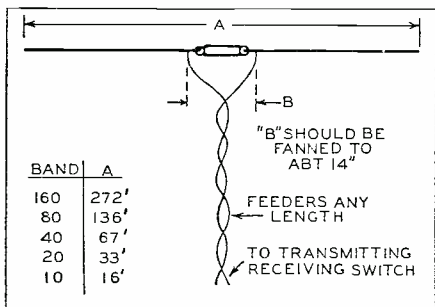

This is the same antenna recommended for the transmitter. Sizes are given for the various bands. A general receiving band antenna may be made of a single wire 50' long. This will not be noise-silencing.

LAST month we described, pictorially, the construction of a small transmitter. This month, we complete the station with a description of a two-tube sensitive receiver.

The power supply included in the transmitter is used also for the receiver thereby saving money and making it virtually impossible to transmit and receive at the same time. A double pole, double throw toggle switch, included in the transmitter, serves to switch the power from one to the other.

The construction of this little receiver is much more simple than that of the transmitter. At the top of page 10 can be seen all of the parts layed out. The drilling of the large hole for the airplane dial is accomplished by marking the panel with a crayon and then drilling a great number of 1/8" holes around the circle previously marked out. Then, with a cold chisel, or with the drill itself, these little holes are "connected up" and the cut-out is completed. It is then filed smooth and of the correct size to accept the dial. The tube socket cutouts are punched in the chassis by means of the very same socket punch used in the transmitter. Since the set is so small in actual physical size, no ground bus bar is used and the "grounds" are all by means of soldering direct to the chassis itself.

In actual use, the receiver will be found to be extremely sensitive and tuning over the frequency range must

be done slowly if full benefit from this receiver is to be had.

Not pictured in either article is the antenna and ground system, concerning which the beginner may consult any handbook. Naturally, the antenna

and ground system are the means by which the signal is both received and transmitted; and unfortunately, too many beginners give too little attention to this important detail.

-30-

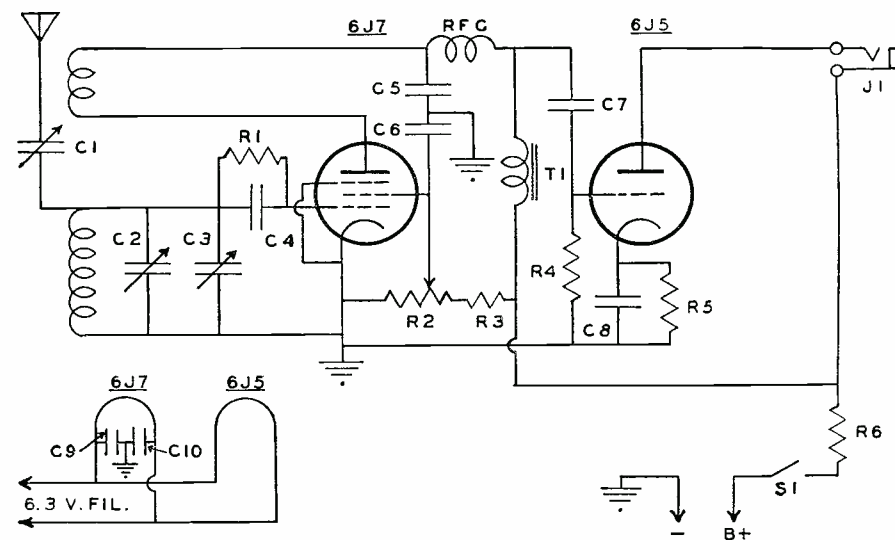

- R₁—3 megohms, 1/2 w. IRC
- R₂—10,000 ohm pot. Yaxley Y10MP
- R₃—10,000 ohms, 1 w. IRC
- R₄—500,000 ohms, 1/2 w. IRC
- R₅—2,000 ohms, 1/2 w. IRC
- R₆—50,000 ohms, 1 w. IRC
- C₁—3-30 mmf. Mica padder. Hammarlund Mex. 30
- C₂—100 mmf. Cardwell ZU 100AS
- C₃—35 mmf. Cardwell ZR35AS
- C₄, C₅—100 mmf. mica. Sprague
- C₆, C₈—1 mf. 600 v. paper. Sprague

- C₇—.01 mf. 600 v. paper. Sprague
- C₉, C₁₀—.005 mf. 500 v. mica. Sprague
- T₁—700 hy. audio choke. Thordarson T29C27
- RFC—2.5 mhy. r.f. choke. Bud.
- J₁—Open circuit jack. Mallory
- S₁—SPST toggle switch. Arrow
- Chassis—7"x7"x2". Bud No. 201
- Cabinet—7"x8"x7 1/2". Bud C973
- Coils—Hammarlund SWC41-42-43-44
- Sockets—Amphenol
- Dial—Eddie or Crowe aircraft dial
- Tubes—1—RCA 6J7, 1—RCA 6J5



The complete battery-operated remote amplifier as used by radio station WIBU.

A FLAT-RESPONSE BATTERY REMOTE AMPLIFIER

by Earl D. Hilburn

Madison, Wisconsin

There will be times when the serviceman might want to have an amplifier which is hum-free and has a very flat response. The unit outlined here meets all these requirements neatly.

WITH the coming of spring and the increased activity in outdoor sports, the remote crews of America's broadcasting stations will be "setting up" at ballparks, tracks, tennis courts, golf links and wherever else the sports-loving public gather. The remote crews' job is that of bringing the favorite sporting events to the thousands of fans who sit at home with their ears cocked toward their receivers. And year after year as these broadcasters gather, there is a gradual change in their equipment. The trend is always toward higher quality standards, higher efficiency, compactness and improved appearance.

In keeping with the above trends, this remote amplifier was built. It was designed to provide an efficient, self-contained, amplifier that would be pleasing in appearance and as com-

pact and portable as possible, keeping the building and operating costs to a reasonable figure.

The unit was built to meet the following limiting specifications:

1. Electrically the unit must equal or better the quality obtainable from the rest of the speech equipment employed at the station.
2. It must have four channel input. Three of the channels for 250 ohm impedance microphones (ribbon or dynamic), the fourth must be designed for crystal or other high impedance input.
3. It must have sufficient gain to

handle any available microphone.

4. It must have self-contained battery supply and if possible contain a spare set of both tubes and batteries.

A thumbnail description of the finished article would probably include these features: Overall dimensions (cover in place); 9" high, 16½" wide, and 8" deep. Weight (one set of tubes and batteries included); 20 pounds. Overall gain; 100 db. Undistorted power output; 100 milliwatts. Frequency characteristics; plus or minus one db from 28 to 15,000 c.p.s. (reference level of 1000 cycles).

Electrical Considerations

The first electrical consideration, is of course, the tube line up. Investigation of the tubes available at the time this unit was built seemed to leave the logical choice at a pair of 1N5G's and one 1A5G. Such a line up provides the

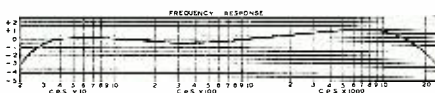

The response curve.

required gain and power output and at the same time keeps the battery drain to a minimum.

Using the 1A5G, the problem arose as to what to do for the bias supply. Examination of the batteries available showed that difficulty would be had in obtaining a "C" battery and a "B" battery that would wear uniformly with use, and so decrease the bias proportionately as the plate voltage lowered. Two alternatives appeared. First, a loading resistor could be shunted across the "C" supply while the amplifier was in operation, to provide an experimental adjustment for varying the load on the "C" battery. Or, self bias might be employed. The latter course was decided upon as being the best.

Using self-bias, with the filament type tube, it would have been necessary to make the grid return leads of the 1N5G's directly to the filament of the tubes rather than to ground to avoid biasing of these tubes as well as the 1A5G. Rather than to do this, and take the chance of obtaining unwanted coupling through the common supply, two separate filament supplies were used.

The next problem to be tackled was that of the metering. It was desired to be able to check the operating voltages under load from the front panel. To use the "Db" meter to do this, the copper oxide rectifier and the multiplier and calibrating resistance units were removed from the case. The indicated switching circuit was employed, to use the galvanometer movement of the meter to check the battery voltages (in combination with suitable multiplier resistors, of course). The rectifier and the meter resistors with the new multipliers were housed in the small shield can shown in figure two, just to the rear of the meter.

The switch on the front panel provides selection for measuring the voltages. To determine the condition of the batteries, the power switch is turned to the "on" position and the meter switch is turned to the "A" and then to the "B" positions. The multiplier values were so chosen to give a range such that when the indicated voltage dropped below "0" on the Db meter, the batteries are to be discarded. The calibration curves furnished here, were made from comparison of this meter with the standards in the electrical laboratory of the physics department of the University of Wisconsin.

Though only one of the two "A" batteries used is checked by the meter, this is sufficient as the drain on the two batteries is uniform.

From the stock batteries available, the combination used was chosen with the idea of having the battery life uniform for all batteries used. However, according to the engineering staff of the battery company, the "A" batteries will give several hours more service than the "B" batteries. Most likely, because of the low price of the batteries, the whole set will be re-

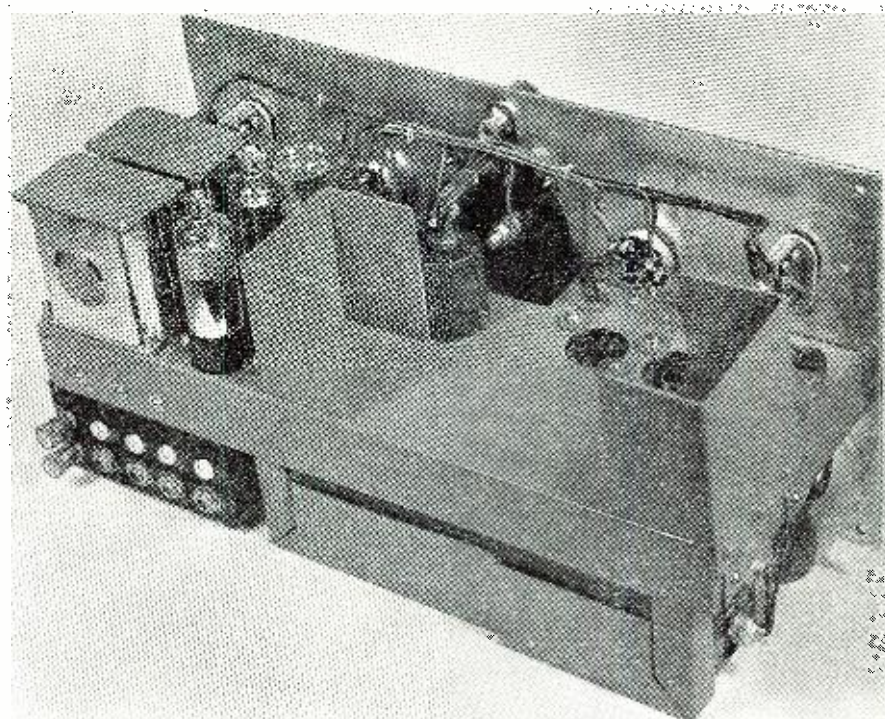

An example of professional wiring and construction. Note how rigidly the wires are held in place. The two "parenteses" are where the batteries are carried.

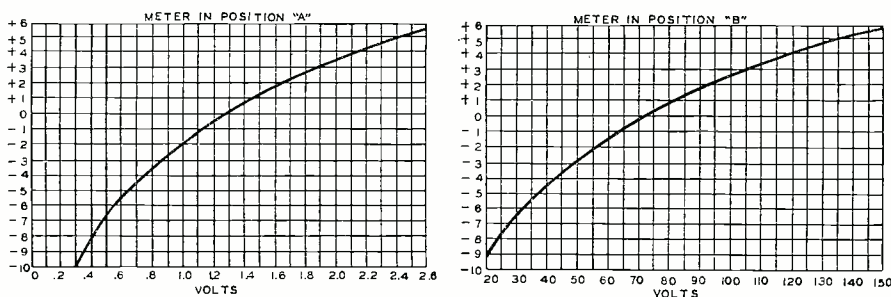

Conversion charts for converting DB meter readings to volts.

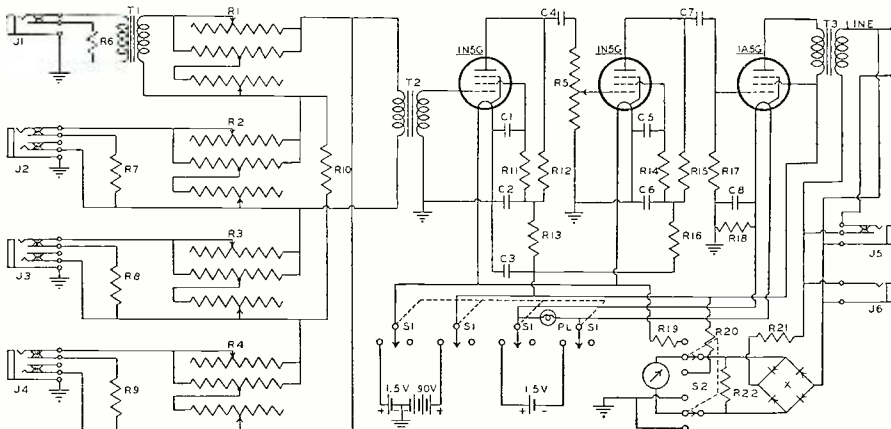

R_1, R_2, R_3, R_4 —250 ohm "T" Pad. IRC
 R_5 —.25 megohm pot. IRC
 R_6 —50,000 ohm, 1/2 watt. IRC
 R_7, R_8, R_9, R_{10} —250 ohm, 1/2 watt. IRC
 R_{11} —3 megohm, 1/2 watt. IRC
 R_{12} —5 megohm, 1/2 watt. IRC
 R_{13} —50,000 ohm, 1/2 watt. IRC
 R_{14} —1 megohm, 1/2 watt. IRC
 R_{15} —5 megohm, 1/2 watt. IRC
 R_{16} —10,000 ohm, 1/2 watt. IRC
 R_{17} —.75 megohm, 1/2 watt. IRC
 R_{18} —1000 ohm, 1/2 watt. IRC
 R_{19} —"A" battery meter multiplier (see text)
 R_{20} —"B" battery meter multiplier (see text)
 R_{21} —Db meter multiplier (see text)
 R_{22} —Db meter shunt (see text)
 C_1 —.1 mfd. Mallory

C_2 —8 mfd. Mallory
 C_3 —.1 mfd. Mallory
 C_4 —.05 mfd. Mallory
 C_5 —.1 mfd. Mallory
 C_6 —4 mfd. Mallory
 C_7 —.05 mfd. Mallory
 C_8 —10 mfd. at 25 volts. Mallory
 T_1 —Xtal mike to line transformer. Thordarson
 T_2 —Line to grid transformer. Amertran
 T_3 —Plate to line transformer. Amertran.
 S_1 —Power switch 4P2T. Arrow
 S_2 —Meter switch 2P3T. Arrow
 J_1 —High imp. input jack. Mallory
 J_2, J_3, J_4 —250 ohm input jack. Mallory
 J_5 —Line break jack. Mallory
 J_6 —Monitor jack. Mallory
 X —Rectifier unit from meter

placed when they become low and this is good protection against having to change batteries on the job.

The total "B" drain is 7.2 milliamperes at 90 volts. The total "A" drain is 100 milliamperes on each of two 1½ v. batteries. The batteries used are two Ray-O-Vac P-24A's and two P303A's. The life is sixty hours.

While we are on the subject of batteries, a word of explanation might be in order as to why this amplifier was made strictly a battery job and not a combination battery and a.c. The battery remote amplifier has several advantages over the combination type. Its size and weight are reduced. It affords less of a construction problem, as there is no a.c. hum pick-up to complicate matters. It may be set up anywhere wherever the telephone line is available without the need and inconvenience of the 110 a.c. It's one disadvantage is the cost of operation, and considering the low drain tubes now available, it is reduced to an average of about four cents an hour! All in all, the strictly battery job seemed to afford quite a few advantages, and it has worked out quite satisfactorily.

This unit was designed and built, for use at the Madison studios of radio station *WIBU*. Their ribbon and dynamic mikes are all 250 ohm impedance units and this made possible a saving of the usual mixing transformers. The only mixing transformer used is the "Ouncer," T1 in the diagram, which matches the crystal mike to the 250 ohm load. All mixing is done at 250 ohms, in the indicated series-paralleled circuit, and the signal is then fed into the input transformer, T2. The master gain control (R5) is located between the first and second stages.

Further examination of the diagram will show; regular resistance coupling

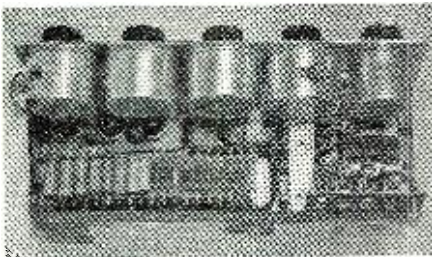

Volume controls are enclosed in cans.

is employed from the first to the second, and from the second to the output stage. The transformer T3 is the output transformer that matches the plate of the 1A5G to the 500 ohm line. At *WIBU* the ungrounded line is used; if the balanced line were employed, there would merely be an added binding post which would be attached to the center tap of the transformer.

Mechanical Considerations

Examination of the photographs will show the construction of the unit. The various controls are, (left to right) top row: "Monitor" jack, power "Off-On," meter switch "A-DB-B," and the

(Continued on page 50)



Manufacturer's Specifications

Make: Speak-O-Phone.

Model: 1-52-A.

Manufactured by: Speak-O-Phone Recording and Equipment Co., 23 W. 60th St., New York City.

Motor: Synchronous type. Standard 110 volts, 60 cycle.

Turntable Speeds: Both 33½ and 78 RPM.

Cutting Head: Especially designed to cut on Acetate or Aluminum.

Drive: Idler pulley type to absorb mechanical vibrations.

Feed: Cutting arm driven by an adjustable friction clutch.

Reproduction: A high-grade recording amplifier with 4.2 watts output.

Microphone: High quality crystal with heavy-duty stand.

Turntable: Extra heavy 15 lb. 12" table for steady torque.

Remarks: Records equally well on both aluminum and acetate discs. Uses the heaviest turntable to be found on any portable recorder at this writing. Has a self-contained recording amplifier that is considerably better than normally used in similar equipment.

Description

The Model 1-52-A instantaneous portable recorder has been designed specifically for those individuals desiring a close approximation of professional recording. Of primary thought in design, of this particular model, the following were considered of extreme importance; Ease of operation and control. Flexibility—

1. Must act as amplifier for sound reinforcement for stage pick-up, etc.
2. Must record equally well on both aluminum and acetate discs.
3. Must be light, self-contained and easily portable.

The component parts of the recorder must be of the highest quality, i. e. the amplifier, cutting head, pick-up arm and turntable.

The recorder must be designed for operation on BOTH 78 and 33½ RPM.

The mechanism used in Model 1-52-A recorder consists of the heaviest turntable now used on any 12" recorder on the market and actually is heavier than most 16" recorders. The weight of this turntable is 15 lbs. Spindle bearings, spindle size and the machining of the turntable proper is held to such close tolerances that the maximum possible wobble in the turntable is less than one thousandth of an inch. The design of the turntable is such that most of the weight of it is distributed around the rim, thus putting into practice the old established theory of recording; that a turntable must actually be a flywheel.

A novel feature of the mechanism used in the Model 1-52-A is the ease with which it can be changed from 78 to 33½ RPM. All that is necessary to do is to remove the turntable and turn the idler pulley upside down. This reduces the speed to 33½ because the drive shaft of the motor is machined to a smaller diameter on one section.

Another novel feature but one that is very important, when one views the trouble heretofore experienced by all semi-professional recorders on the market, is that the cutting arm, instead of being gear driven, is driven by a frictional adjustable clutch. This drive is positive and prevents unnecessary wear and stripping of the drive gears and at the same time permitting of better and quieter recordings. The cutting arm used on this unit is also adjustable by means of a small thumb-latch which permits recording on either acetate or aluminum just by merely locking the latch, thus putting the entire weight of the cutting arm and head onto the

needle point or releasing the latch, thus taking off the complete weight and permitting only the weight of the cutting head to be applied to the disc being cut. All bearings necessary for this function are very closely machined so as to prevent any side play being set up.

The amplifier used in this recorder is actually a recording amplifier and is not just a P.A. amplifier converted for use with a recorder. A 6" speaker is built into the case for use in playing back the recording or for use when using the unit as an electric phonograph. An additional two-circuit jack is provided in the circuit design in such a way that a remote speaker can be used. Due to the fact that the amplifier, as a playback amplifier, has an output of 4.2 watts a speaker up to 12" in diameter can be used very effectively.

The model 1-52-A recorder is complete in every way and consists of the recorder proper, latest type crystal microphone and heavy duty floor stand. Total shipping weight is 40 lbs.

COMMENTS: Many recorders have been tested "under fire" by the writer. Some of these were very satisfactory in some respects, but lacked in others. The Model



Speak-o-Phone Model 1-52-A.

1-52-A Speak-O-Phone recorder is one of the best we have had to date. Those who do recording as a profession and those who seriously study this type of equipment, all know how important the table structure is. First of all—the table must possess sufficient weight to revolve smoothly and without the slightest waver for good reproduction. This recorder meets this requirement to the letter and no trace of "wows" was detected by standard test recording methods. Next in line of importance is the flexibility of this machine. It is a simple matter to change over from a speed of 78 RPM to that of 33½ RPM. This is an advantage when one encounters a wide variety of recording in the studio. Then too—the fact that the cutting head may be adjusted instantly for either aluminum or acetate records is well worth mentioning. I might mention that recording on aluminum requires considerable weight to be placed on the cutting needle which is

(Continued on page 53)

The Vacation Special

by WILLIAM S. HAYES, W6MNU

Oakland, California

Just the thing to take on your vacation to keep you posted on what is going on in the world. Battery drain is very low.

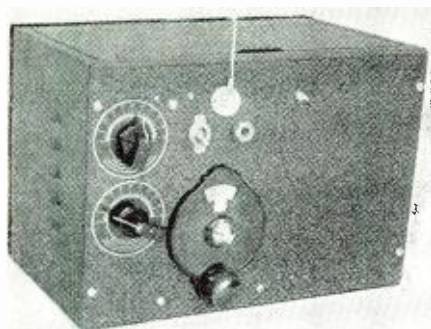

The outside of the set shows that it is simple to tune, easy to build.

FOR a number of years, when radio was even younger than it is - - now, batteries were used almost universally for "A," "B," and "C" supply in receivers. Then along about 1927, the public was introduced to the convenience of a.c. operation, and people within the reach of electric power were quick to hang their receivers on the line and drop their batteries out the window. So it went on, with batteries becoming more and more a thing of the past, until about a year ago when the sale of battery receivers began to come into its own again, much to the delight of the carbon companies, no doubt. This sudden increase has been due in part to the recent introduction of the 1.4-volt series of battery tubes, which has made possible the construction of battery receivers having a very high order of battery economy.

The receiver here described consists of a 1N5G r.f. pentode in a standard regenerative detector circuit, followed by a single stage of pentode audio using a 1A5G. The circuit is simplicity in the extreme, and consists of only four resistors, nine condensers (including the variables), an r.f. choke, an audio choke, and the plug-in coils. The coils are a four-prong set covering 10 to 560 meters in six ranges when tuned with a 140 mmfd. band-set condenser. Since these sets are available from a number of manufacturers at very reasonable prices, no coil winding data will be given here. Those interested in winding their own will find appropriate data in the various handbooks.

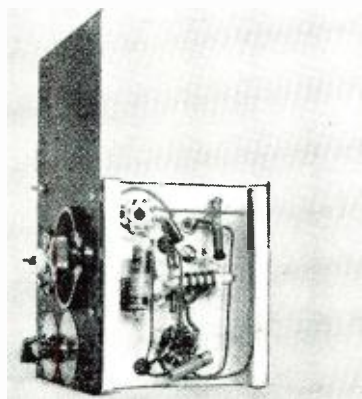

Underchassis view shows easy wiring.

Band spread is obtained by shunting the 140 mmfd. band-set condenser with a 15 mmfd. variable. This provides adequate spread of the amateur bands when used with a suitable dial. Regeneration is controlled by varying the screen voltage, and the detector enters regeneration smoothly without noticeable clicks or thumps. Conventional choke coupling is used between the detector and the audio tube. In order to eliminate fringe howl, it will probably be necessary to connect a 250,000 ohm resistor across the coupling choke. This resistor should not be any smaller than is just necessary to eliminate the howl, since too small a resistance will by-pass a large portion of the detector's output. The audio amplifier uses a fixed bias of $4\frac{1}{2}$ volts and 90 volts on plate and screen, and the output is in the neighborhood of 100 milliwatts.

The Antenna

In the interests of easy portability, it was decided to make the antenna as short as possible. A piece of No. 12 tinned copper wire about 20 inches long was found to give ample pick-up, (Continued on page 50)

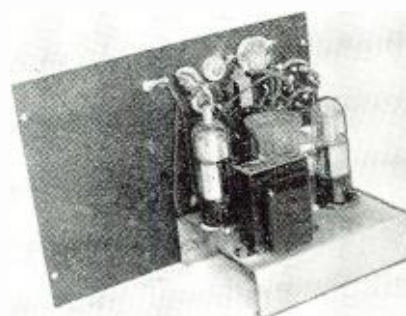

Space at the left is for batteries.

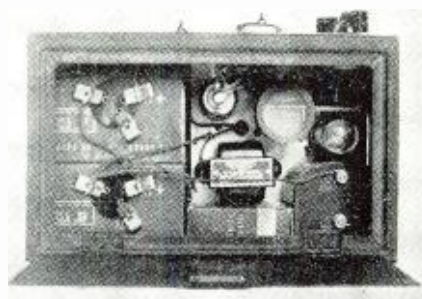

Ready to go—batteries 'n all.

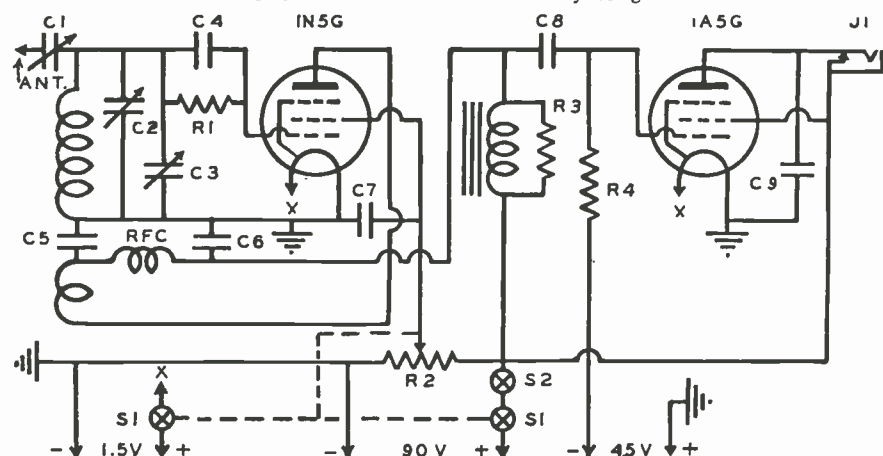

C₁—10-70 mmfd. mica trimmer. Hammarlund 1BT-70.

C₂—140 mmfd. midget. Cardwell ZU-140-AS

C₃—15 mmfd. midget. Cardwell ZR-15-AS

C₄, C₅, C₆—100 mmfd. mica. Cornell-Dubilier 5W

C₇—4 mfd. 150 volt electro. Aerovox "Dandee"

C₈, C₉—.01 mfd. 400 volt paper. Cornell-Dubilier DT

R₁—5 meg. $\frac{1}{2}$ watt. IRC BT- $\frac{1}{2}$

R₂—50,000 ohm pot. Centralab 72-103

R₃—250,000 ohm, $\frac{1}{2}$ watt, IRC BT- $\frac{1}{2}$ (see text)

R₄— $\frac{1}{2}$ meg., $\frac{1}{2}$ watt, IRC BT- $\frac{1}{2}$

L—Four-prong plug-in coils. Hammarlund SWK-4

RFC—2.1 mh. Hammarlund CHX

CH—1080 hy. audio choke. Thordarson T52C98

S₁—DPST switch on reg. control. Centralab

S₂—SPST toggle switch. Arrow

J—Closed circuit jack. Mallory

Cabinet—Bud No. 993

Chassis—Bud No. 776 (see text)

Batteries:

"A" Burgess Little-Six

"B" Eveready No. 762

"C" Eveready No. 771

Tubes: RCA

Dials: National "BM" and ICA dial-plates and pointer knobs.

Feed-through insulator: Johnson Alsimag No. 55

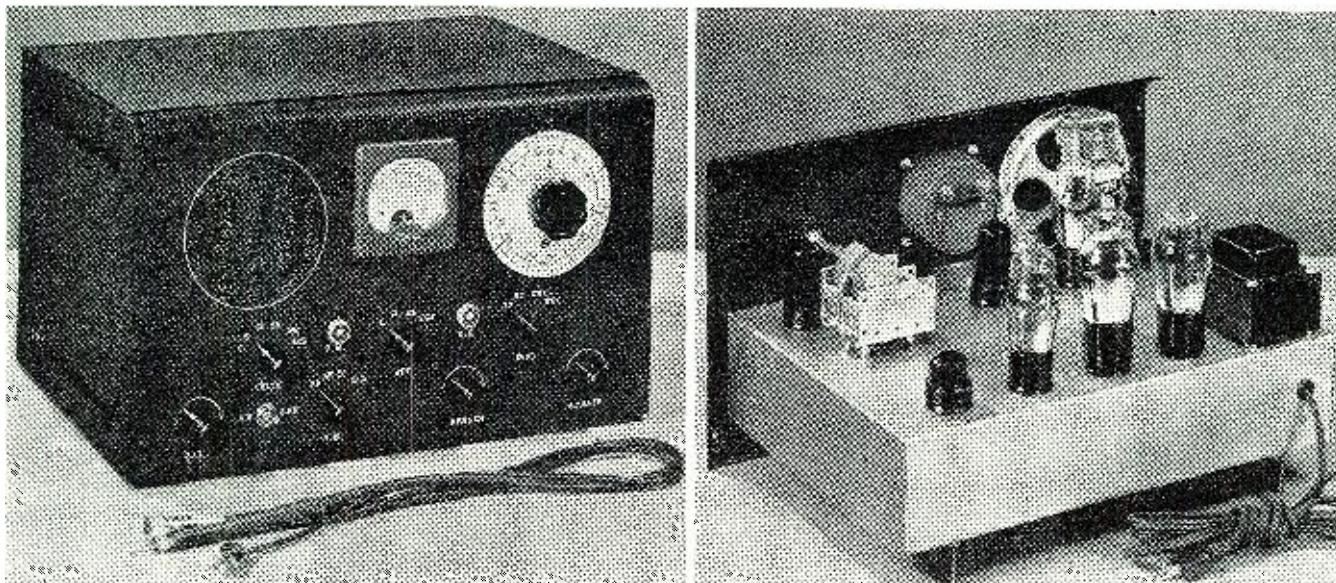

For a commercial-looking signal tracer, this one will please every serviceman. It is easy to build and will help in the location of "bugs" and set trouble.

A SIMPLE SIGNAL TRACER

by **R. K. WHEELER**
Indianapolis, Indiana

Unlike many test instruments, this unit is one of almost universal utility, that can be profitably used on nearly every repair.

THE subject of test instruments is one of ever-present interest to the radio man, although past sad experience has taught him to accept with some reservation the enthusiastic claims of the salesman. However, the newest test instrument, the signal tracer, requires only a brief demonstration to sell itself to the radio man as one of the most useful instruments devised to date. Unlike many instruments, the signal tracer is one of almost universal utility, that can be profitably used on nearly every job, as not only the ordinary routine tests can be made, but a number of heretofore difficult time-consuming tests may be made with great rapidity and ease.

During the past year a number of dynamic signal tracing devices have

appeared in various forms that may be confusing to many. While the instrument is new in development and application, it is not new in principle, as it is essentially a vacuum tube voltmeter, with one or more tuned stages of radio frequency amplification ahead of it, or in some case only a tuned r.f. receiver, with a volume indicating device, such as the "tuning eye" tube.

To the average man, accustomed to the use of moving coil meters, the type employing an electronic voltmeter will probably have the most appeal, especially since the voltmeter may be made readily accessible, by switching, for external measurements of d.c. voltages, with negligible current-draw.

While the value of the signal tracer as a service tool cannot be seriously

disputed, to a large number of men, present prices will be somewhat prohibitive, and the purpose of this article is to describe the construction of a practical instrument that may be made from generally available parts. By reference to the schematic diagram, it will be seen that it consists of a two stage tuned r.f. amplifier, with a single tuning dial, covering the frequencies between 55 kc. and 17 mc. in five bands. A 6H6 tube is used as a dual detector, one section applying rectified signal voltages to the VTVM, as well as supplying a.f. through two-stage amplifier to the monitoring speaker. The second section of the 6H6 is connected to the VTVM switch, and is used to rectify external a.f. voltages for measurement by the meter.

There are three principal problems in the construction of a serviceable signal tracer: a suitable input arrangement and attenuator, the r.f. coils, and the measuring device or voltmeter, which will be discussed in that order.

The capacity of the shielded test lead required for picking up r.f. signal voltages, is added to the input circuit capacity, and forms a considerable source of loss. The small co-axial cables such as made by *Amphenol* are the best available for this purpose at present, having comparatively low capacity between the conductor and shield, about 12 mmf. per foot, and very low di-electric losses. A made-up test cable of this type, complete with special probe can be obtained from at least one manufacturer (*Carron*). Ordinary single conductor microphone cable may also be used, but should be of good quality, and rather limited in length to reduce the total capacity as much as possible. Several samples of such cable were tested, and most averaged around 30 to 35 mmf. per foot. The rating given for *Belden* cable is 27 mmf. per foot, while one sample

of unknown make was found to have nearly 50 mmf. per foot capacity. All samples were shielded single conductor, with rubber cover over-all.

When measurements are made across tuned circuits, the input capacity of the instrument must be isolated as much as possible from the circuit under test, to avoid serious de-tuning of the circuit. According to present practice this is done by installing a very small condenser, about one or two mmf., in the test probe, in series with the lead. This results in a considerable reduction of sensitivity, in direct proportion to the ratio between the input shunt capacity, and the small series capacity. In the case of the unit shown, the input capacity with the test lead connected is approximately 100 mmf., and the series capacity is 2 mmf., which reduces the sensitivity by a factor of 50:1.

The shield must be grounded to the chassis, and the *Amphenol MC-1* connectors provide an efficient method of doing this, besides presenting a professional appearance at low cost. The 2 mmf. series condenser should be very small in physical size, and located as near the business end of the test probe as possible. One method of obtaining this capacity is shown in the accompanying sketch. A small strip of $\frac{1}{16}$ " bakelite is placed between two thin pieces of copper about $\frac{3}{8} \times \frac{1}{4}$ ", in such a manner that the copper strips overlap about $\frac{1}{4}$ ". A small hole drilled through

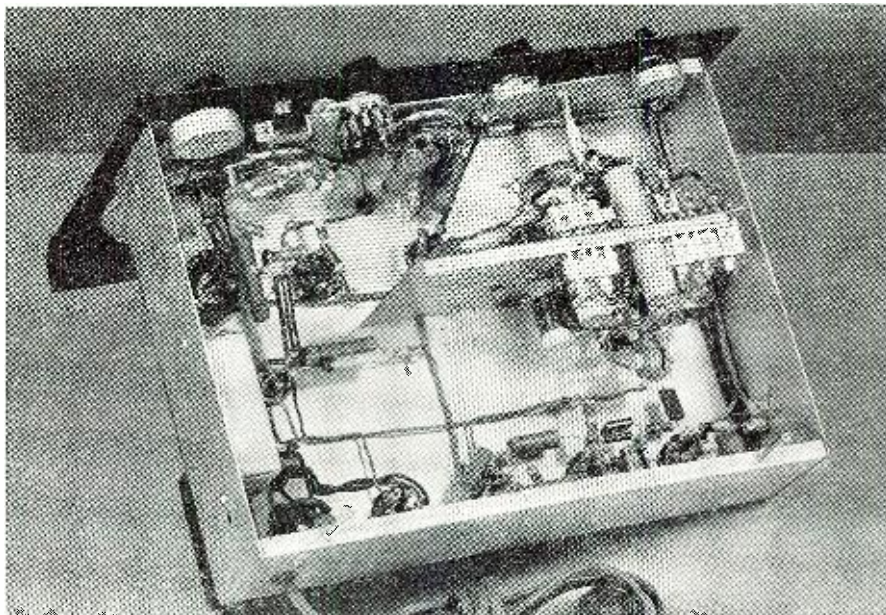

The cleanliness of the layout and the wiring materially help not only in the construction, but add to the efficiency of the unit as well.

the bakelite and copper at each end of the assembly will permit the conductor of the cable to be looped through one end and soldered, and a very short lead soldered to the other end for connection to the test point. The edges may then be rounded off with a file sufficiently to allow the assembly to fit snugly in the hollow han-

dle of the test prod. The condenser should be pulled down closely to the tip, and when soldered to the tip will anchor the cable securely in the prod handle.

A similar cable should be made up for measurement of a.f. voltages, but omitting the small series capacity. This cable may be also used when

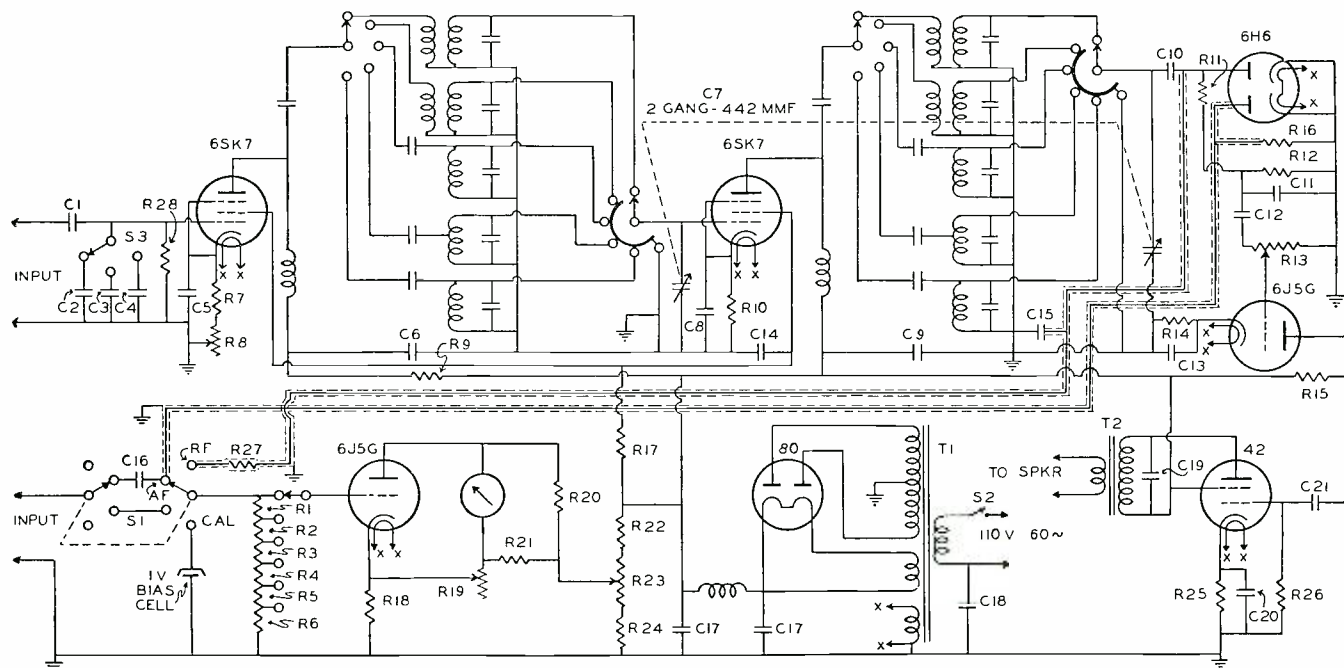

- R₁—10 megohms, 1/4 w. IRC
- R₂—2 megohms, 1/4 w. IRC
- R₃—250,000 ohms, 1/4 w. IRC
- R₄—200,000 ohms, 1/4 w. IRC
- R₅, R₆—25,000 ohms, 1/4 w. IRC
- R₇—250 ohms, 1/2 w. IRC
- R₈—5,000 ohms, wire-wound, Mallory
- R₉—1,000 ohms, 1/2 w. IRC
- R₁₀—400 ohms, 1 w. IRC
- R₁₁—200,000 ohms, 1/2 w. IRC
- R₁₂—250,000 ohms, 1/2 w. IRC
- R₁₃—500,000 ohms, pot. Mallory
- R₁₄—4,000 ohms, 1 w. IRC
- R₁₅—250,000 ohms, 1 w. IRC
- R₁₆—1 megohm, 1/2 w. IRC
- R₁₇—40,000 ohms, 1 w. IRC

- R₁₈—500 ohms, 1 w. IRC
- R₁₉—50,000 ohms, pot. Mallory
- R₂₀—15,000 ohms, 1 w. IRC
- R₂₁—10,000 ohms, 1 w. IRC
- R₂₂—5,000 ohms, 10 w. Ohmite
- R₂₃—5,000 ohms, wire-wound, Mallory
- R₂₄—10,000 ohms, 10 w. Ohmite
- R₂₅—400 ohms, 1 w. IRC
- R₂₆—500,000 ohms, 1 w. IRC
- R₂₇—1 megohm, 1 w. IRC
- R₂₈—250,000 ohms, 1/2 w. IRC
- C₁—.05 mf. 400 v. tubular. Sprague
- C₂—.001 mf. 400 v. tubular. Sprague
- C₃—.01 mf. 400 v. tubular. Sprague
- C₄, C₅, C₆, C₈, C₁₄—1 mf. 400 v. tubular. Sprague

- C₇—2-gang 442 mmf. var. Meissner
- C₁₀—.0002 mf. mica. Sprague
- C₁₁—.0005 mf. mica. Sprague
- C₁₂, C₂₁—.01 mf. 400 v. Sprague
- C₁₃, C₂₀—10 mf. 35 v. electro. Sprague
- C₁₅, C₁₈—.05 mf. 400 v. Sprague
- C₁₆—5 mf. 200 v. Sprague
- C₁₇—8 mf. 450 v. electro. Sprague
- C₁₉—.006 mf. 400 v. Sprague
- SW₁—2 pole, 6 position sw. Mallory
- SW₂—SPST toggle. Arrow
- SW₃—Single pole, 4 position sw.
- T₁—Plate and fil. trans. Thordarson T70-R-20
- R₂—Output to voice coil. Utah
- Spkr.—Utah 5" dynamic, 1,000 ohm field.

making d.c. measurements. When testing circuits of low r.f. potential, such as antennae, by-pass condenser, etc., the full sensitivity of the instrument will be useful, and an unshielded lead may be used for this purpose.

The condensers for the r.f. attenuator are selected to attenuate a given signal by factors of 10, 100 and 1,000. The value of these condensers will de-

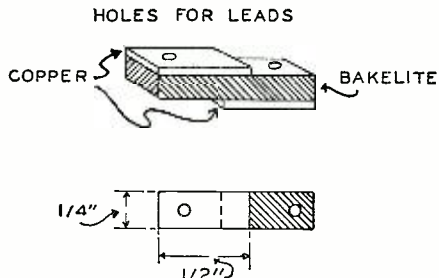

DETAIL
2 MMF. CONDENSER
Condenser construction details.

pend upon the total minimum shunt capacity across the input, with the test cable connected. If the builder has no facilities for measuring this capacity, it may be easily determined after the instrument is completed and operating, by applying a strong steady r.f. signal to the test prod, sufficient to produce about 10 to 20 volts reading on the meter. Condensers around .001 to .002 mf., may then be connected experimentally across the grid circuit of the first r.f. tube, until the meter reading is reduced to approximately one-tenth of the original reading. The size of the condensers required for the remaining steps is then easily established.

If the condenser required is not a stock value, such as, .001, .0015, etc., the minimum circuit capacity may be adjusted by shortening or lengthening the cable until the desired results are

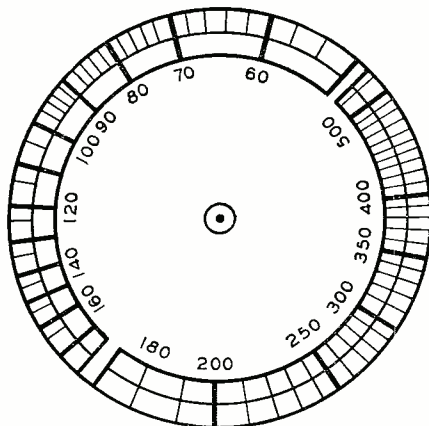

Dial layout detail.

obtained. If microphone cable is used, and the length held to around 30-36 inches, the minimum shunt capacity will be about 100 mmf. to 150 mmf.

It is obvious that the value of the instrument will depend largely upon
(Continued on page 41)

UTILITY RADIO DEVELOPMENTS

In response to many requests we herewith give our readers the additional service of the latest news in the utility radio field. While this column will be of great interest to all radio-minded persons, it will be of particular interest to the professional radio engineer and operator. Here you will find the latest developments in that division of radio which most nearly affects the every-day life of the nation, the Police, Marine & Aviation Radio. We will be happy to answer all questions we can regarding the news in this column, but please mention the issue and the name of the manufacturer when writing.—The Editors.

Police Radio

PIERSON-DELANE, Inc. of Los Angeles, Calif. presents a new addition to their line in the *Model PR15-UH* which is of the super-heterodyne type employing two stages of high gain RF preselection. It has a separate heterodyne oscillator equipped with temperature frequency compensator, assuring freedom from frequency drift. High conversion modulator, two stages high gain intermediate amplification with band width adjustable at the factory from 10 to 50 KC.

This "central station receiver" was designed especially for police departments and has automatic volume control (high speed,

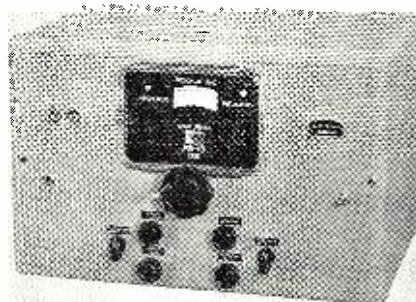

extremely efficient) push-pull beam power output stage, delivering 12 watts with distortion less than 2%; audio filter is incorporated, cutting off all frequencies above the usable speech range; automatic threshold noise silencing circuit removes ignition noise and other forms of man-made static; inter-channel noise suppression (squelch) for silence-between-transmissions. It has double trigger action and is very positive in operation.

The receiver is tunable between the frequencies of 30 and 40 megacycles; accurately calibrated dial. Accurate mechanical band spread, assuring exact logging and checking. 400 to 1 tuning ratio for ease of setting. Tuning condenser is double spaced with stators Isolantite insulated; power supply designed for 24 hour duty; an unmounted 12 inch heavy duty electro-dynamic speaker is supplied with this receiver.

This receiver is equipped with accurate "R" meter (field strength indicator), 14 tubes and operates on 110 volts, 50-60 cycle AC. It can be supplied in any other frequency or line voltage. Due to the development of a specially high efficient silencer circuit it is able to give perfect reception in the noisiest

areas. The receivers in both cars and main station are dead silent between transmissions. This receiver is custom built and all by-pass condensers are either bakelite moulded or Isolantite encased; all inductances are wound on *Hi-Q* material, double lacquer impregnated and baked to assure absolute imperviousness to moisture and permanence of characteristics.

DOOLITTLE & FALKNOR, Inc., 7421 South Loomis Boulevard, Chicago, Illinois, manufacturers of radio transmitting equipment and associated apparatus have available a complete line of transmitters and receivers designed specially for Police Communication.

The *CF Series* Transmitters are supplied for fixed station use on either the medium frequencies (1600 to 3000 Kcs.) or high frequencies (30 to 40 Mcs.). Output powers range from 50 watts to 500 watts.

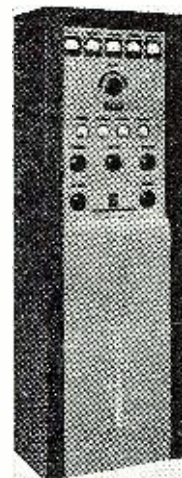

Mobile transmitters are supplied in three different models all for operation between 30 and 40 megacycles. The *15W*, illustrated, utilizes tubes of the indirect heated types. Another model, the *15X*, employs filamentary type tubes which because of their quick heating properties need not be maintained at operating temperature except when the transmitter is actually in use. This innovation lengthens car battery and tube life. A low priced mobile transmitter, the *15Y*, is

offered for small towns that require only limited coverage for most applications.

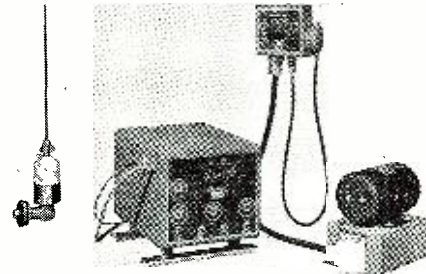

offered for small towns that require only limited coverage for most applications.

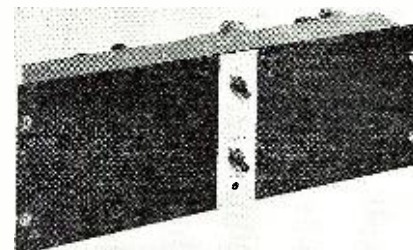

The latest to the line of receivers
(Continued on page 58)



by **LEE WARD**

Service Manager, San Francisco, California

Herewith another of Mr. Ward's interesting Repairman's Riddles. The problem presented is a common one, and the solution workable.

OF all the distractions which reduce the effective length of a store-owner's day, the idle but voluble dropper-in is probably the worst.

This type of fellow ranges from the rankest tyro who stops off to tell you how he got St. Louis on a bedspring (with a set he bought from someone else) to the enthused crank who has just given birth to a brainchild, and who insists you stop work to admire the brat. The latter sort usually has enough technical background to be poisonous.

These walking doldrums have a common effect: once in your store, they result in a commercial calm. The problem of getting rid of them is complicated by the possibility one of them will eventually get around to buying something or giving you a call.

How do you cope with these blokes to earn

a living? Read the narrative below and answer the questions at the end. Bring as much of your field experience as possible into play, for your entry will be judged for practicability, accuracy, and for its usefulness to other servicemen-readers.

As was previously pointed out, these are REPAIRMAN'S Riddles. You need not be a subscriber, store owner, nor serviceman to enter; but all entrants must concede it is fair to appraise answers on a basis of their worth in a radio store. Everyone except employees of Ziff-Davis Publishing Company or their families is eligible. Duplicate prizes to tie winners. Judges: Editor of RADIO NEWS whose decision is final and binding.

Address entries to Repairman's Riddle No. 7, RADIO NEWS, 608 South Dearborn Street, Chicago, Illinois. They must be received not

later than August 25, 1940 to qualify, and the winners will be announced in the November issue.

FIRST PRIZE: Choice of either a Triplett Model 426 0-1 d-c milliammeter, 4" square, a Simpson Model 29 with the same scale, or any other meter of the same retail value you choose.

SECOND PRIZE: Ghirardi's headache preventer for servicemen, the famous Radio Trouble-Shooter's Manual.

THIRD, FOURTH and FIFTH PRIZES: Each a year's subscription to RADIO NEWS. If you are already a subscriber, a 12 months' extension.

And now let's see how Cliff might have saved a lot of trouble if he hadn't taken the day off. The scene, Ward's radio store. QUIET, please! The time, Saturday afternoon.

OF all the counter-irritants I have come across in my experience as store manager, I believe the one that got me the maddest was the fellow who went to work on Pete, my man Friday, last Saturday. Cliff—my "pick-up" man—had taken the day off to attend a meeting of the *Hired Help of America*.

Pete is a good technical man, and *should* have been able to contend with the intruder successfully; but he was an exceptionally stubborn case.

I was sitting at my desk, minding what was left of my business, when we heard this jasper jump over the jamb. Pete left his work on the bench and went out front.

"What can I—" he began.

"I will come directly to the point," the pseudo-customer said, voicing what we later learned was a meaningless boast. "I am Mr. Kane, of Hillside Avenue. Ever notice the spherical metal antenna on the roof of the green house near Schiller Street?"

"No," Pete replied, "can't say I—"

"It's mine. Makes the best aerial you ever saw; reduces fading on short waves like all-get-out—you ought to try it sometime. Improves tone quality, too. As I was saying, I noticed your truck pass the house several times last week. It has the address of the store on the side, you know."

"Yes," admitted Pete dully, "we put it there on purpose."

"—and so I often thought of drop-



The serviceman might have to go to the crystal ball for a solution.

ping in to see you. Here I am!"

I didn't remember any Kane on our customer list, and he was beginning to get my goat. I stuck my head out from behind the partition to see if I recognized him. I didn't, but he saw me and spoke like I'd known him for years.

"Ah, hello there!" he said, walking back into the shop. "Swell place you have here."

"It's not much, really," I replied, "but we are old-fashioned, and like to think of it as a place of business. You know — just a little hide-out, away

from the mob, where we can go when there's a bit of work to be done."

But sarcasm doesn't frighten *his* kind.

"Yes, sir," he continued, as if I hadn't spoken, "by the way—did you know a soldering iron heats up more rapidly on d.c. than on a.c.? And it *stays* hotter, too."

"My license is revoked," I snarled. "Better tell my technician."

"If the heating element—" Pete attempted.

"I should think," Kane said, "it would be worth-while for you fellows to have a d.c. line installed for that one reason. There are lots of things like that which can be used around a shop. Some save money, and others are interesting."

I reached for a *Victor 32* filter block with a threatening gesture, but with no effect.

"Take, for instance, an ordinary water bucket. Do you know it may be used as a rheostat when you don't happen to have a variable resistor? Simply fill it with salt water and dip the two resistor leads in. Starting with them close together in the center of the liquid, the circuit resistance becomes greater as the distance between them increases." Kane smiled.

"When Mr. George J. Ohm laid down his law," I remarked, "I'll bet he never thought you would try to repeal it in 1940." But Kane continued.

(Continued on page 44)

Serviceman's Experiences

by **LEE SHELDON**

Chicago, Illinois

**Cut-rate radio installation—specially in an auto—
is a one-way ticket to ruination; as Lee finds out.**

Al and I have been in partnership for years, and yet he always treats me like a beginner. Whenever he leaves me alone in the shop, he gives warnings and counsel that are sickeningly obvious to a man of my experience.

Lately he's been stressing the idea we should never boost a bid on a repair job; that it's better to stick to the original price and take a shellacking than to lose customer confidence by a lift after both parties have agreed on the first price. He preaches this concept so frequently I often think he has a one-track mind.

Al always regards himself as senior executive of *Salutary Sales & Service*, and his dictatorial methods are disgusting. Last Friday, when he took the truck to deliver an amplifier to Wet Lake, it was: do this; don't do that; be sure to do so and so.

"I worry," was Al's farewell, "when ever you are alone in the shop, for you are a drugged individualist."

I can run the shop as well as he, and he knows it. Further, I can be a gentleman—even to a business partner — so I just stood there, burning slowly.

"In short," he added, "don't get any ideas while I'm out. With business the way it is, we can't afford them. Remember the last time I was away—the day you pulled the tube shelves from the wall in an attempt to file tubes by number instead of letter?"

It was true; but what angered me was that his tone implied I must have enjoyed myself when I fell on the back of my face. He then left, mistaking my silence for defeat; but, before the end of the truck disappeared, I was casting about for some means of distinguishing myself commercially before his return.

Providence, in the form of an old *Chevvie*, soon came to my assistance. It stopped before the store, gave a few post-mortem jerks, and disgorged a driver. He walked into the store with an auto radio hanging across his arms.

"Just picked up a second-hand set cheap," he announced, "and I want it installed. How long, and how much?"

I thought rapidly: our nearest competitor's standard price was four dollars; I'd have to underbid to be safe. Besides, I wanted at least one job showing on the books before Al showed up. There's nothing like a little cash-

drawer activity to forefend criticism. "Is there an antenna in the roof?" I asked.

"Yep," he said, "the lead-in comes down along the left side of the windshield."

"Three bucks," I announced, "and call for the car at three."

"Okay," he agreed, and walked away.

With characteristic verve, I set to work immediately. The set was in three pieces: remote control, chassis and speaker. I made a paper template of the chassis studs, raised the left hood, and marked the dashboard. When I looked for the electric drill, I remembered Al had taken it with him. It was a tough job, putting three holes through with nothing but a speed drill and brace and bit, but I figured it was worth a little extra suffering to be able to work without my partner's heckling.

The remote control had been made for a larger steering column, and there were no leather shims, so I had to use tape to fill up the extra space. Didn't look any too good, but I thought it probably wouldn't be noticed because it matched the general sloppiness of the rest of the car so well.

There was a little trouble with the

tuning control cable. Evidently its previous owner had lent it to a Boy Scout for knot-tying practice, for the kinks made the drive load much greater than normal. I got around that by putting a larger knob on the control shaft. There wasn't any room for a matching knob on the volume control shaft, so I had to leave the old one there. A bit unbalanced, but it worked.

I was temporarily discouraged when I found that, although the two top chassis studs matched the holes, the bottom one didn't. For a while it looked as though the template had slipped; but then I found it had only been reversed, throwing the bottom hole a little to left of center, instead of a little to the right.

The novel manner in which I overcame this difficulty might be of interest to the trade, and I pass it along: I simply sawed off the bottom stud. This expedient allowed the bottom of the chassis to wave up and down, like a mailbox flap, but I minimized the movement by wedging in some old tube cartons, folded twice.

With only one mounting stud on the speaker, there was little bother with making a template, and less danger of reversing it. The speaker stud, however, was very short, and I experienced considerable difficulty in holding it against the dashboard while I screwed the nut on from the front. Every time I propped the thing up and tip-toed around, the speaker fell. Finally I sawed off a length of two-by-four and used it as a buttress between the speaker grille and the back of the seat. This held it firmly, and the nut went on without any trouble; but when I removed the board, the speaker again fell. I had screwed the nut on the water heater.

Next, the A connection. There was such a growth of fungus on the hot terminal of the battery the entire lug came adrift from the cable as I unloosened it. Tempus was fugiting, so it was quicker to go to the nearest battery store than to start up the torch and sweat the old parts together. I got one for only \$1.50; store owners in our neighborhood understand each other.

As the customer said, the antenna lead was coiled up under the left side of the instrument panel. To make
(Continued on page 56)

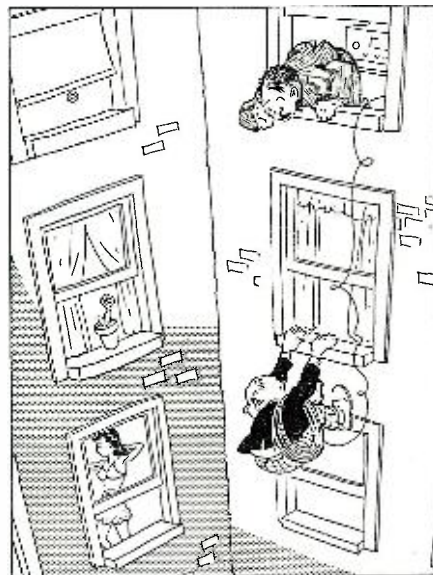

"Hey, you dope, the antenna goes up—
you know, UP—the other way. . . ."

Ring the Bell

The set repair situation, and what it means to the serviceman in \$ & c.



by SAMUEL C. MILBOURNE

Expert Serviceman, Greenwood, Miss.

How much should you charge to repair a radio receiver?

Here is a question that will start a verbal argument in any service group. In tackling the problem let us first get certain things straightened out in our minds.

First, it must be assumed that the serviceman is full-time employed and that he is making his living solely from radio repairs.

Second, it must be assumed that the serviceman *over the full year* has a sufficient number of repairs to stay in business. This means that he is kept at least moderately busy all the year.

Third, it must be assumed that the serviceman is reasonably well equipped in knowledge and shop equipment to make repairs within an average time.

Now, let us next disassociate in our minds parts (including tubes) and labor, i.e., separate *material* and *time*—at least for purposes of this discussion.

We can easily get tangled up at this point by the claim that a bill made out for one single amount which includes labor and material, or the pricing of parts including replacement labor, is more satisfactory than an itemized bill for parts and labor. We are not discussing this point. We are discussing the *ultimate total* regardless of how it may be billed to the customer.

Therefore, for our purposes we will consider first what to charge for parts, tubes, etc., and second, how to arrive at a profitable yet not excessive labor charge.

Did you ever consider the reason a part shows a list price on its container? Did you ever wonder why the tube companies issue tube list prices? Did they pick these prices out of the air?

No—thrice no! List prices on parts and tubes are determined first by the cost of production of the parts or tubes, second by the mark-up necessary to give the manufacturer, the jobber and the serviceman a reasonable profit and third, at times, by the capacity of the ultimate consumer to pay. The third factor is not an important consideration in the mark-up on parts as it is usually used as a determination of the first factor (the original cost of production) and hence the *quality* of the part.

Thus, we find several *qualities* of

parts such as condensers and resistors with identical electrical specifications of capacity, resistance, working voltage, etc. Once more, this angle is beside the point and should not enter into our present discussion.

All right, let us take an example of a capacitor, i-f coil, power transformer or speaker cone. You will find that your costs for reputable replacement parts of this type will average 60% of their list prices. Now a whole industry can't be wrong when, as a body, they recommend a list price which allows a 40% *gross* profit. Therefore, let us assume rightly that *no part should be sold unless at least a 40% gross profit is made on the item!* If you can double your original cost (and there are many localities where this can be done) all the better.

After all, this is only a 20% increase over the previous list. If you buy a part for 60 cents, it should carry at least a \$1.00 list price. If you work on a double-the-cost basis, the list would then be \$1.20—only 20 cents more and nothing for a customer to fight over, but important to you on an annual gross sales basis.

Tubes are usually obtained at about 50% of list. The tube price situation is not looked on with favor by the writer. Tubes list entirely too cheaply.

However, once more, this is beside the point. You should *never* sell a tube for *less* than prevailing list, therefore this gives a double-the-cost basis on tubes.

Do you charge for additional wire when used? Pilot lights? Fuses? It is surprising how few servicemen do. Yet they cost money to buy, exactly the same as more expensive parts. Do you charge for every small capacitor and resistor which you install? You should study a garage bill. Everything is itemized down to the last nut, bolt and fuse—it would be well for you to follow their example.

In other words, get out of your minds the idea of *giving away* any part to the customer—no matter how small, for that is exactly what you do when you fail to charge for small items. This is necessary so that you will “come out” on the mark-up you use.

Many servicemen charge at least ten cents for any part costing them six cents or less. Resistors costing ten cents are often sold for from twenty-five cents to one-half dollar, and the same for very small condensers. Frankly, I have no fault to find with this. Every man knows it's hard enough to keep a complete supply and if you do try to keep an adequate sup-



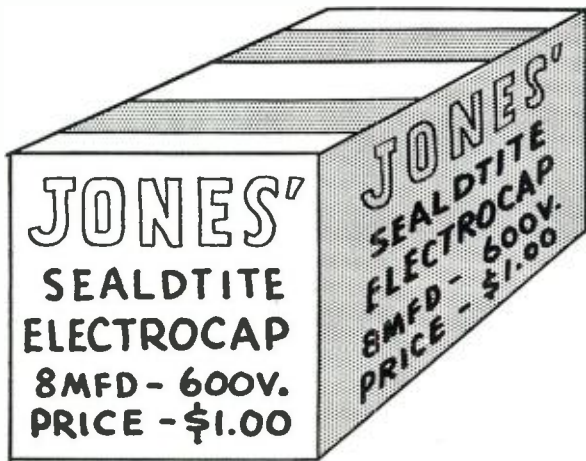

Did you ever figure why the the price is shown?

ply of these smaller items, you are entitled to a greater gross profit on their sale.

Thus, looking back on the discussion so far, we find that:

1. Parts must never be sold for less than a 40% gross profit—preferably a 50% gross profit.
2. Tubes must never be sold at less than prevailing list price.
3. All parts used in the repair should be charged for—regardless of how little they originally cost you.
4. Where you kept a large supply of values of small resistors, fuses, bulbs, etc., you are entitled to a large profit on the sale of one item.

Now, let's take up the labor charge. I don't care how it has been presented to you before; labor in modern industry is paid for according to the time consumed. It may be by the hour, day, week, month or year, but it is definitely paid for according to *time* standards. If you will dig behind the methods used in establishing piece-work rates, you will find that even though the worker is paid by the piece, the original basis is *how long it takes an average worker to do the particular job*.

Hence, when establishing our labor charges, we must base them on *time* and on nothing else.

Now, it is assumed that you, or you and your partner do the actual repair work. Therefore, you are, in effect your own employee. Stand off from the service bench and view yourself as another person. That person must eat,

he must have a roof over his head, he must be suitably clothed, and lastly, he should have enough left to enjoy some of the pleasures of this life according to his disposition. He may be married with a family to support. He may be buying a car on time or any one of a thousand other things. He has to live and to do so he works for a living. He works so many hours a week and should receive a certain amount for that work.

How much is a radio serviceman worth? This depends on many factors, mainly these include prevailing wages and cost of living in the community, age, experience and ability to "turn out the work." As this man is you, you are

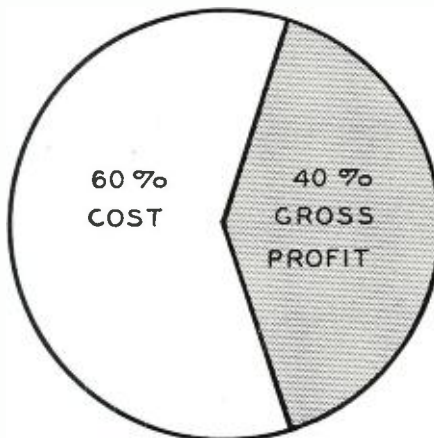

How your income should be divided.

probably better able than anyone else to determine his true worth. Look at it from this angle—*what would you have to pay for a serviceman to take your place?* This serviceman should be equal to you in all respects. Another angle from which to view the situation would be *how much salary could you get if you went to work for someone else?*

Now, we are not going to place a figure on your worth but as we have to use some figure to work out the discussion, let us take one of \$25.00 per week.

High-sounding and entirely impractical Administration ideas on the work-week to the contrary, let's assume that this man (you) works 50 hours a week. This would place his hourly rate at 50 cents. Many servicemen work for less, many for more, but let's use this as a basis.

It is important to appreciate the fact that this 50 cents an hour is your *labor cost* which must go on regardless of good or

bad business. In other words, your stomach and the landlord won't take a Bank Holiday because times are temporarily not so hot. Every week, rain or shine, business or no business, you as an employee must dip into the till and come up with \$25.00 between your teeth.

Therefore, this is a definite cost just the same as the original cost of the parts you sell. *Do not consider it in any other light.* When you work, it doesn't make any difference *whom* you work for—your worth should be the same in any case. If you expect to make only a normal wage from your service business, get out of it and get a job working for some one else. Let *him* do the worrying.

Now the question arises, how much should the spread be between this *labor cost* and *labor list*? Here, unfortunately, we have no radio manufacturers to indicate what this should be. However, it is certainly worth a mark-up equal to parts so that if we say \$1.00 per hour *labor list* on a 50 cent *labor cost*, we are following good precedent.

"Ah!" you exclaim, "I've got you now! How about expenses?"

Yes, there are expenses in the service business. Plenty of them! Rent, light, heat, car, upkeep, taxes and dozens of others — including bad guesses on repair estimates. These can only be appreciated when considered on an annual basis. That's why it is so important to keep books.

Most every serviceman who reads this article has been in business at least a year. If so, he should have a record of two facts. First, the total number of sets he repaired in the last twelve months and second, the *total* amount of money paid out during last year for everything other than parts, tubes and wages.

Let us assume that the total number of sets handled during the last year was 1,200. Many servicemen repair more, many less. Look at your record.

Let us further assume that general expenses were \$100.00 per month and if you think this is high, start adding up your rent, heat, light, car upkeep, etc. This means \$1,200.00 per year, or *one dollar per set*. It further means

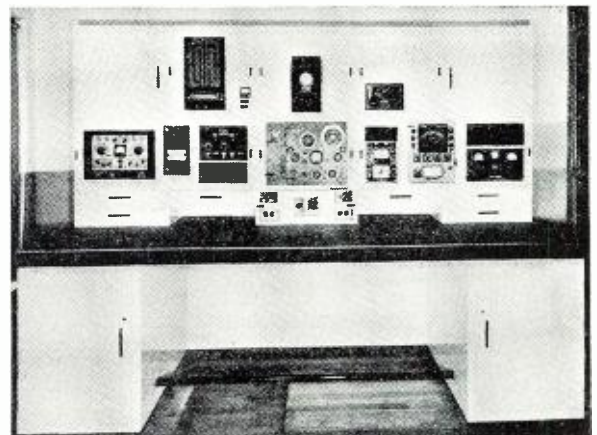

This National Radio Institute Test Bench "Rings the Bell"!

**Cut out and mail to "Ring-
ing the Bell" Department.**
ANNUAL CHECK-UP LIST

1. Total number of hours worked.....
2. Total number of hours charged to customer.....
3. Total number of sets serviced.....
4. Total expenses, less parts, tubes, sets, labor and side-line material costs.....
5. Population of your town.....

Name.....
Address.....
City..... State.....

that aside from any labor or material costs, it costs you *one dollar every time a set comes into your shop*. If your figures show 600 sets per year and \$600.00 general expenses, it *still* averages \$1.00 per set.

Now if this figure is firmly fixed in your mind, you can do one of two things. You can add it to the total bill on each repair, or you can work it out on an hourly basis and add so much to the hourly *labor list*.

For instance, let us assume that you worked 50 hours per week and 52 weeks per year or a total of 2,600 work-hours per year. General expenses were \$1,200.00 for the year or 46 cents per hour, regardless of whether you did business or not. You can add a certain amount to each *charged* labor hour—for the present let us just add the 46 cents. That's \$1.46 per hour for the new labor list.

Now, here is the stinger. You didn't *charge* for every one of those 2,600 work-hours, did you? How many did you *charge* for? One-half? Figure it up and you'll be surprised. Now let's see what we have. 2,600 hours-per-year worked. 1,300 hours actually paid for. 50 cents per hour labor and 46 cents per hour overhead times two equals \$1.92 per hour actual cost! And you think \$2.00 per hour is too high to charge for labor!

Now, it is true that there is one fallacy in the above setup. Nothing has been charged against the parts gross profit for expenses. That is true, but the serviceman has to make his profit some place—and he has to have a place from which to recoup his losses.

Actually, it is easier to follow the idea of a fixed charge on each set for overhead, that is \$1.00 per set or whatever amount your annual expenses divided by the number of sets serviced amounts to. However, don't forget to base your per-hour labor cost on the number of *charged-hours*, not *worked-hours*.

One last thought. Never do a job at less than your figured cost! You may kid yourself into believing that you can make it up on the next radio, but if you charge wisely, *you are already charging all the job is worth* and you will certainly run into trouble if you try to "equalize" one repair against another. Leave the fifty and seventy-five cent type of service to the next fellow. Let him take the loss. Spend that time on promoting more profitable radio repairs. You will find that it will work out much more profitably for you.

Remember that the figures used in this article are merely for illustrative purposes and are not offered as "standards." Your labor worth, your expenses, the number of sets you repair a year, and the total time you *charged* for will determine them for you.

Figure yours and then apply them to your business. Don't "chisel" yourself—that's where all good plans can fail.

(Continued on page 56)

SERVICEMEN'S LEGAL ADVICE



Ed. Note: This is a new department devoted to a discussion of the legal problems confronting the serviceman. In it only those questions of interest to the field as a whole will be published. Feel free, however, to write the author your inquiries. While it will be impossible to give any legal advice to individuals, still those letters of interest to all servicemen will be printed together with proper answers wherever possible.

LAST month we discussed the subject of sales from a simple angle. No attempt had been made to go into the subject deeply, and only a smattering of the subject matter was tried. When a sale is made, payment is generally expected, and usually is forthcoming. Sometimes, when the serviceman makes the payment he gives a note and sometimes when he sells radio equipment he takes a check or a note in payment. So this month we will talk a bit about notes and checks.

In most of these United States the treatment of notes and checks is a matter of statutory law usually termed the "Negotiable Instruments Law." This law (called the N.I.L. by lawyers) is more or less uniform throughout the country, and so while only examples applying to the state of Illinois will be given, still it will be found that most of the other states' laws are mostly the same.

Before any discussion of a note can be had, it is necessary to know just what a note must contain to be valid. There are five certain parts of a note which must appear before a perfect instrument, valid at court, generally speaking, will be brought into existence. We list them as follows:¹ The instrument or note must: (1) be in writing, (2) must contain an unconditional promise, (3) must be signed by the maker, (4) must state payment to be made at a fixed or determinable time, and (5) must be for a sum certain. If you have any occasion to take a note from a customer, be sure that all these five conditions have been met.² Failure to meet all the requirements might *not* invalidate

the note, but it might also make it difficult to collect.

Let us see how this actually works out. Take the ordinary promissory note, for instance. How does it read? It says: "On demand" or "So-and-so many days after date" (Condition No. 4), "I promise" (Condition No. 2) "to pay," "So-and-Such number of dollars" (Condition No. 5) "to the order of Blank," and "For Value received." Then it is usually signed (Condition No. 3) and, of course, it is in writing (Condition No. 1). Thus does the ordinary note meet the original five requirements.

Sometimes a note is made payable to the maker himself (as in automobile accounts), then it must be signed on the back (indorsed) by the maker in order to make it good.³

Now, since a note must be "presented" in order to have it paid, and since it must be presented at a certain place, it is best to include the place of presentment on the face of the note. So we add the words, "At such-and-such a place or bank" after the words, "Such-and-such an amount of dollars."¹² If no place of presentment is mentioned on the face of the note then you will have to chase the maker to his home or office, and if he is not there, then to his last known address. This is very inconvenient, and so it is best to place the place of presentment on the face of the note itself.

Remember, this "presentment" is very important. You must exhibit the note in order to have it paid. It is a fair excuse not to pay the note if it is not surrendered at the time of offered payment. However, you need not present the note if you know: (a) the maker is dead, or (b) he has absconded, or (c) he is a fictitious person, or (d) when he has already told you that he will not make payment when the note is due.¹²

How about notes that are payable on demand? That means they must be presented within a reasonable time from the date on which they have been drawn. What is a reasonable time? That depends on the customs of the trade in which you and the maker of the note are engaged. It is longer for some businesses than others. In the radio service and sales business, where merchandise is sold "on time," and the seller (yourself) asks for a "demand note," almost any length of time will be absolutely O.K.¹⁰ In the final analysis, the question of time is one for the jury in court to determine.¹¹

So much for a brief résumé on notes. What about checks?

(Continued on page 45)

1. Dorsey v. Wolff, 142 Illinois 589.
2. Neyens v. Hossack, 142 Ill. App. 327.
3. Kayser v. Hall, 85 Illinois 511; Hoblit v. Sandmeyer, 166 Ill. App. 431.
4. Ill. Stat. Ann. Sec. 89.206.
5. Sublette Exch. Bank v. Fitzgerald, 168 Ill. App. 240.
6. Merchant's National Bank v. Ritzinger, 118 Illinois 484.
7. Ill. Stat. Ann. Sec. 89.207.
8. Simonoff v. Granite City National Bank, 202 Ill. App. 631.
9. Sehree v. Thomas, 166 Ill. App. 427.
10. Ill. Stat. Ann. Sec. 89.215.
11. Naule v. J. L. Hanson Co., 262 Ill. App. 160.
12. Ill. Stat. Ann. Sec. 89.170.
13. Fry v. Jenkins, 173 Ill. App. 486.
14. Keller v. Rock Island State Bank, 292 Illinois 553.
15. Reuter v. Dolph, 207 Ill. App. 54.
16. Sneed v. Sabinal Mining & Milling Co., 71 Federal 493.

Power Line Interference

by **WALTER E. KEEVER**

Detroit, Michigan

The power line serving the AC-DC set is a general cause of a lot of interference. The author describes how to eliminate this type of trouble.

PART II

MOST savage tribes have a theory that the best way to get rid of a pest is to eat it. In Part I last month we considered why and how to divorce the power line from its domination of the antenna circuit. That was presupposing a fairly good antenna and a reasonably short ground wire. Cliff dwellers, owners of a.c.-d.c. sets, and other unfortunates who are denied those luxuries, would have very little reception left if they locked the back door of the receiver.

The only sure way to cut an a.c.-d.c. set loose from the line is with an ax. One side is physically connected to all cathodes, to supply "B" negative. This common connection may be the chassis itself, or a bus wire connected to the metal case through a condenser. In the latter case you would be only slightly, not completely, killed when fondling the chassis with the power plug in. (Enclosed in a non-conductive cabinet, these sets are as safe as a telephone.) If you are familiar with radio circuits, full of bullish self-confidence, or don't care much for the set anyhow, you might try a one-quarter to one microfarad condenser across the line. It should have a rating of at least 400 volts, and must *not* be of the electrolytic type. First, *pull that plug*. One man used a capacity of six microfarads, and claimed it suppressed hum. No doubt it did. We hope he kept the power plug out when the receiver was not in use—enough a.c. to light a 30-watt lamp will pass through six microfarads.

When operating on a.c., it makes no difference which side of the line goes to the cathodes — it is bound to be negative half the time. The other side pulls on all plates, through the rectifier tube. Reverse current is prevented by the one-way action of the rectifier, so no 60-cycle can get through and burn out the electrolytic condensers in the "B" filter. But that small vacuum gap does not stop radio-frequency.

If really determined to cut off your line to spite your receiver, do it the safe way, with one of those \$2.35-to-\$4.41 inductive-capacitive plug-in line filters, described in Part I. Then no r.f. from the line can get in the back way. What! Not any? Well, hardly

any. But lo!—reception has dwindled to minus decibels. It may be possible to rig up an independent antenna circuit, at a price. Before going to that trouble and expense, it would seem wiser to make the most of existing conditions with a few simple alterations.

Figure 6 is a diagrammatic representation of the antenna circuit of an a.c.-d.c. receiver. This type is chosen as the horrible example of complete line domination. Only the bare essentials are indicated: at K, three cathodes, directly connected to the line; at P, three plates, connected to the other side of the line through rectifier tube K-P. Here, X marks the spot where a radio-frequency choke capable of carrying safely 100 milliamperes would do some good. Coils P and S are the primary and secondary of a radio-frequency transformer. Toothpick A, sticking out to the left at the top of antenna coil P, represents that flexible wire called the "antenna" by

courtesy. Draped around the picture molding, it helps to rationalize the ensemble, while the power cord substitutes for a ground wire.

At a rough estimate, 99 per cent of the radio-frequency pickup comes from the power line, of unguessed length, and grounded here and there along its farther reaches. Plate P of rectifier K-P is at high r.f. potential. Interference passing through K-P capacity into the plate circuits is suppressed by chokes and bypass condensers therein — we hope. A condenser across the line would tend to lower r.f. potentials at the rectifier, as previously hinted.

Usable r.f. aplenty comes up the other side of the line. If we cut off antenna A, the top ends of coils P and S form the extreme open end of the power-line "antenna." Every wave that washes up the coils breaks on the grid, and the receiver is un-tunable. So, that pitiful little antenna does serve a useful purpose. It relieves pressure on the coils and grid, the high r.f. voltage now appearing at the end of antenna A. Some *current* passes through primary P, permitting S to function as a tuned, coupled circuit. Interference that gets through into the plate circuit is further discriminated against by the tuned grid circuit of the detector. The "drag"—reflected resistance—of the power line broadens tuning, so these sets are not noted for selectivity. At least they

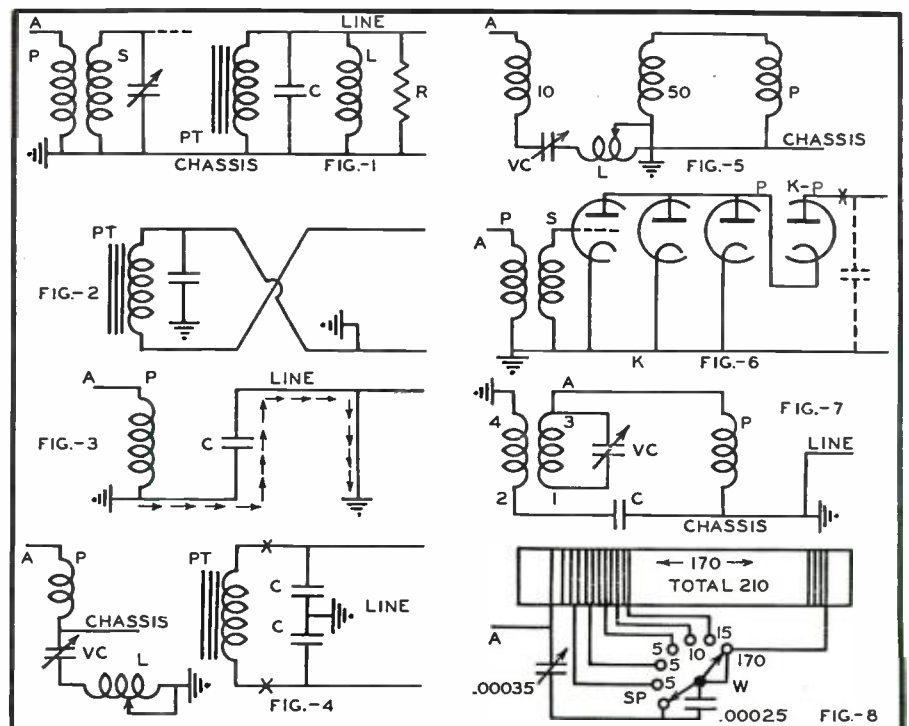

Various interference circuits described by the author.

will separate the locals, their main reliance.

If the capacity of that small "antenna" permits r.f. from the power line to oscillate through the antenna coil, why not ground that wire to the huge earth capacity and let it *all* go through? There is no knowing how many people blew out fuses, burned out antenna coils, or worse, because they neglected to connect a condenser in that down lead. The chassis may be on the "hot" side of the line—it depends on which way the power plug is inserted. Nevertheless, the idea is a good one, with one simple precaution. Insert a .01 mfd. (one-hundredth microfarad) condenser in that ground lead. It should have a rating of at least 400 volts. There may be one already, in the chassis, but do not depend upon it. This ground connection is neither an antenna nor an ordinary ground wire, but more of a "down spout" inducing the power line to drain off its radio-frequency through "antenna" coil P. The line still is the real antenna, and the receiver is near the "high" end, but there will be much more current now and less voltage—a real improvement. Length of the down lead is not so important, but its pickup is undesirable, coming from the noise zone. It would be better to replace the original flexible wire with a shielded ground wire, grounding the shield also at the lower end.

The same arrangement can be used to enable a straight a.c. receiver to make the most of power line pickup. In these receivers, distinguishable by the power transformer, there is no direct connection of the line to either the chassis or any radio circuit, so the protective condenser can be omitted from the ground lead with safety. Applied to a *Kennedy 64-B*, 10-tube all-wave superheterodyne, all wave lengths from 14 to 540 meters were received with good volume, and no more *outside* interference than with a noise-reducing antenna that could not be entirely removed from the noise zone. Short waves included European and South American. A vacuum cleaner operating in an adjoining room caused severe interference on distant stations, but little on locals, which do not require high sensitivity. The remedy, or palliative, is a plug-in filter attached to each such appliance to prevent its electrical disturbances from spreading through the house wires.

Grounding the antenna post increases sensitivity, or rather input, but not selectivity. A tuned antenna circuit is the ideal, as it stifles most interference before it can enter the receiver, and vastly increases *current* at the desired frequency. A power line "antenna," broken up into sections by grounds and pole transformers, would resonate to several different frequencies at any setting of the large variable condenser ordinarily used for antenna tuning. Further complications would arise from the ever-changing load of inductance, such as motors,

(Continued on page 47)

The VIDEO Reporter

by SAMUEL KAUFMAN

Hot Stuff!

TELEVISION has already reached the door-to-door selling stage in small towns and villages served by experimental video transmitters.

While on a week-end trip in upper New York State—about 100 miles from Manhattan—the Video Reporter had the opportunity of witnessing an attempted sale to the proprietor of a country hotel.

"You're way out of date if you don't have a television set this summer," the salesman said. "Your guests won't be content with ordinary radio programs any more."

"I'm not investing another cent in my place this year," the hotel owner said, hoping to cut the spiel short.

"But you can't get along without one," the salesman persisted. "Reception up here is excellent. It's a lot of bunk that the reception is limited to fifty miles from the city. Haven't you seen the demonstrations in town? And my set is even better than the line in town."

The salesman, it developed, hied to the country territory all the way from New York and didn't represent a local dealer. Rather, he was competing with the local stores which themselves were trying to push video sales in the area.

"I can give you a better break than any local dealer," he added. While he stressed the advantages of one particular line—and a secondary line at that—he implied that he could offer a better buy on any desired product.

He didn't carry any demonstration equipment but, instead, wanted to capitalize on any local demonstrations the prospect saw.

Here's a sales method that will have to be clamped down in all fairness to locality dealers. Footloose salesman do more harm than good and can upset the more constructive sales efforts of local dealers. Door-to-door salesmen may have their place in television just as they have in vacuum cleaners and other home appliances. But the door-to-door fields should be left to local dealers. It's seemingly unfair for a New York City retailer to canvas prospects 100 miles away when there are local stores after the same buyers.

Long Distance Reception

AN encouraging side to the above incident is the proof that New York's video transmissions are being received so well over the 100-mile span.

Telecasters no longer emphasize the point that the coverage area for sight-and-sound transmissions is limited to fifty miles. As a matter of fact, they make little mention of any limits at all.

And one reason is that they don't really know the limits. Their past statements on coverage were constantly disproved—but always in favor of greater service areas than the ones they estimated.

Perhaps, it's best to be conservative on coverage claims at this stage of the new art. Manufacturers feel that a single set sold that won't receive telecasts efficiently can harm the sales prospects in an entire community. And it's for that reason that they insist the dealer handle the installation rather than let the buyer attempt setting the set up himself.

Telly Price Slash?

THERE is talk in New York of an added slash in television set prices to offset adverse publicity created by the FCC's refusal to sanction commercial telecasts.

The second cut will bring retail prices down to almost ordinary receiver levels. But just how dealers will approve of this move is another story; many of them are a bit fed

up with the varying sales policies of television set makers and they will be especially concerned with a plan that may offset radio set sales without a subsequent replacement in desired television receiver sales.

The Road Back

TELEVISION is again a highlight at the New York World's Fair. Somehow, though, the demonstrations are not getting the enthusiastic word-of-mouth publicity that last year's demonstrations were accorded.

There are two suggested reasons for the lack of video enthusiasm. The more optimistic one is that television is no longer a novelty and is already in the progressive category of "an accepted thing." But the other reason—and one that cannot be ignored by the trade—is that the public is losing interest due to long delays in establishing satisfactory program services in various sections of the U.S.A.

Manufacturers are not kidding themselves about the fact that so many adverse things have happened to television in the past few months that it will take a considerable time to win back all of the video enthusiasts who have lost patience with the clashing views of manufacturers, not to mention the indecision of the FCC regarding the launching of commercial telecasts.

The 1940 World's Fair demonstrations closely parallel, the 1939 showings. This year there are three girls at the Fair sharing the title of "Miss Television." They are Patricia Fitzgerald, Starr Martin and Patricia Murray; the comely trio was selected

(Continued on page 52)

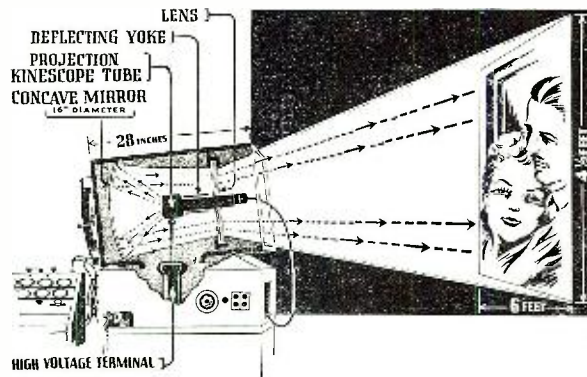

It's all done with mirrors, folks. The CR tube faces backwards, and the image is reflected through a lens to the large screen.

What's NEW in Radio

Radex Corporation, Chicago, Illinois, announces their new Shielded Align Loop Antenna which can be used in conjunction with any test oscillator or signal generator, to align loop antenna radio receivers. The unit is complete with dummy antenna and shielded generator leads, housed in an attractive chromium plated shield and black crackle finished base.

Radex Corporation has moved into new and larger quarters at 1733 N. Milwaukee Avenue, Chicago, Illinois.

National Recording Supply Co. has been formed at 1065 North Vine St., Hollywood, by Glenn Wallichs, who for years has conducted a Beverly Hills recording studio. Associated with him is F. H. Brown, the past several years sales manager of Radiotone, Inc., Hollywood manufacturer of recording equipment. The firm has been appointed exclusive Hollywood sales representatives for recorders and microphones of the **Universal Microphone Co.**, Inglewood, Cal. They will do a general retail business for recording machines and accessories.

Cutting Needle users are exercising more care in selection of these important items according to the **Recoton Corporation**, 178 Prince Street, New York City. This is a healthy aspect, they continue, and **Recoton Steel Cutting Needles** have always been built to stand such thorough inspection. They are made to keep their shape, stiff tool metal being used to obtain this hardness. This is vital, for the Needles, like a lathe's cutting tools cut their own shape into the record grooves. Special Swedish steel alloy retains the cutting edge for a longer time than heretofore possible. Diamond-dust polishing affords a smoother, more perfect cutting edge, resulting in a quiet, shiny groove. The Needles are furthermore individually inspected for flawless performance. To insure against the human angle affecting the cutting efficiency, each style **Recoton Steel Cutting Needle** has a flat on the shank making it impossible to insert it at a wrong angle.

The ultimate development in automotive radio aeri-als is **Radiart's** new **Ro-Tenna**, a new mechanical wind-up aerial, which is controlled entirely from inside the car. A handy knob raises or lowers the aerial to the exact height desired for peak reception or for clearing obstacles overhead.

Ro-Tenna is distinguished by its smooth, effortless operation. It works regardless of weather conditions.

It is furnished in several models, including a streamlined, modern side cowl mount, one model which attaches to the metal strip dividing the windshield, another fastening to the left windshield pillar and two types which extend vertically from the cowl, just in front of the windshield, one being concealed when not extended. The illustration shows Model CW-2, which is mounted on the left cowl and has a remote control wind-up knob on the instrument panel. A quick attaching clamp is provided, which permits one to fasten the control knob on the bottom edge of the instrument board, if you don't want to drill through the panel.

There is a **Ro-Tenna** to accommodate any installation condition, and all are very moderately priced.

After several years on the drafting board and in various stages of tests, **Ro-Tenna** has for some time been in service in the field and is proving its complete dependability under all conditions.

A timely unit of the new 1940 **Clarion** line of Sound Equipment in view of the forthcoming elections, is the just released Model CS-29, 19 watt Mobile Sound System.

Designed primarily for sound truck use where operation must be from the six volt battery



supply, the amplifier also is capable of operating from a 110 volt a.c. source to make its use possible under all circumstances and conserve the car battery whenever an a.c. line is available.

A new improved circuit utilizing 1—6J7, 1—6SC7, 1—6F8G, 2—6Y7G's and a 6W5G rectifier gives a rated output of 19 watts and a peak of 25 with frequency response within plus or

minus 3db from 50 to 10,000 cbs. Hum level below .006 watts—22 db. Microphone gain 110 db. Output impedances of 2, 4, 8, 16 and 500 ohms are available merely by changing position of the impedance selector.

The complete system consists of the amplifier with built-in record player, 2 heavy duty 12" P.M. speakers with 50 feet of cable and plugs, 2 aluminum dome baffles, high quality crystal microphone and stand. The system is completely wired and assembled and need only be plugged in to operate. List price complete, \$155.27.

For further information and catalog describing the entire **Clarion 1940** line, write to **Trans-former Corporation of America**, 69 Wooster St., New York City.

Universal Microphone Co., Inglewood, Cal., has brought out its 1941 "Amateur's Chest Mike" for amateurs, mobile transmitters, sound trucks and other uses. It can be adapted to a multiple of uses in cases where operators must have both hands free.

The "communications" type of crystal microphone is said to have excellent voice characteris-



tics. The hook, or semi-breast-plate arrangement, leaving both hands free, is chrome plated. Ten feet of rubber covered cable is included. Known as model N-3 [\$19.50] the new **Universal** catalog item is lightweight, rugged and compact. It weighs less than half a pound; and not quite two pounds when packed. Frequency response is 50-50,000 CPS and the output 48 db below one volt per bar.

The **Delur-Ansco Corporation** announces its entrance into the meter manufacturing field and is now in production on a complete line of **Delur** ammeters, milliammeters, microammeters and volt-meters in 2-inch, 3-inch and 4-inch sizes, round and square cases.

This line is primarily intended for manufacturers of radio, recorder, transmitter, service and

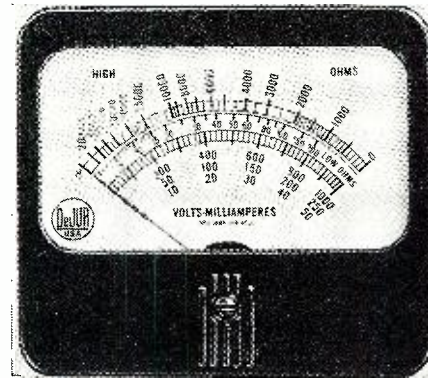

miscellaneous electrical equipment. Now one of the leading manufacturers of precision metering equipment for the photographic trade, and with an extensive plant established at Shelton, Connecticut, **Delur-Ansco** enters this new field with an enviable background of technical and manufacturing experience.

The new **Hammartund** "UHS-900" acorn tube socket contacts are silver plated Beryllium and are provided with grooves so that the tube snaps into place, permitting the socket to be mounted in any position. This new socket has a metal shield, which, when used with the pentode type acorn tube, completes the internal shielding of the tube and thus greatly reduces coupling between input and output circuits. Higher gain and greater stability are, therefore, obtainable.

The base is so designed that the contacts are locked in place and can not shift or get out of

alignment. This base is not ordinary **Isolantite**—it is made of super **Isolantite**, called "Iso-Q," providing exceptionally low losses with improved power factor.

The "UHS-900" has an overall base diameter of 1 1/16" with 1 1/16" mounting centers. This new socket is really a great improvement over sim-

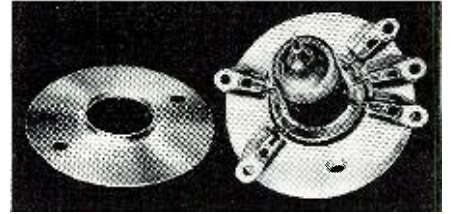

ilar types and will be extremely popular with users of ultra-high frequency equipment. Made by the **Hammartund Manufacturing Co., Inc.**

A new A-B power supply that operates on any 6-volt d-c power source is announced by **Electro Products Laboratories**, 549 W. Randolph Street, Chicago.

This **Synchro Model Q** operates any 1 1/2-volt radio having 4, 5, or 6 tubes and its compact design recommends it for use with portables as well as farm sets. It measures 5 1/2" x 5" x 2 3/4". Weight 3 1/2 lbs. Separate plug-in sockets provide correct filament voltages for 4, 5, or 6-tube receivers. 90 Volts B at 18 milliamperes are obtained through a synchronous vibrator system.

Efficient circuits of the Model Q make for economical operation. It will operate any 4-tube set a month (average 4 hours per day) on a single charge of the storage battery—40 hours on a "Hot Shot" 6-volt dry battery. (Battery drain 0.75 amperes.)

The **Synchro** makes it easy to operate a portable from the automobile storage battery. Ideal for use in trailers, by campers, or with any farm set.

A similar unit, the **Synchro Model R**, is available for 4, 5, 6, and 7-tube, 2-volt radio receivers supplying 67, 90, 112, and 135 volts B at 20 ma.

Completing the new G-E line of small sets is the model JA-64 superheterodyne automobile radio, incorporating the feature of touch-tuning for safer driving and more convenient operation. Eyes can remain concentrated on the road while stations are tuned in automatically at the touch of a key. New stations can be set up easily. The radio comes complete with distributor suppressor, generator capacitor, and mounting bolts. A single row of five touch-tuning buttons is located on the front of the receiver below the dial scale. The method of setting-up new stations has been considerably simplified. The button to be set up is grasped and turned once



completely to the left. The station desired is then tuned in by hand, the button pushed in, turned to the right and tightened.

The automobile set has a manual tuning knob in line with the dial scale, an illuminated slide rule dial, and a 6-inch built-in electrodynamic speaker. Chassis and speaker are built into a single unit which mounts under the instrument panel. A variable antenna adjustment is provided to match the receiver's circuit with the antenna installed in the car. The receiver incorporates the latest circuit design for eliminating interference noises which may enter the receiver by means of the battery leads. The set uses six pre-tested G-E tubes, and has a battery drain of 7.3 amperes. The case is finished in gray wrinkle enamel. **General Electric Co.**, 570 Lexington Ave., N. Y. C.

Sun Radio Company, 212 Fulton Street, New York City, announces the expansion of their public address department. As engineer-in-charge they have appointed John M. Heddaeus, who comes to **Sun** with a background that includes Federated Purchaser, Inc., Webster Electric Co., and Allied Radio Corp.

Featured amongst the many new models on display is a **Mercury Portable 14 watt Amplifier System** in one carrying case, consisting of high-gain amplifier with built-in phonograph motor, turn table and pick-up, 2—10" Dynamic Speak-

ers, 50 feet cable and desk mount crystal microphone and cable. (Also available with two walnut speaker baffles instead of portable case for semi-permanent or permanent mounting.)

Ideal for churches, schools, auditoriums, or-

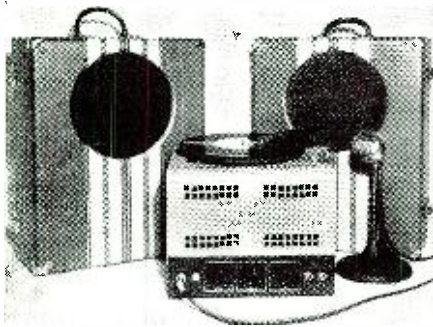

chestras, club meetings and groups approximating 1500 people. Outdoor coverage over 4,000 square feet. Price, complete, is only \$49.00—net.

The *Browning Laboratories*, Winchester, Mass., has announced an extremely compact 5-10 meter converter for receiving two bands of frequencies, when used in conjunction with any mobile, home, or aviation receiver. The receiver to which the converter is attached acts as an IF amplifier as well as supplying plate and filament voltage for the 6X8 tube used in the converter. Four separate low loss tuned circuits are employed resulting in exceptional performance. Isolantite insulation is employed on all tuning and trimmer condensers.

The BL-510 is described in detail in bulletin 106 available from jobbers or directly from the *Browning Laboratories*.

Westinghouse Electric Supply Co., 150 Varick St., N. Y. C., announce the WR-186. This two band AC-DC Superheterodyne receiver notable for high sensitivity and original cabinet treatment features—foreign short wave and domestic broadcast bands—automatic volume control—5" permanent magnet dynamic dustproof speaker—5½ to 1 ratio vernier drive—illuminated sliderule dial—6 mechanical buttons with downward push—beam power output—two position tone control—built-in loop antenna—terminal board for phonograph connection and terminals for auxiliary antenna.

Frequency range—540 kc. to 1600 kc. 6000 kc. to 18000 kc. Power supply—105-125 volts,

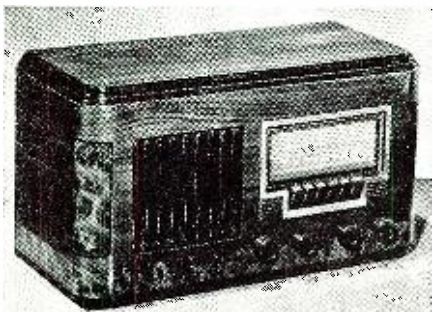

50-60 cycle a.c. or d.c. current. Listed by Underwriters' Laboratories, Inc.

Cabinet—Beautifully finished and hand-rubbed, this walnut cabinet achieves new heights of distinction through the decorative treatment of the corner panels and bottom stripe. New-style knobs match moulded type walnut louvres which feature the grille. The 6 push buttons are easy to read and operate at a touch. The burnished line of the escutcheon frames a darker brown band which matches the decorative squares flanking the buttons. Behind a glass panel on which ivory figures show, the white pointer moves across a dark gray background brightened by red letters and gold lines.

The new *Electro-Voice* "605" Dynamic microphone is totally new in design . . . setting a new standard of value in the low priced field.

Aluminum voice coil, polystyrene insulated . . . Zamak 3 castings . . . Durev diaphragm . . . Armo magnetic iron; magnetic circuit . . . large Alnico magnet . . . ¾-27 stand coupling . . . Weight 15 ounces.

Frequency response: 45-8,000 c.p.s.
Output:—57 DB.
Impedances available: Hi-Z (Direct to grid) 50,200, and 500 ohm.

Cable capacity per foot: .000025 mfd.
Available in dark gunmetal and bright chromium finishes.

Electro-Voice Manufacturing Company, Inc., 1239 South Bend Avenue, South Bend, Indiana.

The latest addition to the *Precision* line of test equipment is the new Series 832, a 31 Range, Rotary Selective A.C.-D.C. Multi-Range Tester. The 3½ inch meter is the largest ever incorporated in small, popular priced multi-range testers. 6 d.c. voltage ranges at 1000

ohms per volt up to 1200 volts; 6 a.c. ranges at 500 ohms up to 2400 volts; 4 d.c. current ranges to 1200 milliamperes; 3 ohmmeter ranges to 5 megs. (to 500 M ohms on internal 3 volt battery); 6 decibel ranges (—10 to +62); 6 output ranges to 2400 volts. In walnut finished hardwood case with self contained batteries. Size 7x4½x3 inches.

Precision Apparatus Company, 647 Kent Avenue, Brooklyn, New York.

Anticipating the early widespread use of FM receivers, the new *Taco Master Antenna System* just announced provides for an expanded frequency range to include FM reception. The great gain in performance of this group antenna is made possible by the use of special high-frequency iron-dust cores, permitting full isolation of primary and secondary transformer windings without any loss in signal strength. By the special design and spacing of the windings, it is now possible effectively to block any line noises from passing from the set into the transmission line which feeds other sets as well in the apartment house, hotel or other multi-set building. This feature is most important in raising the signal-to-noise ratio of the entire system. It makes quiet reception possible in locations where, in the past, nothing but clicks and buzzes could be heard.

As a further contribution to efficiency in this noise-reducing antenna system, the master roof

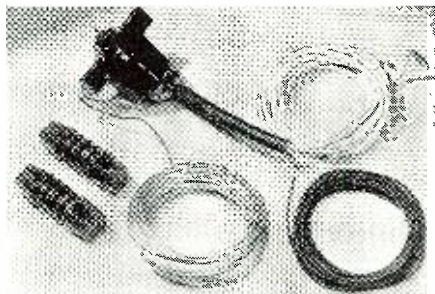

unit has been changed over from the unbalanced doublet to an L-type aerial. The number of set couplers fed by one master antenna remains the same as before, 15 to 25, depending on the height of the aerial and reception conditions.

Technical Appliance Corp., 17 E. 16th St., New York City, also announces the revamping of its home antenna system kits, using powered iron core transformers in extending the operating frequency range to cover from 150 kc. to 75 mc.

One of the serviceman's greatest problems is the maintenance of adequate stocks of replacement parts without running up his inventory to prohibitive levels. In many instances the speedy delivery service offered by local supply houses helps in the solution of this problem but for small items needed in a hurry the cost of a telephone call and perhaps postage plus delay may largely offset the profit margin.

In the matter of capacitors the *Cornell-Dubilier* Type BZ tubular electrolytics go a long way toward enabling servicemen to carry adequate replacement stocks with minimum investment. Not only are these capacitors now available in almost unlimited variety of capacity and voltage values, but provide a universal mounting feature which permits either upright or horizontal mounting, above or below the chassis.

These moisture-proof cardboard encased units are supplied with both straps and upright mounting feet which can be adapted for spade-bolt mounting if desired and with 6" wire leads. They are available in single, dual, triple and quadruple combinations. Common negative or separate sections are available in the multiple units. In the single units capacities range

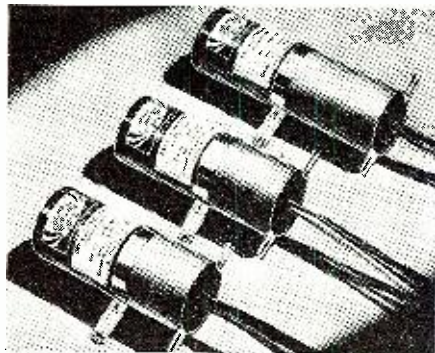

from 8 to 24 mfd. at voltages of 250 to 450 and in the dual units from 8-8 to 16-16 mfd. at these same voltages. Most of the triple and quadruple units include low-voltage, high-capacity sections as well as the high voltage sections, all grouped in the most practical combinations for nidget and standard receiver replacement work where voltages run from 150 to 450 and capacity requirements up to 40 mfd. per high-voltage section.

Cornell-Dubilier Electric Corp., South Plainfield, N. J.

Utah Radio Products Company of Chicago announces a considerably augmented speaker line. The new *Utah Baffle Reproducer* for public address systems, schools, colleges, taverns, dance halls, auditoriums, clubs, etc., in four (4) models is announced by the company to range in list price from \$29.50 to \$59.50, with the following features:

Total absence of "Back Radiation"—
Greatly improved distortionless bass response

Extra heavy, sturdily constructed cabinet, scientifically designed to eliminate cabinet vibration and resonance—

Especially adaptable for use with television and frequency modulation (FM) receivers which require a wide audio frequency range—

Frequency response up to approximately 9500 cycles per second—

Modern cabinet design—
Durable satin bronze finish.

In addition to the above *Utah* announces a new Bi-Directional Speaker and a new Wall Reproducer. The Bi-Directional Speaker was especially designed and engineered for factory call systems and paging systems at a popular price, with the following features:

Moulded non-metallic baffles—
No excessive low frequency response to "blur" intelligibility—

Swivel joint bracket for easy and correct mounting—

The new *Utah Wall Reproducer* was especially designed for all sound systems requiring a reproducer for music as well as voice, also at a popular price, with the following features:

Moulded non-metallic housing for improved tone quality—

Scientifically engineered angle for ideal coverage of a given area—

Especially designed angle bracket for single screw mounting.

In addition to the above interesting new products, the company announces three (3) new speakers especially engineered for frequency modulation in 8", 10", and 12" sizes, as well as two (2) new high fidelity perma-dynamic speakers using 15 and 23 pound magnets in the 15" size.

Utah Radio Products Co., 820 Orleans St., Chicago, Ill.

Hallcrafters, in their new HT-9 "ham" transmitter provide a striking example of highly refined design and sturdy construction combined with price economy made possible by the growing demand for ready-built transmitting equipment.

Five band-switched channels are provided for operation on any frequencies in any bands between 1.7 and 30 megacycles. These channels are set-up by means of plug-in coil units, each of which contains its own tuning capacity and is pre-tuned to the desired frequency on installation.

Rated carrier power is 100 watts on c. w., 75

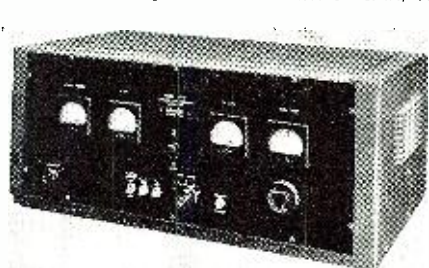

watts fully modulated on phone. The r.f. line-up consists of a 6F6 oscillator, 6L6 doubler and 814 power amplifier with automatic provision for using the 6L6 as oscillator when working straight through on the crystal frequency. The audio end employs a 6J7 input amplifier, 6J5 voltage amplifier and push-pull parallel 6L6's coupled to the 814 through a special 3-winding transformer for properly proportioned simultaneous modulation of screen and plate. Four built-in power supplies provide separate supply sources for the r.f. exciter, r.f. final, audio voltage amplifiers and 6L6 screens, and plates of the 6L6 modulators.

Three meters provide a continuous check on all circuits. Because all exciter circuits are pre-tuned, the only tuning control on the front panel is that for the r.f. final tank. Other controls are the audio gain and switches for standby, plate power, filament power, band-changing, meter shift and c. w.-phone. The HT-9 is completely self-contained in a 28"x18½"x11½" steel cabinet with interlock safety switch on cover. Neatly screened openings in ends and covers provide ample ventilation.

The Lear Aviation, Inc., Roosevelt Field, Mineola, L. I., N. Y., present the LEARADIO AUTOMATIC ANTENNA REEL which may be located in any part of the plane and operated by remote control from a small panel. Regulation of the antenna length may be accomplished in any of three ways: by turning the switch to the "Out" indication and permitting the aerial to unreeel the correct distance as shown by the tuning meter on the transmitter . . . by switching to "Out" and using the mechanical counter to determine the exact length of antenna released . . . by switching to "Out" and permitting the aerial to unreeel automatically to any of ten different and predetermined lengths selected by an indicator on the panel. In each case, a red warning light flashes the instant the reel is set in motion and

remains on until the wire is returned to its housing. To bring the wire back, all that is necessary is a flip of the switch to the "In" position which automatically reverses the motor. There are three built-in controls that exercise a check-function on these operations. When the antenna is not in use it is stripped under spring tension and cannot be freed by shocks or jars. When the antenna is lowered, its fixed end is anchored to the reel by an automatic lock which prevents stripping off. And if the aerial should not pay out for any reason, a third control prevents the wire from running loose and tangling in the airplane structure.

The LEARADIO AUTOMATIC ANTENNA REEL is not only mechanically fool-proof but it may be adjusted to eliminate the possibility of the pilot ignoring the warning light and forgetting to reel in. Automatic retraction can be accomplished by linking the unit to the air-speed, landing gear or flaps. The landing maneuvers will automatically set the reel mechanism in operation and return the antenna to its housing even if the switch is not thrown to the "In" position.

The unit consists of four parts: motor, clutch, aluminum housing (gears, gear arrangement, switch) and antenna reel. The motor can withstand temperature extremes of from minus 40 degrees F. to plus 150 degrees F. An electromagnetic clutch between motor and drive mechanism prevents coasting and assures reel braking at desired antenna length. All gears and shafts are of stainless steel.

A New All-Purpose Projector with an Entirely new Principle is announced by T. A. White, Jensen Sales Manager, known as the new SPH-8 Projector. It employs an especially designed Permanent Magnet loud speaker sealed into an enclosure. The air stiffness within the enclosure is exactly suited to the radiator and is used in the design.

The result is a sharp improvement in the middle frequency response and in that quality of crispness and intelligibility so essential to the re-



production of sound in public address applications. In addition, the entire lack of radiation from the back of the Projector is of great advantage in eliminating feedback trouble.

It is weather-proof, easily handles 25 watts, and electrical access is gained by a strong bayonet type separate plug and socket assembly. Sells complete with PM speaker and swivel mounting stand for \$34.20 net. Jensen Radio Mfg. Co., 6601 South Laramie Avenue, Chicago.

RCA Manufacturing Company, Inc., Harrison, New Jersey, is making available through their transmitting-tube distributors a new Iconoscope designed for amateur and experimental use.

This new Iconoscope designated as the RCA-1547 makes it possible for the first time for the amateur to construct at a cost within the range of amateur transmitters a complete television system operating on electronic principles. It also makes practical the construction of equipment by many more schools for demonstrating to students the principles of electronic television utilizing actual pickup.

The 1547 can provide a clear 120-line, 30-frame-per-second picture suitable for transmission in the 2 1/2- or 1 1/4-meter amateur band. It

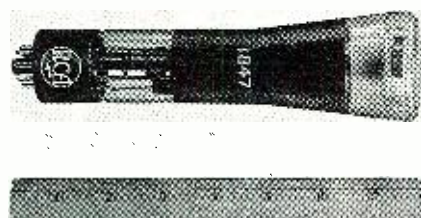

operates at relatively low voltage, employs inexpensive electrostatic-deflection circuits, does not require keystone correcting circuits, and can utilize low-cost, short-focal-length lenses.

The equipment required for the operation of an amateur television system includes a camera

and monitor unit, an ultra-high-frequency transmitter, and a receiver. Such equipment has been built in our laboratory by our engineers and is described by them in a series of articles appearing in the publication QST. Standard components used in broadcast receivers have been used almost exclusively in these circuits.

The pioneering amateur will welcome the advent of the 1547 since it will enable him to apply his ingenuity to the vast and intriguing field of amateur television. He will gain new experience in the application of circuits as well as of lighting, photographic, and optical principles; and at the same time, he will contribute to the development of a new art.

A new low-voltage Tattlette ("It-Tells-The-Tale") pocket tester has been designed by Littelfuse to cover the range from 3 to 25 volts, momentary up to 50 volts, a.c. or d.c. It uses a high temperature coefficient lamp to cover this relatively wide range of voltage.

The lamp is housed in a molded, transparent tennite case. It has tinsel wire leads, and alli-

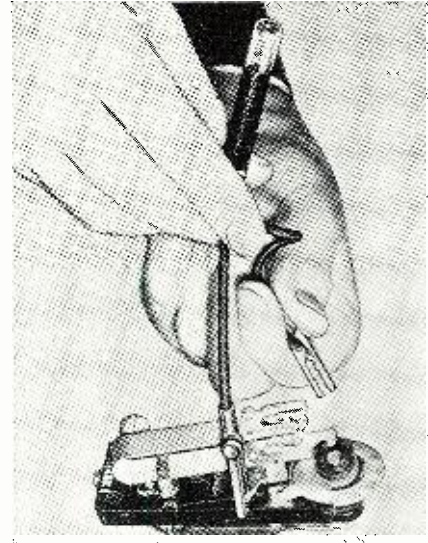

gator clips. Draws only 70 mils. @ 12 volts.

While it was designed primarily for use on the 24 volt control systems in Heating and Air Conditioning, the largest field is Circuit Checking in automobiles, trucks and buses, airplanes, telephones, boats, radio, bells, buzzers, storage battery circuits, etc. This unit is manufactured by Littelfuse, Inc., Chicago, Illinois.

Representing one of the most important basic improvements in loudspeaker design in a number of years, a new type of "accordion edge" loudspeaker has been perfected by the RCA Manufacturing Company to reproduce low frequencies with a fidelity never before possible with a small speaker in a small cabinet. Although only 7 inches in diameter, the new instrument has a frequency response of from 80 to 7,000 cycles.

The new loudspeaker makes effective use of a folded or "accordion edge" cone support principle which permits the cone to move more freely when driven by the permanent magnet speaker mechanism. The cone was developed by Dr. H. F. Olsen in the RCA Radio Research Laboratories at Camden.

"The new loudspeaker opens up many possi-

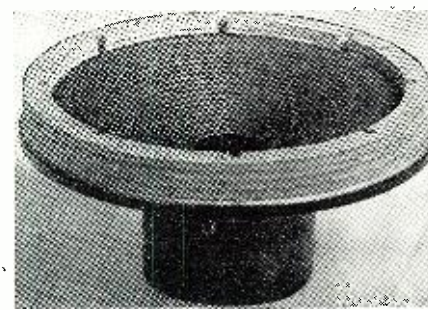

bilities," George Ewald, Manager of the Commercial Sound Division, said. "It is certain to establish new standards of performance hitherto deemed impossible with a single small speaker. Schools, churches, hotels, clubs, and other places which require small but high quality loudspeakers will find this new instrument meets a long felt need."

Designated as Model MI-6233, the loudspeaker includes an attractive walnut wall housing with sloping baffle. The speaker mechanism is also available separately. It measures 7" in diameter, 4" deep, and weighs 3 pounds.

The new "accordion" support increases the lower reproducing range of the speaker cone by at least one octave, and is extremely simple in design and construction. Over-all frequency re-

sponse is very smooth, and requires less power. Permanent field excitation requires no power supply. Power handling capacity is three watts continuously.

National Union announces a deal on a new Model 633 Battery Tester made by the Triumph Manufacturing Company of Chicago.

This tester is a direct tester with a switch setting proper voltages for battery testing and a meter showing percentage of useful life.

It is finished in an attractive two-tone brown with red switching knob. This battery tester

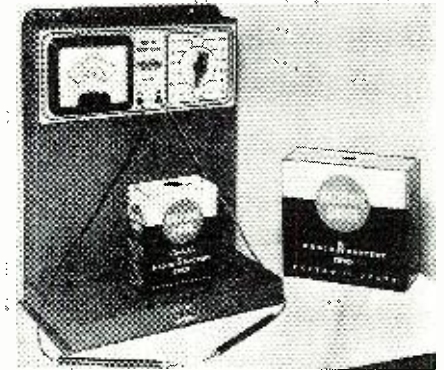

can be used on the dealer's counter or secured to his panel as the shelf forms a support for batteries while being tested. By using this tester, the dealer can actually show to his customers what the condition of the battery is.

Full information regarding the details of the deal on this tester are available directly from National Union Radio Corporation, 57 State Street, Newark, N. J.

A new test oscillator which inherits all the exclusive features of a famed predecessor while adding several new features of its own, has been announced by the RCA Manufacturing Company.

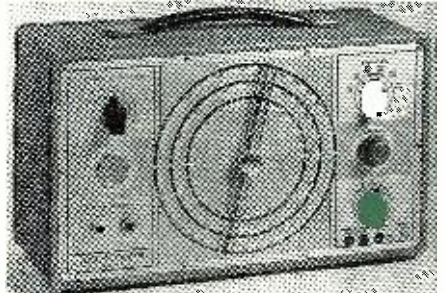

Designated as Stock No. 167, the new oscillator is an advanced model of the earlier 153 RCA Oscillator, with the addition of an output cable and a new type pointer. The panel has been completely restyled.

Creating an artificial signal which it forces through a misaligned radio receiver for alignment purposes, the test oscillator is an invaluable aid to service work. The No. 167, with its high R-F output (1 volt), is essential for locating trouble in an inoperative or completely misaligned set or for single stage alignment work.

The No. 167 is designed to meet every requirement for servicing the most complicated radio receiver. Its fundamental frequency range is adequate (100 to 30,000 kc.), and the dial scale is accurate and easily read (6 1/4 inches in diameter, 50" in length). In addition, it is so designed that external frequency modulation may be added for the oscillographic method of servicing.

The instrument has a 400 cycle output of 8 volts for audio circuit testing. Other features: six bands, minimum signal 2 microvolts, negligible leakage. Its sturdy cabinet is finished in blue-gray wrinkle lacquer, with panel finished in brush and bright chrome. Weighing 12 1/2 lb., it measures 13 1/4" wide, 9 1/4" high and 6 1/2" deep.

Of truly enormous significance to designer, manufacturer, serviceman and operator of radio and electronic equipment is the perfected plug-in electrolytic condenser now made generally available by Aerovox Corporation of New Bedford, Mass. Handling with the ease and speed of radio tube or vibrator changes, the plug-in feature permits an electrolytic condenser to be instantly removed without tools or trouble, for testing and replacement.

Developed primarily for the U. S. Signal Corps, the plug-in electrolytic has offered very obvious advantages to aircraft, police-radio and sound-system equipment where continuity of service is of paramount importance; and now, with its transition from custom-built item to standard condenser, the plug-in type can provide many new and startling possibilities in home and auto radios as well. Aerovox is now tooling up for the mass production of this type, bring-

(Next right hand column, please)

ing the cost down to the level of conventional electrolytics.

With the plug-in type, condenser tests and replacements can be made with minimum time out. Such electrolytics can be plugged into the assembly at any time and especially just prior to shipment or actual use; moreover, spares can be on hand for instant replacement and to keep equipment up to top efficiency even after years of constant service.

It required more than just the addition of an octal base to a metal-can electrolytic to produce this perfected, practical plug-in condenser. *Aerovac* had to solve numerous troublesome problems such as a true hermetic sealing of the unit, the absolute elimination of leakage or seepage of the electrolyte, and the prevention of internal or external corrosion due to joining dissimilar metals. A special octal base, however, fitting the standard octal socket, had to be developed and is now made in the *Aerovac* molding department. This special base has nickel-plated brass prongs engaging with similar socket contacts, for perfect, non-corrosive connections. These prongs join with aluminum studs, the junction being imbedded in the molded bakelite plug and fully protected against corrosive influences. The hi-purity aluminum tabs from the condenser section are placed in the cylindrical recess of corresponding aluminum studs the wall of which is sheared and collapsed firmly on the imbedded tab for a permanent, tight, low-resistance, corrosion-proof, aluminum-to-aluminum bonded connection. Thus all external metal parts are nickel-plated brass, all internal parts aluminum.

The electrolytic section is hermetically sealed in the aluminum can. The can top is spun over on the soft rubber gasket ring around the bakelite base. A vent in the cover allows slow escape of gas or immediate relief of abnormal pressures.

A new 8 to 10 watt amplifier designed especially to meet modern public address requirements has been announced by the *Terminal Radio Corporation* of New York City. The excellent frequency response of *Terminal's* new amplifier pictured here, permits this amplifier to be used in homes with good record players and frequency modulation tuners. Its audio power capabilities provides amplification for audiences of up to 500 persons indoors or outdoors coverage of up to 3000 square feet.

The *Terminal T-8* amplifier has two high impedance input channels for microphone and record player, with complete mixing and "fading"



features of higher priced amplifiers. Because of its compactness, eye-appeal and exceptionally low price (\$13.50, less tubes), the *Terminal T-8* amplifier is proving itself a profitable P.A. investment.

Frequency range is 40 to 10,000 c.p.s., plus or minus 2db. At 8 watts output, distortion is less than 5% — at 10 watts output, distortion does not exceed 7%. A special inverse feedback circuit is used. A tapped output transformer provides desired voice coil and line impedance of 2, 4, 6, 8, 16, and 500 ohms. The *Terminal T-8* amplifier is licensed by *Electrical Research Products, Inc.*, under patents of *American Telephone and Telegraph Company* and *Western Electric, Inc.*

Two distinctly modern marine radio telephones are now available to disseminating boatmen demanding reliable communication to and from their boat by *Transmarine Radio Inc.*, Hewlett, L. I., N. Y.

Both units, rated at 15 watts, are extremely low priced.

Many outstanding circuit refinements greatly improve operation, leaving nothing further to be desired by the boat owner. A few of these features include a *Static Mute* for reducing objectionable noise between calls; a *Battery Econo-mizer*, conserving power; an *Electrolysis Eliminator* which protects underwater fittings; and an improved antenna-coupler, increasing efficiency. These and others are exclusive *SHI-PHONE* features.

The *DeLuxe* model provides 3 channels automatically selected by a telephone-type dial. No tuning whatsoever is required, all circuits are pre-set.

A sensitive handset, with built-in push button, permits remote operation from any point on the boat. For private conversation, a switch cuts off the loudspeaker and substitutes the handset earpiece.

Extreme compactness is evidenced by the small

(Continued on page 57)

FOR IMMEDIATE RELEASE...

Hot & Spot News will be found in this column every month. Don't fail to read it!

Frequency Modulation Boon to Emergency Communication Service

BECAUSE one of the big troubles of present emergency services is interference from almost every conceivable source—static, ignition noises, street cars, extreme shadow effects, and other electrical interference—the advent of frequency modulation is being widely welcomed as a major development in the emergency service field." So stated E. E. Williams, *General Electric* radio expert of Schenectady, recently before a joint meeting of the Electronic Division of the *A.I.E.E.* and the *I.R.E.* at Seattle, Washington.

"FM eliminates, almost completely, man-made and natural interference. Recent tests showed that mobile transmissions are 100 per cent readable at a distance of 18 miles, even in the hustle and bustle of downtown New York where busy skyscrapers tower over the streets," Mr. Williams continued. "Better coverage of the service area is given. In some cases FM can be expected to almost double this area."

Synchronized FM

SYNCHRONIZED frequency-modulation" is the term selected by *Western Electric Company* to describe its new line of FM transmitters, the first unit of which was announced to the trade this week. Synchronized frequency-modulation is a radio wave generating system, developed by *Bell Telephone Laboratories*, in which the average or carrier frequency of the FM carrier wave is locked in step with the vibrations of a precision quartz oscillator. The carrier drift is thus confined to extremely close limits, an achievement which removes one of the final obstacles to FM broadcasting as a commercial reality.

According to F. R. Lack, manager of the Company's Specialty Products Division, the new line of transmitters exhibits a carrier stability matching that of the best amplitude-modulated units currently in use on the longer broadcast wave lengths. Mr. Lack calls attention to the importance of carrier stability as a factor in high-quality transmission and reception and pointed out that the newly-developed system limits carrier drift to within .0025 percent—at least four times better than the present requirement of the Federal Communications Commission of .01 percent.

Way Paved for More Television Stations

FULL commercialization of television was today promised by the *Federal Communications Commission* as soon as the engineering opinion of the industry is prepared to approve any one of the present competing television systems. Accordingly, the Commission will promptly license applicants to "provide further experiments on the different systems on a comparative basis."

Additional cities under consideration by the Commission for television facilities include San Francisco, Los Angeles, Chicago, Washington, Albany, Cincinnati, and Boston.

"There is no room for squatters" in the public domain occupied by television, says the Commission in announcing that these experimental stations will be apportioned among various parts of the country with the view of forestalling any concentration of facilities in particular centers of population to the exclusion of the rest of the country. To further prevent monopoly and promote free competition, there will be strict limitation on the number of stations authorized to any one licensee.

The Commission expects the industry to "insist upon such standards as will give definite assurance of satisfactory performance and continuity of service for the public comparable to the continuity of service displayed in the past history of the radio industry."

"It is essential to the progress of television," continues the report, "that there not be a mere semblance of competition, but that there be a genuine and healthy competition within an unfettered industry. The American system of broadcasting has been established by the Congress on a competitive basis. Television will be an important part of that system."

"Contrary to the experience of other industries which have found that technical improvements were stimulated by large public use," continues the report, "in the television field a major portion of the industry takes the view that successful promotional activities at this time can act only as an anchor on experimental efforts to go forward." Premature crystallization of standards, it adds, will "remove the incentive for technical research toward higher levels of efficiency."

"It is obvious," comments the Commission, "that the industry as a whole does not share the *RCA* view of forging ahead regardless of the untested possibility of improvements on the horizon. It further appears that the industry was not prepared to accept Sarnoff's promise of 'We live on obsolescence' as a basis for justifying a heavy public investment at current levels of efficiency."

Widespread public distribution of sets of a system operating on present levels, the Commission holds, will undermine incentive for further advance in television broadcasting and make frozen television standards an accomplished fact. Under present conditions television transmission will satisfactorily serve only sets designed to receive the number of lines and frames and the type of synchronizing pulse transmitted. Due to this "lock-and-key" relationship of the television transmitter and receiver, substantial changes cannot be brought about once widespread distribution of receivers operating on a particular combination of these factors has locked the system to that level.

Zenith's McDonald on Frequency Modulation

WE do not believe FM broadcasting and the type of receiver it demands will ultimately displace all other types. There are several reasons for this. Audio systems and loudspeakers that are capable of reproducing 15,000 cycle high fidelity are necessarily more costly than systems and speakers that will reproduce only 6,000 cycles. Where there is a special reason for receiving such programs the additional cost will be gladly borne but there are many uses for broadcast receivers that do not require such high fidelity. The very existence of such a demand will justify broadcasting in the bands we know today even if they are not modified. It is well known that today's high power stations give very satisfactory night time service in the area adjacent to their stations and also reach out for greater distances beyond what can be expected of frequency modulation.

If the change-over of smaller stations to frequency modulation should relieve the congestion of stations in the present amplitude modulation band we are confident that the present band itself can be revised to give 20,000 or 30,000 cycle separation between stations upon it and that a measure of high fidelity will be possible on the standard broadcast band which is not permitted today by the congestion. As frequency modulation improves, amplitude modulation will also improve and with its long distance ability will still have an important place in American radio.

The new market to be opened up is not a replacement market but a *plus* market. Just as the first drive of manufacturers was to get one radio for every home and a more recent drive has been to place additional sets in every home, frequency modulation will be basically a drive on the family living room where every home, regardless of what other sets it has, should have a high fidelity instrument for special broadcasts. We are planning a program in line with this thinking. The average customer will recognize the difference in reception of FM broadcasting and amplitude modulation broadcasting and a great many consumers will appreciate the difference.

Zenith will include FM receivers in the 1941 radio line at such time as current laboratory models can be adjusted to the standards recently announced by the Federal Communications Commission which are expected to go into full effect on January 1st, 1941. It is impossible at this time to determine the final characteristics of such units

(Continued on page 55)

TECHNICAL BOOK & BULLETIN REVIEW

FM AN INTRODUCTION TO FREQUENCY MODULATION, by John F. Rider, published by John F. Rider Publisher, Inc., 404 Fourth Ave., N. Y. C. 136 pp. Price \$1.00. The twenty years of radio broadcasting have seen revolutionary developments in all phases of the industry, but undoubtedly the introduction of frequency modulation to the listening public is one of the most radical of all. And there seems to be no doubt that it will be enthusiastically received for it has enormous possibilities.

This book is an introduction to frequency modulation with special attention given to FM receivers and the general maintenance problems with which the serviceman will doubtless be confronted in the very near future. No attempt has been made to give a complete explanation of FM transmission inasmuch as it was felt that the main facts about these FM signals and their difference from AM signals were sufficient to give the serviceman an insight to the character of the transmission.

It should be borne in mind that frequency - modulation, commercially speaking, is young and that great changes can be expected; hence this book should be considered as an introduction to the subject. Nevertheless it will be found that herein have been included those facts which the serviceman should know in order that he can do an intelligent job on FM receivers. Until recently, all commercial broadcast stations, irrespective of their operating frequencies, employed what is known as amplitude-modulated waves for the transmission of their programs; and as is to be expected all the receivers intended for the reception of these programs were designed to derive the proper intelligence from such amplitude - modulated waves. The past few months, however, have witnessed a great deal of agitation about a new form of transmission and reception, known as frequency-modulation. This is the brain child of Major E. H. Armstrong.

The subject of frequency-modulation involves some contradictions of existing practices and in general introduces new thoughts in connection with the operation of radio communication systems, transmitters and receivers alike. This book discusses some of these new ideas from an elementary viewpoint; with sufficient detail to enable a serviceman to speak intelligently when asked questions, which no doubt will be numerous in the near future, and to be able to service a receiver brought into his shop.

The material contained in the service chapter is the result of actual experimental work and also includes data gathered from whatever avail-

(Continued on page 53)

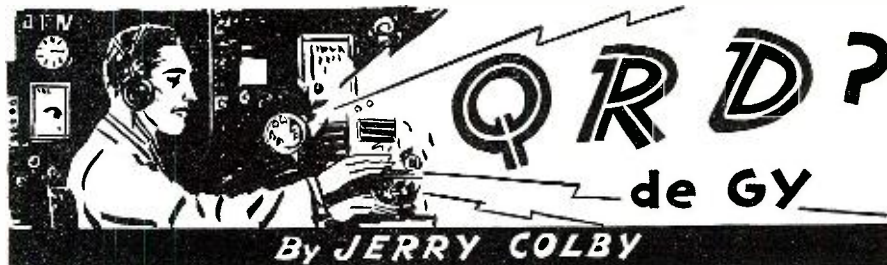

IN the June issue we subtly took a poke at one of our readers who had insisted that our enthusiasm about openings in the aeronautical radioping field was a trifle warped, even cock-eyed, he contended. So when we referred him to another one of our readers (ohyez, we have two) who was able to connect up muy pronto, he shot this epistle right back at us. . . . "Well, GY, my face is very red and it isn't this Florida sunshine. . . . I've landed a job down here with Pan American as radio maintenance mechanic despite the fact that I am over the age limit by five years. Being right on the spot here I can verify the statements you've made that the airlines are taking on men every week. I am happy to confirm your statements and I would like to tell any of the boys who might be getting discouraged as I was to keep plugging. . . . Incidentally, I know of a case where an airline op was given an undesirable assignment, quit on Friday, and was snapped up the following Monday . . . fast work, eh. . . ." So, me hearties, there you are. Pleasant being right occasionally, even tho' my ex-YL won't give me credit.

CLASS: Who has a schematic diagram of a TRF receiver using a 6D6 r.f. stage, a 6C6 detector stage and a 43 pentode power output; using a 50X3 ballast and a 25Z6 rectifier. This is for a.c.-d.c. use. The inquirer would like to use a half-megohm volume control as an "audio shunt" instead of a 25,000 ohm "antenna-cathode shunt" if feasible. If any of our bright students have the answer, how's to pass it along to Charley Odell via ye Ed. He would appreciate it powahful much.

FB Bock, Chief Op WPGN, the sleuth station at South Bend, Ind., tells us that he's been up to his ears trying to please the new Police Chief with some special remote control equipment. He sez, "It took plenty of that 'midnite oil' to work out a good system." Then when he completed that chore, along comes the city of Mishawaka into the network and some more remote work had to be figured out, with special attention paid to keeping the cops from interfering with one another. Special relays had to be put into the system for this purpose. Also, Brother Bock uses his spare (?) time instructing the whole police department on how to pass a third class ticket examination. Just a guy who hasn't the time to get into trouble. Yo ho ho for the life of a police op!

AND speaking of cops getting in each other's hair, comes the beef from Lorain, Ohio's police department that the Beverly Hills, California, police radio dispatcher is causing them to go galloping off to an emergency which is happening in the land of sunshine. Because these two stations are on the same high frequency channel, the Ohio squad can hear the Californians so clearly, especially between 3:00 and 5:00 p.m., that they have to make sure of the station's call letters before chasing out on the call. 'Tis sad a fence can't be put up high enough to stop this interference, what.

A NEW field for radiops will be opened if and when an experiment now being conducted by the Central Railway Signal Company of Proviso, Ill., proves successful. They were recently granted a frequency by the FCC. The purpose is to insure radiophone

communication between the central control tower of a railroad freight yard and the locomotives therein; to transmit messages which will consist of orders relative to the classifying and sorting process in moving freight. Playing nursemaid to a couple of locos won't be hard to take, especially if the pay is right, methinks. At least, it'll be a permanent shore-side billet.

ANOTHER new field for radiomen and technicians is *Frequency Modulation*. Here is what the FCC said when they granted 40 channels to this latest radio child, "Frequency Modulation is highly developed. It is ready to move forward on a broad scale and on a full commercial basis. On this point there is complete agreement amongst the engineers of both the manufacturing and the broadcasting industries. A substantial demand for FM transmitting stations for full operation exists today. A comparable public demand for receiving sets is predicted. It can be expected, therefore, that this advancement in the broadcast art will create employment for thousands of persons in the manufacturing, installation and maintenance of transmitting and receiving equipment and the programming of such stations." We have it on good authority that these stations will be in demand in outlying communities which are not serviced by the major networks and in larger cities which wish to blanket a definite area without having to pay for useless overlapping territory. Ye ed understands that this field will be fully developed and that radio set manufacturers will build receivers so that they will accept these high frequency broadcasts.

RADIO Inspector B. H. Linden wishes to announce to all and sundry that the "hams" in his district, 11th Radio District, comprising the lower half of California and Arizona, are a bit of all right. Not a single unlicensed op operated not a single unlicensed station for some time past and this is a darn good record. He advises the gang that the FCC is going to be especially tough during these trying times. So if any one should feel irresponsible or giddy enough to operate illegally, or to permit any one else to operate illegally, the culprit is going to find himself facing a sentence of a \$10,000 fine and two years in jail. Also, the felony mark would be carried through life. So beware, beware. . . .

UNION organizations, just like any other type of business, have to "sell" men the idea that joining their organization is the best thing they could do. Many are the reasons set forth, everything from brotherly love to utopian security. But the *CTU-Mardiv* gave one of the best selling arguments yet unfolded, we think, which reads, "After we signed up the *Socony-Vacuum Oil*, the *Isthmian Steamship Lines* and the *Cities Service Oil Company*, increases in pay amounted to as high as \$15.00 per month per man, or \$180.00 per year. Our dues being what they are, it means that these men have made seven and one half times their investment. Where could one invest \$100 and receive \$750 with such good security as we can offer them?" Which ain't bad, considering the *CTU-Mardiv* personnel are only radiops! We'll give you the *ACA's* sales talk next issue just for a pep talk. And until then, remember, keep plugging and you'll win. So with 73 . . . ge . . . GY.

Building a SIMPLE SUPERHET

by ARTHUR HERTZBERG
New York City, N. Y.

Simplicity was the key-note that the author tried to reach in designing this superhet for the experimenter, and the music listener.

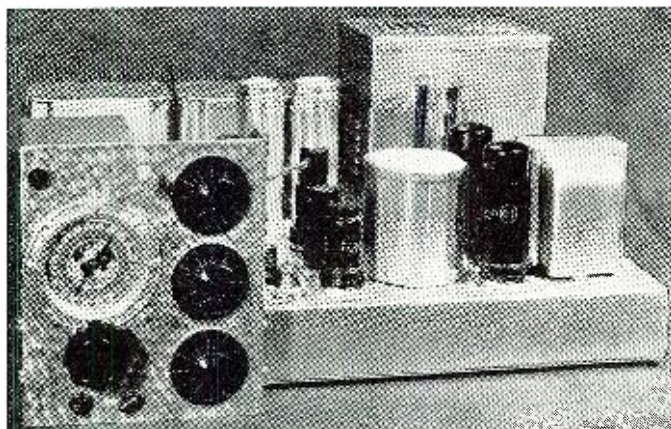

The super has no cabinet, making construction cheaper.

BY the nature of things, the advertising departments had the engineering departments licked from the start. As far back as 1928, before the depression really hit the radio industry, one manufacturer brought out a set with a push-button tuning system. At the present time, as a result of a handful of minor technical achievements and a great deal of creative labor by the advertising geniuses, a broadcast receiver may contain any or all of the following "features":

From one to four extra wave-bands.
Superheterodyne circuit.
Automatic volume control.
One or two tone controls.
"Magic eye" tuning.
Push-button tuning.
Remote control tuning, with or without external cables.
A variety of speaker housings, all

supposedly endowed with miraculous properties.

My firm, though possibly naive conviction is, that every one of these is so much window-dressing so far as the average listener is concerned. They are on a par with the frenzied claims issued by cigarette firms, cosmetic manufacturers, and vendors of tonics guaranteed to grow hair on the old eight ball when you wind up behind it. They gild the lily and likewise the inside of the serviceman's pocket. Fortunately for the consumer, the fundamentals of receiver design have been so well established by disinterested scientists, that the sets work surprisingly well in spite of these "improvements," just as a modern automobile runs well, even if you can't see where you're going on account of the "streamlining."

Having thus demolished a number

of major industries, and preparing to wreck one or two more, let me throw in a word of praise, faint, but not too damning. My argument is not that the manufacturers of broadcast receivers don't give satisfaction, but that they give too much, like a double-feature movie show or triple-decker sandwich. By and large, present-day receivers are a vast improvement over those of ten years. They are not, however, much improved in either fidelity or ease of operation over models four or five years old, despite all the ballyhoo. Of abominations like the short-wave-length bands, with their associated headaches of superheterodyne, avc, and whatnot, I will not long speak. Together with tone controls (imagine further emasculating an audio range almost too narrow to begin with), these are the things which the average
(Continued on page 48)

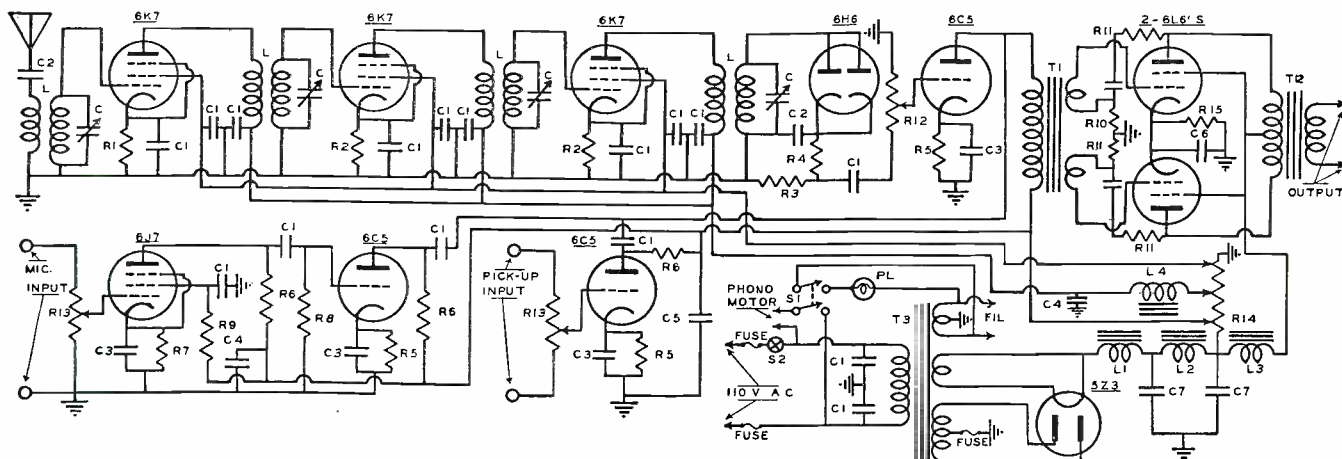

Circuit diagram of the superhet receiver.

C₁—4-gang .000365 mf. var. Reliance
C₂—0.1 mf., 400 v. Solar
C₃—0.001 mf. mica. Solar
C₄—10 mf. 25 v. elec. Acrovov
C₅—1.0 mf. 400 v. Solar
C₆—0.5 mf. 400 v. Solar
C₇—25 mf. 50 v. elect. Acrovov
C₈—8.8 mf. (both sections used in parallel to give 16 mf.) 450 v. Acrovov
R₁—10,000 ohms, 1/2 w. IRC
R₂—300 ohms, 1/2 w. IRC
R₃—50,000 ohms, 1/2 w. IRC

R₄—200,000 ohms, 1/2 w. IRC
R₅—2500 ohms, 1/2 w. IRC
R₆—100,000 ohms, 1/2 w. IRC
R₇—1000 ohms, 1/2 w. IRC
R₈—500,000 ohms, 1/2 w. IRC
R₉—1 megohm, 1/2 w. IRC
R₁₀—5000 ohms, 1/2 w. IRC
R₁₁—45,000 ohms, 1/2 w. IRC
R₁₂—500,000 ohms pot. Centralab
R₁₃—1 megohm pot. IRC
R₁₄—25,000 ohms, 75 watts, voltage divider.
Ohmite

R₁₅—200 ohms, 10 w. Ohmite
T₁—Input trans., split secondary. Amertran
T₂—Output trans., 5000 ohms primary, 12 w. rating. Amertran
T₃—Power trans., 800 v. c.t., 250 ma. Thordarson
L—R.F. trans., 500-1600 kc. coverage with .000365 mf. cond. Meissner
L₁—5-25 hy. swinging choke, 200 ma. Thordarson
L₂—20 hy. 200 ma. Thordarson
L₃—Speaker field, 1000 ohms, 150 ma. Utah
L₄—10 hy. midget choke. Thordarson

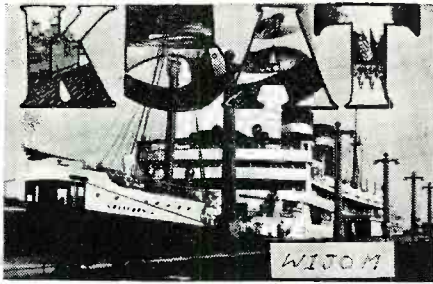

K5AT's vy fb qsl card.

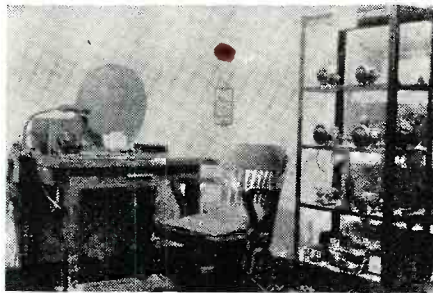

This is hamstation W1UDU.



Hamop W5HUQ es his hamrig.

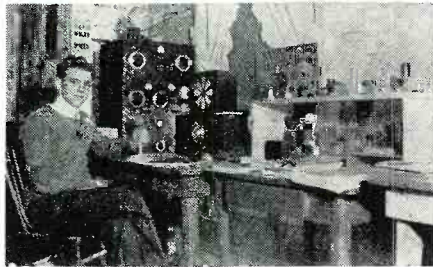

Hamop es station W9UGR.

H A M C H A T T E R

FCC CRACKS DOWN ON HAMS!

Washington. (Special to RADIO NEWS) The Federal Communications Commission today ordered all U. S. hams, of which there now are over 55,000, to stop communicating with any foreign stations. This was held to mean all foreign stations, and not only the belligerent countries. The order was effective at once, and was passed as a part of the plan of the Administration to prevent 5th Column activities between any subversive elements here and elsewhere making use of the wide-spread and far-flung amateur networks.

In a subsequent decree, the F.C.C. also ordered all amateurs to cease all portable and mobile operation except in frequency bands of 56 MC and higher. Exceptions were made for portable operation during June 22 and 23, the A.R.R.L. Field Day Tests. This move was to further the prevention of subversive 5th Column activities. It was stated that no general shut down of the hams was contemplated.

WITH the organization of 100,000 Wisconsin riflemen as an anti-parachutists corps, the thought occurred to us that the hams could also be so prepared. With each and every ham on the lookout, it would be hard for any parachutist to land anywhere without the word being passed around with the speed of light. Not that there is any immediate danger of this happening. But after it has happened, then it is too late. All those in favor of organizing a *Radio Hamops Anti-parachutists Corps*, are urged to write either this column or to the ARRL. In either event, this column will cooperate most closely with the ARRL in furthering the information received, and the names of those who wish to serve to the proper authorities. It may be suggested that the R.I.A.C. be not limited only to hamops, but to any persons who might have access to a hamop station by virtue of living near one. Watsa fellows?

WHILE it is distasteful to mention the Second World War, still, since the President has appealed for 1,000,000 trained technicians, we feel that a few words about the hams and their rigs would not be amiss. Those who can remember, will recall that during the previous World War, some 13,000 hams served with the colors. That number will be small potatoes this time!

What to do, what to do?
Well, firstly keep calm.
Secondly, bring all your equipment up to date and in first-class working condx. That will be a real service to Unca Sam if and when he may requisition it. Next see if the family budget won't stretch to include a perfectly working complete QRR rig of light weight and so designed that it requires no use of any land power lines. Next, with the QRR rig working and your own rig in tip-top condx, register both with the A.E.C. of the American Radio Relay League, West Hartford, Conn. They already have thousands of QRR men & rigs on record, and there would not be any reason to have the list divided between that organization and that of R.N. By doing those things you can best serve your country now, at least until such time as something definite comes from HQ.

LARRY W2IOP Kashman berles up de mail wid exclamations of horror! Sez he, "NY2AE ant no ARMY station, itsa Navy one!!!" Sorry, Larry, but we didn't catch that one befo it got into print. You, and your education! Hi! 'Twont happen again!

"A slip of the tongue is no slip of the mind!"

IN last month's HC, the name of *Walter H. Candler*, founder of the famous *Candler System* was misspelled so many times that the HC Editor has a permanent lobster-like glow on his face. To his many friends this happenstance was obnoxious, and to them and to his widow,



Recently hitched, W1MIG es his XYL.

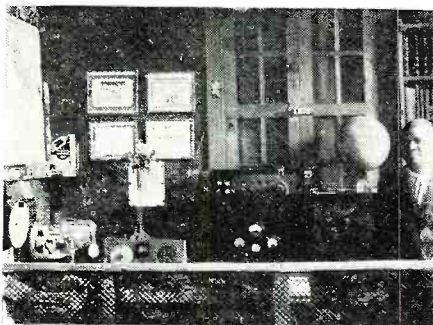

Hamop HH2MC es his fb shack.

TWO issues ago we made a plea for some operator in the vicinity of Boys Town, Nebraska to come forward and volunteer to become trustee for a hamstation which was to be erected there. To date not a single ham has volunteered! We cannot bring ourselves to believe that there is *not a single ham* in or near Boys Town! There must be *one* among the 55,000 hams in existence. Watsa matter with you fellows: Don't you want to help those less fortunate than yourselves? Till a trustee is found, the worthy institution of Father Flannigan must wait for its equipment which will be furnished to them gratis. This is a sad state of affairs, and should be rectified as soon as possible. Someone once said that hams were "brothers of the Hertzian Waves." Well, let's be brothers. How about lending a helping hand? Volunteers are urged to write to either this column or directly to Father Flannigan, Boys Town, Neb.

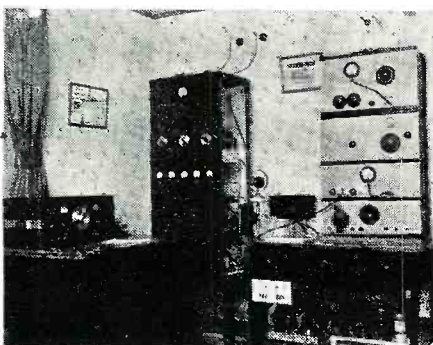

The neat layout of hamstation W1HDJ.

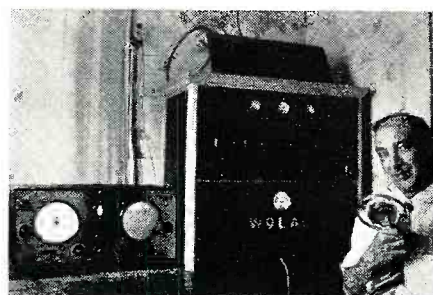

Hamop W9LAC at the mike of his rig.

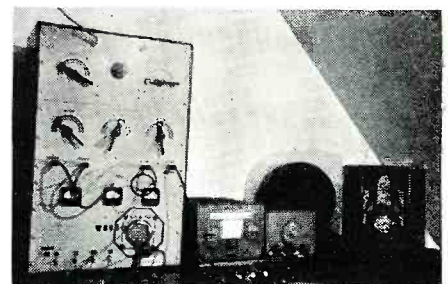

Hamshack of W8OGG.

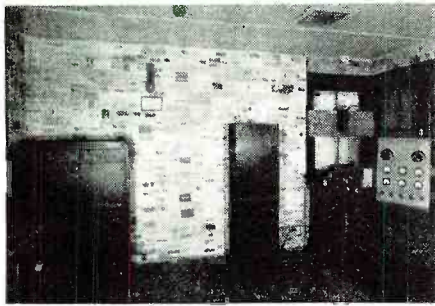

The "QSL Wall" of hamshack W2AIW.

Mrs. Candler, we apologize. *The Hamchatter* Editor.

FREE foretelling Dept.: We hereby stick our unshaven necks way out to here and prophesy the following, that:

1. The hams will not be put off the air even if we declare a national emergency!
2. The hams who are not enrolled in the Army Amateur Radio System, or the Naval Communication Reserve, eventually will be legislated to 10 meters and above.
3. Only Army and Navy network men will be permitted to operate in the 80 and 20 meter bands.
4. Forty meters will be lost to the hams for all times.
5. One—Sissie will go over to the police bands.
6. Five meters will be a FM—Class B band.
7. Ten meters will be a class A band.
8. Code speed for a license will be upped to 18 w.p.m.
9. Two-anna-half will be required for local ragchews.
10. All power outputs except for Army and Navy networks will be limited to 100 watts input to the final.

If anybody wants to argue, send in your reasons. Our reasons are from long range deductions and the little birdie who told us the above hasn't been wrong yet.

AT the May, 1940, A.R.R.L. Board Meeting, one of the pet projects of *RN* was adopted. It was voted to appropriate \$10,000 to the use of a committee of one, namely, newly-elected-ARRL-President George W. Bailey, to be used in protecting the ham frequencies from incursion in any emergency short of a War Emergency. This was for many months a proposition advanced by the now dormant *National QSO Page*, and to say that we of *RN* are pleased to see that the *ARRL* has finally seen the dangers and moved to counteract them, is to put it mildly. Our sincerest compliments to the *ARRL* Board for awaking to the dangers that beset the ham, and we hope that with national unity being achieved in the year 1940, that the Hams and their representative organization, the *American Radio Relay League*, will each put their shoulders to the wheel and pu-u-ush for the common good. More power to them!!

QRM from the 5th district by W5HMV Windy Bill Waller.

We have often wondered what these Latins have that we haven't but after one look at TIBAV's Pic we know. Arturo has been holding skeds wid W5HMV for many months on 10 meter lone thereby enabling him to keep in touch with his brother who attends L. S. U. Arturo runs abt 400 watts to a pr. of T55s. He says he has lots of trouble wid dampness getting into his recvr. es transmr. es ruining his trnsf. W5HAD really has a swell layout way up in the wilds of Miss.

W5AGY really has a neat trick of getting visiting hams to make impromptu recordings as W5FVK es W4BGO found out. The ladies in the dressing room where he rigged up a mike will probably never hear theirs (some fun, eh! kid?). W5DAN thinks that nothing will promote hammy like a club call es Xmmitter. W5CQJ is renewing friendship on 160 after a stay on 75. W5CDZ really has a swell ant. es rig. W5FWD is on 160 lone wid an 807. W5GXO es W5DAN gave W5HMV a surprise visit.



Jr. op of W7FHC QSY's via hoss-back!



Hamop W5IFH and his fb rig.

W5HEJ es W5HEK the old swamp angel es his mate are still going strong on 160. W5HHI had the very amusing (?) experience of walking into a newsstand es asking for a copy of *RN* whereby the clerk asked Edith did she want to buy it or just look.

W5FXF is a confirmed e. w. hound. W5BRR really had some tough luck wid his kw. 20 mtr. rig during the recent DX cont. W5FPO will be recognized as the op at W5ISC by his many old friends on 160. W5ISC is W5FPO's daughter. W5AXS after a long struggle has become net control for the Sun. 75 lone net. W5HUY is really an early bird on 160 says bels keep him off at nite. W5HVI's many bel listeners will be sorely disappointed to find Dean has changed his QRA. Dean says he will hv more freedom at his new QRA.HI. W5HMY went to Miss. es met W5EKV es W5HAD es to his surprise found the boys hadn't been bragging over the air to him but they actually did have on shoes. W5GIZ has completely disappeared from the air.

W5GEF finally broke down es got him a first class revr. W5HMZ has a Hutson lab. Xmmitter. W5HQC really puts out a swell rig. W5INN, W5HFI es W5HZY are all on 160 in St. Joseph, La. W5HEZ is now on 10 mtr. lone. W5FCH is P. I. inspector in McComb, Miss. W5BV really can dish it out on e. w. W5ADJ has gone in for loop receiving ants. W5IGJ is still trying to get on 10. Hl. Harold! W5GJ is still holding dwn 1925. W5WT paid W5YI a visit. W5HZP wants it known he is in Houston, Miss. es not Houston, Tex. Dick Taylor, Alexandra, La., is an ardent *RN* fan es SWL. K5AT is going to town on 10 lone. W5WN says a little drink won't hurt anybody. W5FIZ is still doing OK on 160.

VIA W6LMD:

W6HKA has again qsy-ed. He is now located in Vallejo, and is buying a new home there. Bet its a good spot for a nice beam. W6GPB is taking advantage of the lull in dx to rebuild his exciter into a signal shifter. In "Radio's" dx contest he not only added a few new countries to his list but made a score of 34,000 points. He was also in the "SS" contest. Recently he was appointed assistant *SCM* of the San Francisco *ARRL* Section. W6MFD invested in one of the new *sky-buddy* receivers and is very well satisfied with its performance. Hears signals now that he never knew were on the air before. W6MFB is talking about acquiring a new signal squitter and receiver. Also wants dope on Radio controlled model power boats. [Read *RN!* Ed.] W6QYU, Lumber Jack DeLuxe, claims his dx on 80 meters is New York and California on 40 meters. Uses a *SX16* receiver and a little 25 watt rig. W6AOF acquired a new three element beam. All he has to do now is to put it up. Then he will work some dx, he hopes. W6LDC remodeled his rig with excellent results. The gang on 80 meters can really hear him now. W6BFZ also qsy-ed and is busy setting up his rig. The basement has a concrete floor, which isn't so hot, but an oil stove and rug will solve the problem. W6FQU says that one definition of a "Ham" is: *A feller that sends with the speed of lightning and receives by mail.* Ain't it the truth! W6PVC has his rig going on ten lone with the rest of the boys but has a little trouble



This is what W9DPU thinks of when the ham rig just wont perkolate.

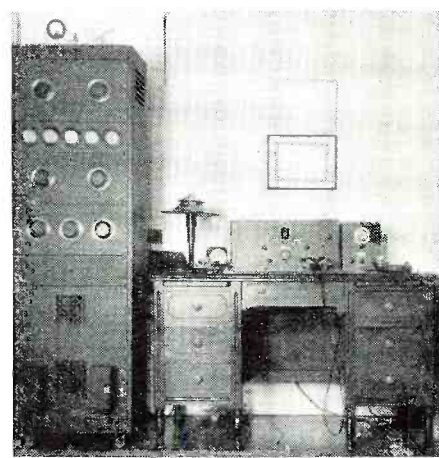

This beautiful layout is W2BJ's.



Hamstation layout of W7HLH.



The ship-like hamstation of W2CMY.



W5DRZ leans against a vertical 40.



"So he says, 'Operating mobile, eh?' . . . then he gives me the horse laugh!"

hearing them. Guess he will have to do some work on his RME or something.
 W6FVK is the new president of the *Marin Radio Amateurs Club* for 1940. Ask him about that "G" that was calling him. He likes to talk about it.

The Iowa-Illinois Amateur Radio Club of Burlington, Iowa, meets regularly each Friday evening at 8 o'clock. Our meeting place is the *Police Court Room* on the second floor of



W9WSH, hamop of California, MO.

the *Police Station* and we cordially invite all hams in this vicinity to visit us. The invitation goes double for any other hams who may be driving through Burlington. Drop in and meet the gang. If you can't find the station, just run a few stop signs and you will be given a private police escort to the court room, hi!
 W9WNL has undertaken some major rebuilding. First it was the modulator, then the final and now he is working on his ECO, trying to improve its quality, especially on 80 meters.
 W9SHY is heard occasionally on 160 fone and 80 c. w.
 At a recent meeting, W9TMY, W9WTD and W9ALC combined equipment to give the club a demonstration on how to adjust a phone transmitter by using an oscillograph. This proved



Voice from the speaker: "Look out fer the dum cluck cop on the corner!"

to be very interesting and educational to many of us who had never seen an oscillograph in operation.

W9QGU, ill with the mumps, had to stay home from Junior College for a while, but it gave him lots of time to operate his rig on 160 fone.

W9RZV has a brand new SX-25 receiver and it gave him his first real opportunity to investigate the 10 meter band. Result: A new final and modulator planned to follow his small rig and lots of ideas on rotary beams.

W9LAC finally got all the bugs out of his rig and it works swell on both 20 and 10 meter fone. Doc bought a sheet of brass and is spending his spare time now grinding electrodes for crystal holders. He builds them in old tube bases.

W9GKN is another ham who had to lay off due to an attack of mumps. Slim has the rebuilding fever and also has his eyes on a Class A ticket. He hopes to give 20 fone a whirl.

W9IBH, Iowa's Best Ham, has a new *Stancor* 110-CM rig and has it operating on 160 and 10 meter fone.

W9ETS has his rig built but had a hard time getting rid of downward modulation. It is apparently OK now and it sounds fb.

W9BEV, *Burlington's Hard Worker* drives a city passenger bus and has had many fine QSO's with some friends who are also bus drivers down in Oklahoma City.

W9DVP is still investigating circuits for that new rig. He will probably use a 6L6 and 807 combination.

W9ESF is off the air temporarily due to rebuilding.

W9HQO made a swell mike from a crystal earphone and now broadcasts every sound in the house.

W9PJK has been sick for over a month and we sure miss seeing him at club meetings. We are glad to hear now that he is up and around again.

W9C7Q burned out his modulation transformer but has another and is back on 20 fone again. Also new is a 100th final. He is planning a vertical antenna for the 75 meter band.

W9OMF now has a T55 final on his 160 meter fone rig.

W9KYR is still talking about the R9 report he got recently from a W3 station while operating on 75 fone. Frank runs about 35 watts to an 807.

W9ESH denies it, but they say he keeps a pigeon in his transmitter, and if the poor bird escapes Charley knows a wire is missing! hi!

The fellows in Fort Madison, Iowa, are very happy about the whole thing because they are getting 60 cycle current. No more extra charges for 25 cycle power supplies from now on. They say 60 cycle sounds like PDC to them after filtering 25 cycles for so long.

W9FZE averaged 8 QSO's per day during the month of March, which when laid end to end amounted to a nice light bill! Ray is considering a new receiver.

W9VQJ is collecting circuit diagrams for exciter units and plans to build something soon.

W9WMP gave his new ECO exciter a good test in the recent ARRL DX contest and had excellent results. He is also planning a rotary beam for 20 meters.

W9QQQ has finished his new all-band rig and says it works fb.

W9PHA finally got the panel for his new rig and is about through rebuilding. The rig is crystal controlled and has output on four frequencies in each band from 160 through 10.

W9WHH has a new *Silverstone* Communications receiver and likes it very much. He says he is amazed at the way the crystal filter splits the QRM on 160 fone at night.

W9JIS has a new low powered rig for 160 fone and leaves his big rig on 75 fone.

W9TFW got REA down his way and can now run higher power to his Xmrtr and take the batteries off of his *Sky Challenger*. He is getting his first taste of line noise now.

W9DRT didn't get REA but sure puts out a swell signal. He has hopes of getting a Class B ticket soon.

W9ECZ and XYL, W9MRO, have moved to a new QTH and haven't been heard on the air for a long time.

W9BOD has a consistently good signal on 160 fone and is building a high powered rig.

W9CVS is attending college and only gets on during occasional vacations.

W9GSA moved to Roseville, Ill., and is on 160 fone very often.

W9MGI handles lots of traffic on 80 c. w. but likes 160 fone for a change.

W9CWV is heard on 160 fone and c. w. W9JSC has a cathode-modulated rig on 160 fone and is having very good results. He has worked lots of DX on 10 fone.

Most of my activity lately has been on 160 c. w. talking to the fellows in and around Burlington, but I still give 40 meters a whirl occasionally. Have also been helping a would-be ham with the code. So its 30 for this time. Vy 73 de Dick, W9QVA.

By W7FHC, Luther, Montana:
 Well, the O. M. will rattle off a little more Hamchatter from the Seventh District again. Seems like that it is a little too much like last month over again, but next month we hope for better, as quite a number of the boys have promised me pictures of their rigs, and their selves and I would not be surprised if some of these wild western cowboy hams don't send me their picture riding horseback while listening to a portable radio. (Would you print such a picture, Ed?) [Youse'dit, cowboy! Ed.]
 W7HQJ who pounds brass for the *Western Union* when he is not hamming has grown from 25 watts output to 150 watts in the last year,

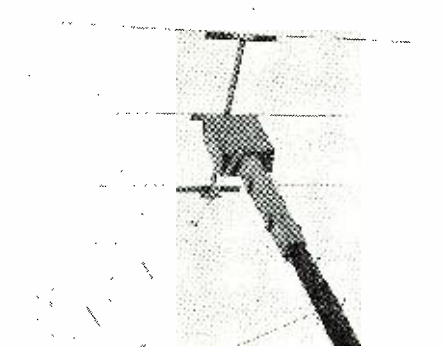

W9KOH's roto-antenna.

and is now working some dx in the early morning hours as he gets off shift after midnight.

W7C7P, W7GLM, W7BNL and W7GFB have all got *Class A* tickets now and are making arm on 75 meter fone, especially rag chewing on Sunday afternoons.

W7FFB the *old big fish catcher* has got his RK-20 on the air again after being off the air for quite a while moving his qra and changing the rig some, and maybe casting a few flies in between.

W7DIF has stepped up his power lately to 250 watts and reports that he is getting out better, but don't seem to make much difference in his signal here only about one r.

W7FL, one of the two letter call boys, is on 75 meter phone once and a while. Wonder what band he is on the rest of the time. Probably he is doing like a lot of the other sevens, getting his horse and lariat ready (transmitter is the horse and receiver is the lariat) to see how many stations they can snare this summer.

By the way, since I have mentioned ten meters, just as well get it off my chest now as later. Seems like some of the W1's and W2's seem to be under the impression that the W7's do not qsl like they should on ten meter. Even went so far as suggesting maybe the W7's were using gold ink. Well, I took it up with the W7's who work ten, especially the Wyo. cowboys, gold miners and trappers, and boy, oh, boy, did they get riled up and if it wasn't on acct. the F.C.C.'s regulations I sure would've heard some tall cussing and I don't mean maybe. Then it finally got boiled down to this, and it's a pretty bitter dose for you W1's and W2's. Seems like if you want some cards from your ten meter QSO's you had better send some out this way and don't always wait till you receive one. One W7 said he has got about 15% returns, so come on you hams, send some qsls out this way and you won't need to worry about the gold ink; you will get the cards.

W7FDD has got his apparatus to working again and is really boiling in here.

W7GLP is also putting in a good wallop in this neck of the woods.

W7GFM has got his ECO on the air now. If he stakes his big horse too near your pony just give him a shout and he can move him over a little.

W7HPE has been experimenting with different rectifier tubes and working 40 and 80 meters c. w.

W7AIR is another one of the old timers, who has been building himself a new receiver that will work on ten meters and has also been reducing the noise in his a.c. power system which he runs with a gas engine. Hurry up, and get that old transmitter tuned up and on the air W7AIR!



W5CGW and his vertical 20.

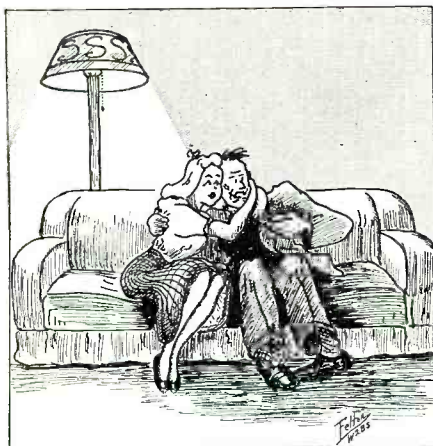

"But, Honey, I just gotta go. . . . I must attend the A.A.R.S. drill now."

I have been informed that W7FFW has been appointed District Net Control Station Number one, and W7DAJ will be District Net Control Station Number two. Seems like that the army net frequency of 1945 kc. is clearing up some at drill periods Monday evenings.

W7AMU and W7AAT are working on a proposition to put us fellows (AARS) into the Ninth corps area instead of the Eighth corps area as we are working now.

W7HWI is one of the new hams heard lately on one sissie.

W7HVA is operating on 160 at present with about 100 watts to a TZ20 in the final.

W7CZJ has got his sky-wire up again after the wind broke it down and is now working out, fb.

W7MAV portable has a new 10 watt Stancor kit built up and is coming in fine here mornings when qrm is not too bad.

What are you using out there in Ore., W7GLX, since I hear you in here at q5 R8 at 8:30 to 9 a.m.

Wish to congratulate W4EXH of Lexington, North Caro. for the way he was putting in a Q5 R6-S signal on 160. Wish I could have done as well back there 'tother morning.

W7HGX portable has his station at a CCC Camp and promises us some pictures for next issue. Besides operating his ham station he is Sgt. in the CCC, plays trumpet and sax in orchestra, and writes songs. Looks like he is one busy ham.

Well, I have been playing around with a genemotor for power supply trying to see how far I could work out on 160 phone with the smallest power. Best I have done to date was W6OXG on 2.7 watt input. Got Q5R5-7 and then I reduced to 1.4 watts input and got a report of Q4R4-5. I just hooked the flee power supply right on to my transmitter that is designed for an input of 35 watts, only had to turn up the mike gain.

We are sorry to hear that W6OXU had the tough luck to lose his ham outfit, hamshack, transmitter, receiver and other valuable ham equipment, in a fire, right after the qso, but we are sure glad to hear that he has a new hamshack built, and is building on another transmitter. Which all goes to show, as the saying goes, "That you can't keep a good man down."

SPEAKING of woods, one of these woods kittens with the Samson odor, came up out of the woods and slipped into my shack one evening while I was out, and when I came back he had possession and I did not argue with him, as I did not want to bury the whole shack and contents. So just left the door open and he only stayed about a week. Have any of you other hams had any unwelcome visitors stay that long with you without even an invitation. Hi! Hi!

My son has his belt on a board now, so I'll bet we won't be bothered with him; but sure am keeping the hamshack door shut better now, as he may have some friends that don't have any better manners than he had.

W7GZI is working ten and 160 meters now and reports working New York on ten since he has boosted up his rig with a new HY40 tube in the final and is running about 95 watts now.

I hear W7BZT on the 75 meter phone band working out, fine biz. Says he has two 203A's in final.

W7CT is also on 75 meter phone most of time; also W7GLM.

W7GKC who used to be at Billings, has moved back to Iowa.

W7HNW is coming in here fine and says his SX16 receiver is working fine biz.

W7FFW reports that he has been going around in circles trying to kick his own pants!! Reason for the pants-kicking seems to be that he made a sked on ten meters to talk to a K6 on 160 meter phone in the wee small hours of the morning. So he sets his alarm clock and went to bed and how he did sleep. When he woke up in the morning the sun was shining and the alarm clock had stopped just a few minutes be-

fore it was to have "alarmed"; and how would you have liked to have been that alarm clock? Yep, that's right, it is just a flat piece of tin now! Hi!

W7PFB is on the air again and reports having doubled to ten meters from 160 meter band.

W7GPM and W7EYR are experimenting with ECO's on 160, and you are apt to find them any place on the band now.

W6QUA is still working portable W7 but expects his new W7 call soon; he will probably have it by the time this is in print.

I hear W7CXR in Washington coming in here fine biz on 20 meter phone. Ditto W7AKQ. Not very often we hear many W7's in here on 20 meters. We hear mostly W6's and eastern stations.

W7EKR is on the 160 meter band about every morning now rag chewing with the gang—he works his dx on 80 and 40 meter c. w.

W7HKL has got his new qsl's out now, so if he owes you a card, and you don't get one from him soon now tell him about it and make him come thru.

CLEVELAND'S newest and most successful radio club, *The Cuyahoga Radio Association*, held its 4th meeting March 27th at Mills Dutch Room. The 5th meeting was back at our regular meeting place, *Red Cross Headquarters*, Cleveland.

W8DS, Club president, announced somewhat blandly recently, that he is actually going to become a c. w. man. To date his key is still 2 feet high on a shelf.

W8FFK is Club Chief Operator. An ex-commercial op, A1 opr. and active phone and c. w. man. Rolly is an excellent choice for the position. He will have charge of the proposed Club station and any club sponsored portable station participants in organized activities.

The 3 ECLs who complained, most bitterly about qrm from W8GKG in the past years have all passed on shortly after making their kicks. Bob feels keenly about any more bels who may have cause to complain.

W8KC, after being inactive for the past year is back on again with a pair of 810s and cathode modulation.

Since W8KO, the new Cleveland R. I. came to town, the local boys have been retouching their rigs. One chap changed his whole tube line-up as he suspected the R. I. wouldn't like the looks of that 3 KW bottle in the final, even though it usually runs well below the legal limit.

W8TMA said, "What happens to me shouldn't happen to a dog!", when he learned the R. I. chose a qth right around the corner.

W8TMI, Club secretary, is looking for a qth with antenna room.

Ex-W9EPP, Len used to have 6 acres around him out west, but the Cleveland apartment has sure been a change. The wide open spaces again beckon him.

W8TAY, W8SSV's XYL is asst. Club Secretary, and doing a fb job of it. She'll soon be on 80 with an ECO.

W8DGP, W8KOL, and W8KC all have new SX24s.

W8CTI fell down a flight of stairs while carrying a refrigerator. He's out of the hospital by now, as heard him on the air recently.

W8QLN builds 'em up and tears 'em down. He turns out some beautiful jobs even if he never operates them!

W8HBH, W8LZL, and W8LYI, work for Cleveland's new radio parts jobber, *Progress Radio Supply*.

W8PWS, W8OYM and W8PAL work for *Radio Servicemen's Supply*, Cleveland.

W8HSX sells radio parts at *Goldhamer, Inc.*

W8LXZ does the same at *Radio Tubes Distributing*.

Cleveland's YLs now include, W8ODI, W8PXE, W8PZA, W8QHN, W8SBB, W8TAY, W8TLE, W8UCY. All married but QHN, SBB, and UCY, so W8TAY tells me. She sez UCY mighty sweet little student nurse. UCY is W8TLQ's sis. Take it easy, you single guys!

W8IRM and W8GPB both jumped into the sea of matrimony lately.

W9DLW, Ex-W8HFE, is now pounding brass for *American Airlines* in N.Y.C. Bob expects have the ham rig on from up east soon.

W8QAP, Ex-W8KZL, recently changed qra from Arizona to Los Angeles. Hope to see Bud home again next summer.

W8EBY is President of the *O.S.U. Radio Club* at Columbus. He does his brass pounding at W8LT while at school.

W8GCU is another of the boys who slipped quietly into the ranks of the married men. Dick works at *W8K*, local biz station.

W8KKQ has his rig on at Wittenberg University while at school. Works 80 most of the time.

W8IOK, after about 5 years absence, is returning to the ranks. He's getting anxious to pound the ole key again.

W8EFW, has an ECO on 80 and thinks it's the nuts. When he's not on the road peddling radio parts and equipment, he pounds a little brass on 40 and 80. Will have a portable rig soon to carry with him while making road trips.

(Pse QSY to page 60)



"I know it's for National Defense, but must you... at a time like this?"

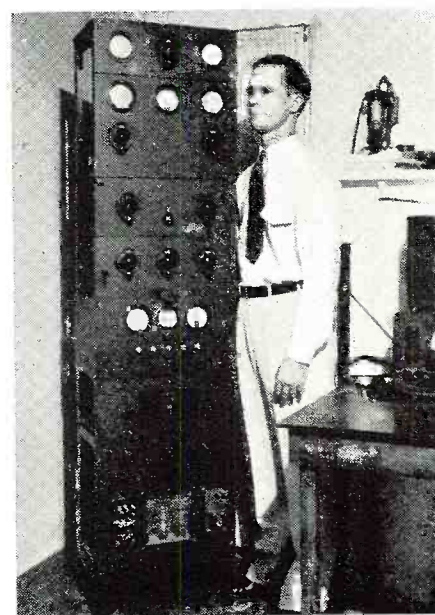

W7AAT's rig is really biggern him!

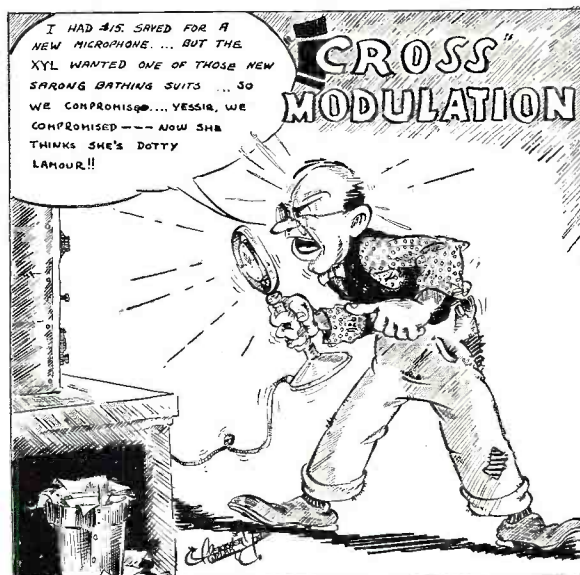

Notes on the MARINE RECEIVER

by **RAYMOND P. ADAMS, W6RTL**
Hollywood, California

Those who built the marine receiver of 18 months ago will welcome these additional notes on the loop, and how to improve it.

IN the August and September 1938 issues of RADIO NEWS, the author described the construction and application of an all-wave marine receiver designed for optional radio-compass use and equipped with a plug-in loop assembly for the directional reception of both standard broadcasters and long wave stations.

Late experiments with the laboratory model—conducted since publication of the story and undertaken following the receipt by the author of certain advice and suggestions from the United States Lighthouse Service—have indicated that radio direction-finding against stations in the broadcast or higher frequency bands is subject to wide and unpredictable variations which can be only avoided by

the very skilled engineer or operator and then only with considerable difficulty. It is therefore suggested that the amateur yachtsman (for that matter, the skilled navigator) who plans the construction and radiocompass use of the MARINE-HAM RECEIVER, which was the set described, build a loop which tunes only to and through the 285-315 KC band — and that he rely for accuracy upon the regular, established radiobeacons which are operated by the Lighthouse Service solely for his safety and aid on frequencies within this relatively narrow portion of the spectrum.

No loading coils and no coil-selecting switch will be required. The effective loop circuit, in other words, need not be tapped except at center. Precise inductance is suggested for resonance at the approximate band center, if an untuned loop is to be used; and if a tuned loop is called for, the amount of tuning variable capacity range will depend the coil's inductance and the initial or tank C (fixed) providing for a suitable high frequency limit spotting. Due to the excellent long wave selectivity of the receiver proper and the very careful scheduling and grouping of the radiobeacons the untuned loop idea might seem to be the more practical one if for no other reasons than that it reduces the number of controls to minimum and makes possible a relatively easy input assembly construction.

It is suggested that a much smaller loop than the author's original job be built, and that trial and error design (a turns formula doesn't seem at all practical—due to the uncertain capacity effects of the necessary shielding) precede the completion of a final assembly. The block-jointed *Textolite* tubing idea will with copper screening be satisfactory; or one may feed the wire through a one inch O.D. soft cop-

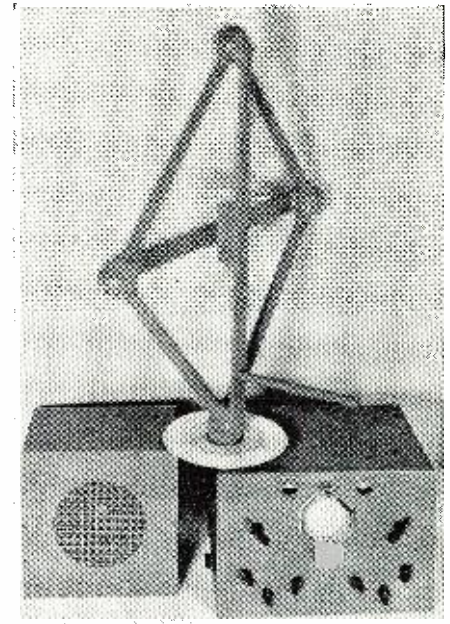

The receiver described by the author.

per tube — the tube formed into a round loop of suitable size.

Remember that the shielding must *not* be continuous in the plane of the loop; a one or two inch window will be required if the loop circuit is to pick up signal energy when in off-null positions.

One important point related to the proper installation of the MARINE-HAM RECEIVER aboard-ship was not brought out in the original article, and we'll very briefly mention it here:

The installation of this or *any other* direction-finder on any vessel, large or small, always requires an initial calibration so that the instrument can be marked or adjusted to care for the

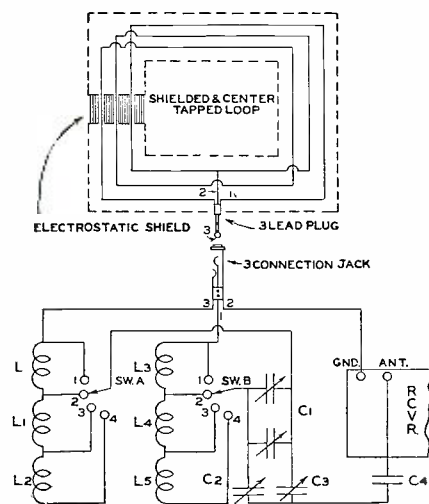

The loop circuit.

C_1 —820 mfd., Meissner type 15116
 C_2, C_3 —3.30 mfd. trimmer
 C_4 —0.0025 mfd. mica
 SWA — SWB —2-gang switch, Meissner, type 19292
 $L, L_1, L_2, L_3, L_4, L_5$ —See text

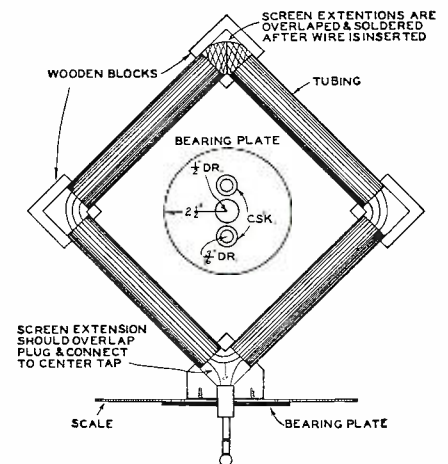

The assembled loop.

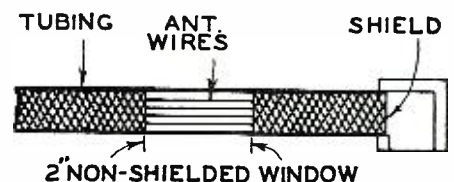

quadrantal errors introduced by the shape of the boat, by the rigging, by the presence of metal objects, bulkheads, wire guys, antenna leads, etc. The procedure is quite similar to that involved in the calibration of the magnetic compass.

Another point which we overlooked in the original story. The radio direction-finder must be frequently checked and re-calibrated, so that it may be relied upon to operate with maximum possible accuracy when occasion for its use arises. (In clear weather, regular radiobeacons are frequently operated so that this checking may be effected.) Compare results or findings effected through radiocompass methods with information obtained through sight, sound, and other direction-finding practices common to navigation—compare and combine *whenever* the opportunity to do just that comes along.

Check your findings through the application of all possible methods under various time and atmospheric conditions, too, so that some sort of correction figures may be tabulated against the possible deviations introduced by such things as "fog effect" and "night effect." Remember that an erroneous bearing might even be effected if a prominence of land extends across the line of that bearing between ship and beacon. Remember that the radio direction-finder is a *safety device* and as such deserves constant attention and checking against correction figures. If the readings are in any question at any time as to accuracy, the instrument becomes worse than useless; it misleads.

Always bear in mind, too, that the loop is bi-directional and that in taking bearings the operator must enter into consideration the 180 degree ambiguity. Generally, it is easy enough to remove this ambiguity where course and relative shore-line position are known—but there is always the *possibility* of error and we can't afford to disregard it.

A last word. Certain readers interested in the receiver have asked the author if there were not some loop circuit with more off-null gain but with accurate balance and a sharp no-signal still obtainable on the null. Work is now progressing on several experimental layouts several of which look to be satisfactory in this respect, but final designs are not yet completed and may not be for some months, due to the press of urgency activities. Two methods of *coupling* our straightforward center-tapped loop circuit to the receiver proper might be mentioned here, however, for what they may be worth to readers interested in working out practical applications in either or both directions.

One method might be *tube coupling* between loop and antenna-coil input to the receiver—the end leads of the loop each looking into the signal grid of a low drain 6S7G or some such tube, plates for the two necessary tubes par-

(Continued on page 56)

"REMOTES"

This is the Reader's Column; where he can express his opinions, and where he can find all corrections.

Gentlemen:

May I add my "say so" to the argument between Messrs. Bradley and Rider? In the first place, the editorial comment that both systems have their merits is about as sensible a remark as could be made on the subject. Score One for the editor! However, I prefer to side with Mr. Bradley. There's a man after my own heart. He says that it's "customer impression" that makes him walk in with a few tools, a couple of tubes, and a volt-ohmmeter. In the next breath he as much as admits he's as lazy as I am when he refuses to lug eighty-odd pounds of test equipment into the customer's house. Mr. Bradley we can easily see is no dumb bunny and has no intention of becoming a truck horse for test equipment.

On the other hand, Mr. Rider, no doubt, has some very good ideas, but it appears to our weary eyes that he is trying to sell us a book. We admit that if we wrote a book we too would try to sell it. This, of course, shows that there are no slurs cast on Mr. Rider for his super salesmanship, it's just that most of us servicemen already have a book. In fact I have just spent twenty or so minutes of searching and what do I dig up but "Servicing Receivers by Means of Resistance Measurement," by John F. Rider. Therein I find something that amuses me no little as this little "treatise" published in 1932 starts off by saying a lot of words to the effect that "modern testing" of "modern receivers," which it seems no longer use "the simple circuits" of yesterday, necessitate a "Modern method" and "quack, quack, quack." Anyway, he uses the same ideas in trying to put across his "signal tracing." Modern complicated circuits? I'd rather work on one of them than one of the "dusies" of a few years ago. Especially some of the babies that took an X-Ray eye to find the parts. Maybe in another seven years Mr. Rider will think up another idea and write another book. Wish to wager?

Mr. Bradley is no little smart when he remarks that he drops that occasional "lily" off his bench into the lap of the poor, unsuspecting distributor. I've done that, too. I thought I was just lazy but maybe that's the genius cropping up in Mr. Bradley and me.

I do 99 44/100% of my testing with a midget volt-ohmmeter that set me back the grand sum of \$11.50. Of course, I've got a portable tube checker that, by turning a few knobs and pushing a couple of buttons, tells all the inner secrets of those glorified Christmas-tree bulbs from water on the brain to spots before the eyes. I park it on the bench and once in a while plug in a tube that I suspect isn't up to par. Particularly those that I don't feel I can reassemble to the customer's satisfaction after I've burrowed inside looking to see if it has any bad teeth! This gadget also has a slightly better volt-ohmmeter that comes in handy after I get a chassis into my sanction sanctorium. As for an oscilloscope, Lee Ward has the best

idea yet in using it as a window display.

Experience is the thing that most often rings the bell [*Thanx for the plug. Ed.*] Especially the one on the cash register. Either personal experience or service notes such as Sylvania publishes or Ghirardi's "Case Histories" such as you are now publishing each month are of greater value than trick service methods. I strongly suspect that long after Mr. Rider writes still another book, "Tester" Bradley and I will both be still doing business the same old way at the same old stand. That is, providing one of us doesn't decide to write a book, too.

May I suggest that you give Mr. Rider and Mr. Bradley a couple of "jimmied" sets and let them fight it out by actual trouble shooting. That ought to be the battle of the century. . . .

(Sgd.) Alex Morton, Jr.,
3028 Biscayne Blvd.,
Miami, Florida.

Dear Sir:

Probably nothing this magazine has ever published will cause so much comment as the articles in the January issue by Messrs. John Rider and Tester Bradley. On the slightest provocation, young armies could be raised in defense of each system. However, there are still service-men, and good ones, too, who are sitting back wondering what it is all about and how they can improve their testing technique.

In our humble opinion, both Mr. Rider and Mr. Bradley leaned over backwards on the demerits of the other fellow, and both failed to produce some of their highly touted technique.

To begin with, we do not like the idea of classifying radio service into "Signal Tracing" and "Catch as Catch Can." Long before Signal Tracing was heard of, many good radio men had a definite system of servicing that was quite comparable to Signal Tracing. Lots and lots of servicemen can trace a signal through a radio with a signal generator with results quite comparable to that obtained with the modern Signal Tracer.

On the face of both articles, the unbiased serviceman is apt to get the opinion that Mr. Rider is acting the role of high pressure salesman, while Mr. Bradley might be looked upon as a stubborn old fossil who is operating on the lower portion of his curve.

Mr. Rider might be criticized for taking the attitude that Signal Tracing is the whole show, instead of only a part of radio testing. After listening to one of Mr. Rider's four-hour tirades on Signal Tracing, one radio man remarked mockingly, "Gee, I don't see how we ever got along 15 years without it." Another remarked, "I'm going to call my boy and tell him to throw all my old equipment out the back door, because I'm coming home with a new signal tracer."

On the other hand, if any man with the experience and knowledge of radio that the "Tester" must possess, does not

(Continued on page 52)

A REVERSIBLE V. T. V. M.

by **D. H. PREWITT**
Artesia, California

A neat general measuring instrument for the serviceman. It is a big time-saver not to have to reverse the prod polarity.

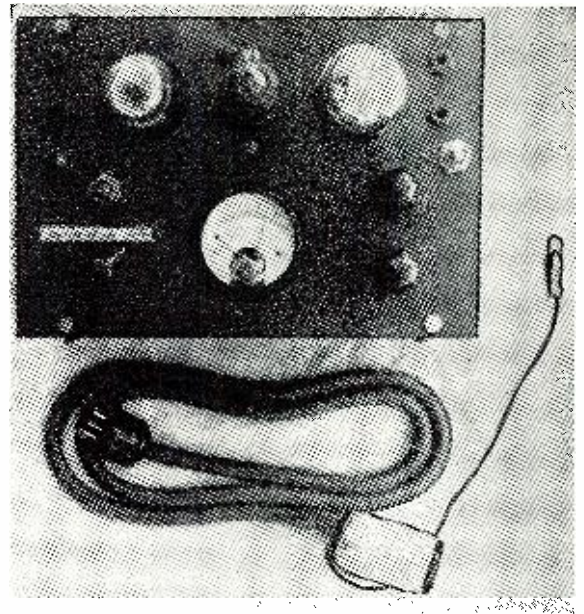

The panel of the reversible V.T.V.M.

MOST vacuum tube voltmeters except those with a zero center scale meter work very well as long as the ground of the voltmeter and the ground of the source of voltage to be measured can be connected together. That is, when a positive voltage with negative ground is measured. But when, with polarity reversed, a negative voltage with positive ground is measured, the hot lead going to the grid of the input tube in the vacuum tube voltmeter must be connected to the ground of the voltage source and all sorts of puzzling phenomena occur. If there is any resistance between this source voltage and the vacuum tube voltmeter a voltage drop apparently occurs in this resistance and an accurate reading is impossible.

This resistance merely emphasizes the trouble however. The trouble is still likely to crop up at any time even if there is no apparent series resistance.

One way to get around this trouble is to use a d.c. meter, with its zero reading in the center of the scale, in the vacuum tube voltmeter. In this direct reading type of meter the ground can always be connected to the ground of the voltage source because the meter is free to move upscale or downscale in response to a positive or

negative voltage. The writer however prefers a slide-back meter because its accuracy depends only on the accuracy of the d.c. meter used and there is no calibrating to be done.

After trying vainly to get a reading with an ordinary slide-back vacuum tube voltmeter under the above circumstances the writer evolved an instrument that apparently solves the difficulty. In this meter the chassis or ground always is hooked to the ground of the voltage to be measured and the hot side, or grid of the meter, is hooked to the hot side of the voltage or that side which is most remote from ground. By means of a switching system a potentiometer hooked across the bleeder of the power supply can have its terminals reversed and thus the voltage between cathode and ground of the 6J7 input tube can be varied in a positive or negative direction to provide

the measured slide-back voltage which counter-balances the applied voltage to be measured.

This instrument has a four foot shielded rubber-covered extension cord so that the 6J7 tube can be plugged in at one end and the other end of the cord plugged into the 6J7 socket. By this means the 6J7 can be used in its regular socket or it can be extended four feet and used "goose-neck" fashion.

(Continued on page 54)

EXTENSION FOR 6J7 TUBE

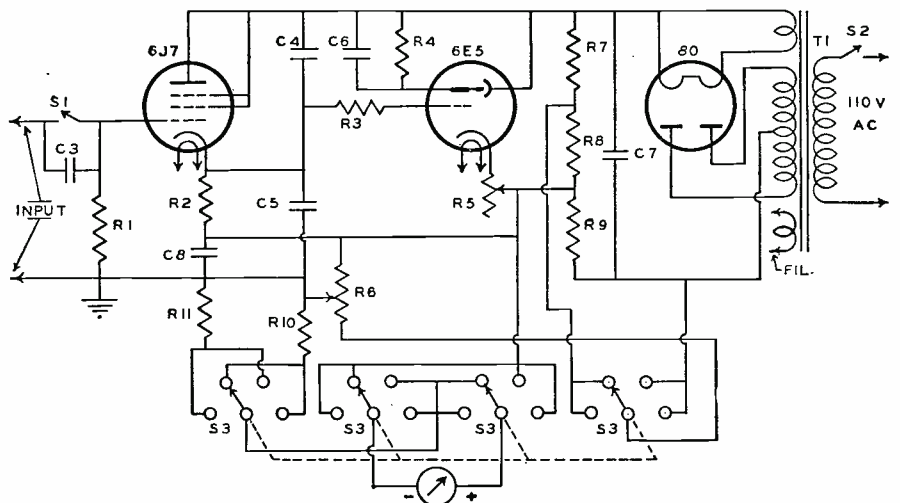
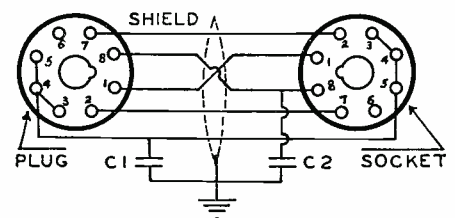

- R₁—3 megohms, 1/2 w. IRC
- R₂—2 megohms, 1/2 w. IRC
- R₃—100,000 ohms, 1/2 w. IRC
- R₄—1 megohm, 1/2 w. IRC
- R₅—10,000 ohm pot. Mallory
- R₆—10,000 ohm wire-wound pot. Mallory
- R₇—10,000 ohms, 10 w. Ohmite
- R₈—5,000 ohms, 10 w. Ohmite
- R₉—3,000 ohms, 10 w. Ohmite
- R₁₀—10,000 ohm precision, 1% IRC
- R₁₁—1 meg. precision, 1% IRC

- SW₁—SPST toggle switch. Arrow
- SW₂—SPST toggle switch. Arrow
- SW₃—4 pole-4 position switch.
- C₁, C₂—0.001 mf. mica. Aerovox
- C₃, C₄, C₅, C₆—1 mf. 600 v. Aerovox
- C₇—16 mf. 450 v. electro. Aerovox
- C₈—4 mf. 200 v. paper. Aerovox

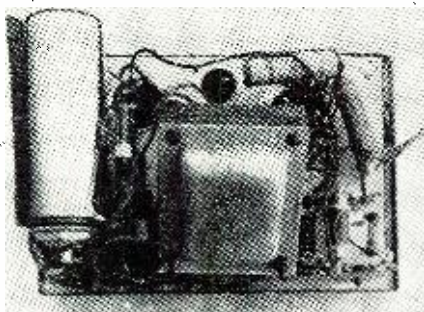

Behind the panel of the V.T.V.M.

\$ Serviceman's Money Page \$

A NEW SERVICE TO READERS

THIS month the Money Page is taken up with some ideas on how to make temporary repairs, even in the home. The most lucrative jobs the serviceman can get are those directly before a National Event to which the prospective customer must listen. Then it is that he calls the serviceman and will pay almost anything within reason to have his radio working perfectly, that very night.

To cash in on such a situation, it is best to make a repair job not only as rapidly as possible,

but to make it at once without dragging the chassis back to the shop. Herewith a few ideas how to do just that.

Protect yourself on the price. Here is an easy way to do it. Charge the customer the same price as you would for a complete replacement job. Explain that you are making a temporary adjustment, and that a replacement must be made since your repair is only so that the customer can listen for that night. Offer to call for the set on the morrow and

do the replacement. If you do not get the replacement price when making the temporary repair, then the customer may leave the temporary job in and never have the real work done. The charge for those temporary jobs which are never finally fixed is a fair profit to you. Since the repair job should be done as soon as possible after the temporary repair, it is best to put a time limit within which the final repair will be made. Always allow the customer a little time.

by CHARLES R. LEUTZ

Today, replacement part manufacturers have greatly simplified radio servicing, by making generally available, a large number of useful universal parts. The well equipped radio technician is therefore prepared to quickly repair any number of different defects by drawing from a supply of a relatively small number of replacement parts. One example is the various oscillator and r.f. transformers (ferro-cart core) which can be adjusted to the desired inductance value during alignment operations.

On the other hand there are times when a suitable replacement part may not be immediately available or even may take considerable time to order and secure. This is particularly true in the case of service work in rural or foreign locations. Under these circumstances it is well to be familiar with possible alterations, made with miscellaneous resistors and condensers principally, that will provide temporary service while the exact necessary parts are being secured.

The drawings accompanying this article illustrate the different common circuit defects encountered, the defect in each case being indicated by a circled X. A discussion on these will be taken up in their numerical order.

1. Antenna Transformer, open primary. A load resistor is connected from antenna to ground. For the broadcast band a value of 10,000 to 20,000 ohms is satisfactory. A mica coupling condenser of about .0001 mf. is connected from the antenna to

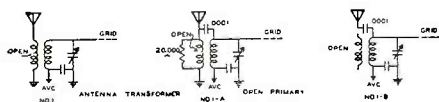

the grid side of the secondary winding, this is shown in 1 (a). An alternative method is shown in 1 (b) wherein the antenna is connected through a .0001 mf. series condenser to the grid terminal of the secondary winding. The antenna circuit is completed through the AVC by-pass condenser to ground.

2. Antenna Transformer, Secondary Open. The primary winding is used as the antenna coupling inductance. A .0001 mf. condenser couples the antenna to the first r.f. grid. A grid leak of about 1/4 megohm

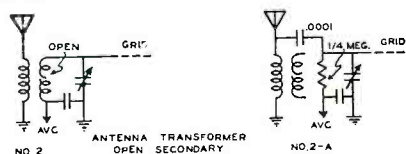

replaces the transformer secondary and enables supplying AVC to the first r.f. grid as before. The tuning condenser is best disconnected.

3. Direct R-F Transformer, Open Primary. One solution is shown in 3 (a) wherein a plate coupling resistor is shunted across the open primary winding. The plate output is coupled to the next grid by a .0001 mf. mica condenser. An alternative is shown in 3 (b) wherein a choke is used in place of a coupling resistor. The resistor method

is perfectly satisfactory for the broadcast

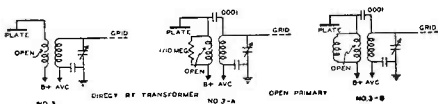

band or lower frequencies. Chokes are preferable for short wave bands.

4. Direct R-F Transformer, Open Secondary. The primary remains as the plate coupling inductance. The output is coupled to the following grid by a .0001 mf. mica

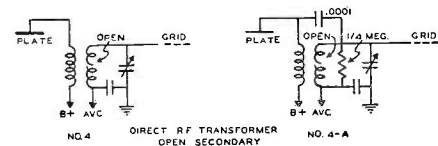

condenser. A grid leak of about 1/4 megohm is inserted as shown to apply the AVC. The tuning condenser is best left disconnected.

5. Intermediate R-F Transformer, Open Primary. The solution is similar to that for a direct r.f. unit, calling for a plate coupling

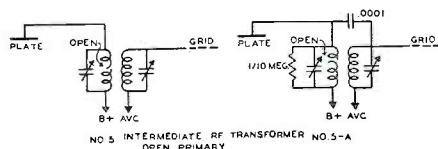

resistor and .0001 mf. mica coupling condenser. The trimmer condenser across the open primary should be disconnected if it can be conveniently done.

6. Intermediate R-F Transformer, Open Secondary. The alterations are practically the same as 4 (a) but the trimmer con-

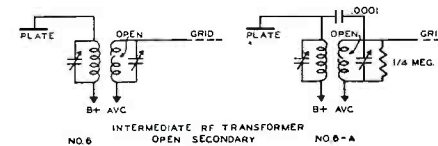

denser across the grid leak should be disconnected, if convenient to do so.

7. Audio Transformer, Open Primary. The first solution is shown in (a) wherein a plate resistor of about 50,000 ohms is used and the plate output coupled to the following grid with a paper condenser of .05 mf. or larger. Another solution is shown in (b) by using the transformer secondary as the

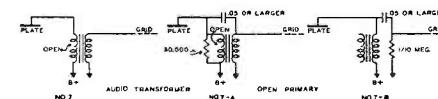
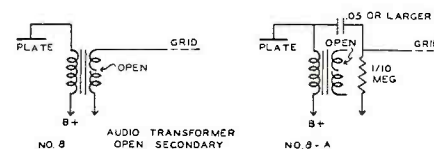

plate coupling unit and adding a grid leak. This latter method is only possible where the plate current involved is small and the secondary winding capable of handling same.

8. Audio Transformer, Open Secondary.

By using the primary winding as an impedance, the stage is changed to impedance-coupling instead of transformer coupling. The change is completed by adding a coupling condenser (paper) of .05 mf. or larger and the grid leak shown. The resistor values



indicated above are average for the regular run of tubes and will have to be altered for the midget tubes or for power tubes. The necessary values are given in standard tube manuals.

9. Input Push Pull Transformer, Open Primary (or open secondary). By changing the single triode to a twin triode of either low, medium or high mu, the stage

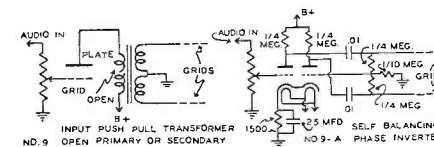

can be changed to a self-balancing phase inverter. The correct values are shown in (a).

10. Input Push Pull Transformer, One Secondary Open. Temporary service can be secured by operating the two output tubes in parallel as shown in (a). The power out-

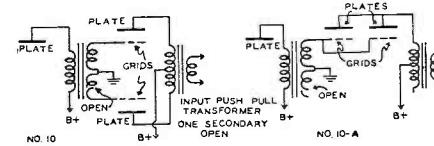

put is only slightly reduced, but the advantages of push pull operation are lost.

11. Interstage Push Pull Transformer, Defective. The push pull tubes are readily

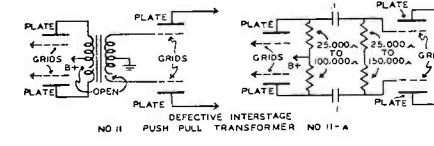

changed to resistance coupled operation as shown in (a).

12. Output Transformer, Open Secondary. Fair results can be obtained by us-

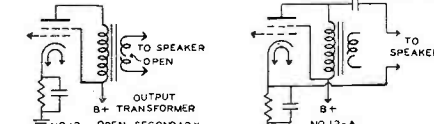

(Continued on page 49)

SEVENTY-TWO CASE HISTORIES

by ALFRED A. GHIRARDI, B.S., E.E.

Author of "The Radio Physics Course," "Modern Radio Servicing"; member Radio Servicemen of America, New York Electrical Society, Institute of Radio Engineers.

GENERAL ELECTRIC A-88

Same Case Histories as those listed for General Electric A-86 receiver

GENERAL ELECTRIC A-90

(Uses same chassis as RCA M-30 receiver.) See the Case Histories listed for RCA M-30 receiver

GENERAL ELECTRIC A-125

- Inoperative ... 1) no voltage on '6L7 screen. Replace "shorted" 0.05-mfd. screen by-pass condenser
2) no '6L7 plate voltage. Replace "shorted" 0.05-mfd. plate-return by-pass condenser and 2000-ohm plate-return isolation resistor
- Inoperative ... 1) short-circuited type '6K7 tube in AVC circuit
- Inoperative ... 1) "leaky", or "shorted" 0.08-mfd. tone-control condenser
- Sensitivity control inoperative in any position 1) check the position of the '6A8 bias resistor within the "sentry box". The lead of this carbon resistor (soldered to a lug on the terminal strip) often "grounds" to the case of the long-wave band "padding" condenser
- No DX reception 1) short-circuited "permaliner" i-f trimmer condenser. Test each circuit in chassis separately with oscillator to trace this trouble
- Fading ... 1) "flash" either of the i-f primary trimmers to chassis with a screwdriver. Trouble "shorting" and "leaking" in the air-tuned i-f trimmer condensers ("Permaliners") employed. Replace these condensers if necessary
- High sensitivity 1) "shorted" 0.05-mfd. 200-volt screen-grid by-pass condenser of the 6K7 AVC amplifier stage. Replace with a unit of higher voltage rating
- Oscillation ... 1) replace the grid resistor (R-11) in the oscillator circuit with one of 50,000 ohms
2) place small, soft rubber washers on the speaker mounting bolts both in front and in back of the speaker. A metal washer should be placed over the rear one before the nut is replaced
- Noisy reception 1) tighten the bolts fastening i-f shield cans to chassis. Placing lock-washers under bolts will avoid future trouble
- Poor tone on "E" band (18-40-mc) 1) no fault of receiver. Due to inadvertent frequency-modulation of transmitter
- Tuning dial off 1) defective type '6L7 tube calibration. (Even though it tests O.K.)
- Tuning meter functions erratically or not at all 2) check the 0.05-mfd. condenser (C-61) between G-2 and G-3 of the 6K7 AVC i-f amplifier for a "shorted" condition. When replacing, also check 5,000-ohm resistor (R-29) as this resistor overheats when the condenser shorts
- Poor tone, poor short-wave reception 3) after the trouble has been located and corrected, recalibrate or reset the pointer

GENERAL ELECTRIC A-205, A-208

- Tuning dial off 1) see the Case History for this same trouble listed for General Electric A-125 receiver
- Tuning meter functions erratically or not at all 2) check the 0.05-mfd. condenser (C-61) between G-2 and G-3 of the 6K7 AVC i-f amplifier for a "shorted" condition. When replacing, also check 5,000-ohm resistor (R-29) as this resistor overheats when the condenser shorts
- Poor tone, poor short-wave reception 3) after the trouble has been located and corrected, recalibrate or reset the pointer
- Distortion ... 1) improper phasing of dual speakers. Reverse connections on one of voice coils
- Speaker rattle ... 1) unevenly tightened speaker mounting bolts. Speaker cone warps as a result of an excessively tightened bolt, causing the voice coil to be thrown off center

GENERAL ELECTRIC B-1

(Uses same chassis as RCA Radiola 21 receiver.) See the Case Histories listed for RCA Radiola 21 receiver

GENERAL ELECTRIC B-2

(Uses same chassis as RCA Radiola 22 receiver.) See the Case Histories listed for RCA Radiola 22 receiver

GENERAL ELECTRIC B-40 AUTO RADIO

(Uses same chassis as RCA M-34 Auto Radio receiver.) See the Case Histories listed for RCA M-34 receiver

GENERAL ELECTRIC BX-41

(Uses same chassis as RCA R-17-M receiver.) See the Case Histories listed for RCA R-17-M receiver

GENERAL ELECTRIC B-86

(Uses same chassis as RCA 241-B receiver.) See the Case Histories listed for RCA 241-B receiver

GENERAL ELECTRIC C-14 AUTO RADIO

Inoperative with 1) open-circuited 0.02-mfd. condenser (C-16) connected from the diode section of the type '6B7 tube through the variable arm of the volume control to the control grid of the triode section of the same tube. Replace with new unit

GENERAL ELECTRIC C-41 AUTO RADIO

Regeneration in 1) reverse input or output leads in interstage transformer, thereby changing the phase of the transformer and preventing coupling with some other part in the receiver

GENERAL ELECTRIC C-60 AUTO RADIO

Noise-level ... 1) if the receiver has leads brought out only to five lugs on the antenna coil (one unused, connect grid lead from variable condenser to vacant lug instead of original connection, so that the full secondary winding is used

GENERAL ELECTRIC C-61 AUTO RADIO

Periodic oscillation 1) faulty type '6D6 tube
2) faulty type '41 tube
Motorboating 3) faulty 0.5-mfd. screen by-pass condensers. Replace with condensers of higher voltage rating

GENERAL ELECTRIC C-67 AUTO RADIO

(Uses same chassis as RCA M-104 receiver.) See the Case Histories listed for the RCA-223 receiver

GENERAL ELECTRIC D-50 AUTO RADIO

(Uses same chassis as RCA M-101 receiver.) See the Case Histories listed for the RCA M-101 receiver

GENERAL ELECTRIC D-51, D-52 AUTO RADIOS

(Uses same chassis as RCA M-104 receiver.) See the Case Histories listed for the RCA M-104 receiver

GENERAL ELECTRIC D-72 AUTO RADIO

(Uses same chassis as RCA M-109 receiver.) See the Case Histories listed for the RCA M-109 receiver

GENERAL ELECTRIC E-51

Inoperative ... 1) check for plate prong of output tube "shorting" to chassis
2) the 0.01-mfd. condenser (TC-26) connected between the diode plate and B minus should be shunted by another 0.1-mfd. condenser

GENERAL ELECTRIC E-71

Inoperative ... 1) check 0.02-mfd. second i-f plate by-pass condenser for a "short"
2) check 2,200-ohm plate dropping resistor by removing second i-f coil shield
3) replace 2,200-ohm second i-f cathode resistor
Weak reception 1) check for "shorted" condenser in 6K7 i-f tube plate return filter
Powers transformer overheats, smokes 1) check for "shorted" condenser in 6K7 i-f tube plate return filter

GENERAL ELECTRIC E-76

Inoperative ... 1) "shorted" 0.01-mfd. 200-volt

on broadcast band

condenser connected to shaft of all-wave switch by green wire. Place with 600-volt unit

GENERAL ELECTRIC E-81, E-86, E-91, E-95, E-101, E-105

- 5Z4 tube goes bad frequently 1) check filament voltage on the 5Z4 tube. If it is much over 5 volts, connect a 10-watt resistor of low resistance value in series with the filament in order to reduce filament voltage to normal value
- Inoperative ... 1) "open" screen-grid section of voltage divider
- Noisy between stations 1) remove the 2,200-ohm cathode resistor of the 6K7 first i-f tube. This resistor is under the chassis. Substitute a 25,000-ohm resistor in its place. Remove the r-f cathode wire running to "ground" on the 6K7 r-f tube socket and connect it to this 10,000-ohm resistor. This will retard the AVC action.
- High noise level ... 1) break cathode connection of the 6K7 first i-f tube and bias it through a 10,000-ohm 1/2-watt resistor. By-pass with a 0.05-mfd. condenser.
- Intermittent reception and "clicking" noise (E-105 receiver) 1) faulty 6L6 power output tube (not usually indicated by tube tester). Replace tube
- Weak reception, 1) faulty 5Z4 rectifier tube. Replace and green 2) check carefully for a defective focussing light bulb, for they are wired in series when set is tuned (E-105 receiver)

Distortion, low volume after 10 minutes of operation (E-81 receiver) 1) if plate voltage of the 6L6 tube drops to about 25 volts check to see if the 6L6 is "shorted" internally to shield. Replace with either a 6L6 or 6L6G tube

Noisy volume control (E-86, E-95, E-105 receivers) 1) before replacing volume control, try replacing 6F3 first a-f tube

GENERAL ELECTRIC E-106

High noise level 1) break cathode connection of 6K7 first i-f tube and bias through a 10,000-ohm 1/2-watt resistor. By-pass with a 0.05-mfd. condenser

GENERAL ELECTRIC E-126, E-129

- Insensitive (E-126 receiver) ... 1) "shorted" 0.05-mfd. by-pass in plate circuit of 6L7 mixer tube
2) burned 2,200-ohm resistor inside first i-f transformer before replacing volume control, try replacing 6C5 first a-f tube
- Noisy volume control (E-126 receiver) 1) stretch spring on tone arm slightly to improve ratchet action. Adjust set-screw on record lift lever
- Record changer (E-129 receiver) 1) clean contacts of the "Silent Tuning" switch, and spread a thin layer of solder on each outer blade of the switch to stiffen them

GENERAL ELECTRIC E-155

See also Case Histories listed for General Electric E-126 receiver

Fuses blow ... 1) faulty 5Z4 rectifier tube

Inoperative ... 1) "open" 50-ohm resistor in one of the two 5Z4 plate circuits. These resistors are secondary high-voltage windings to one of the plates of each 5Z4 rectifier tube. Use 50-ohm 25-watt resistors for replacement.

Pilot light bulbs 1) pull out the speaker plug, remove the chassis. Unsolder the black lead connected to the bank of pilot bulbs, and insert a 1-ohm resistor in series with it to reduce the voltage applied to the pilot light bulbs

(Continued on page 66)

A Simple Signal Tracer

(Continued from page 18)

the efficiency of the coils used. Unless the builder has more than ordinary facilities, and better than average knowledge of coil design, it will generally be a waste of time and money to attempt to construct or improvise coils suitable for use in an instrument of this type. The coils should afford high gain, and approximately constant amplification through each band, if the approximate gain per stage is to be checked with useful results. The coils finally selected for the model shown were made by the Carron Mfg. Company, and are supplied as the T 143 r.f. Assembly, mounted on an interstage shield, completely wired and tested with rotary band switch. These coils are wound and matched to a remarkable degree of accuracy, so that the same frequency ratio is obtained for all bands. This extreme accuracy simplifies the dial calibration exceedingly, as only two scales are required, which will be decimal repeating.

The vacuum-tube voltmeter is of the bridge-balance type, and was designed to allow the use of a standard 0-1 MA meter, balanced for zero setting at mid-scale, and full deflection in opposite directions, when one volt positive or negative is applied to the grid of the 6J5G tube. Since the tube is biased as an amplifier at approximately 2.5 volts, an input of one volt plus or minus is well within the bias limits, and the meter scale will be practically linear, so that the regular divisions on the standard scale may be used with little error. The plate voltage should be rather closely adjusted around 125 to 130 volts, and the 5,000 ohm potentiometer in the power supply voltage divider is the best method of doing this. The tube selected for this service must be as free from gas as possible, on account of the high resistance in the grid circuit.

The multiplier across the input has a total resistance of 12.5 megohms, and was designed to produce standard voltage ranges with stock sizes of resistors. The resistors need not necessarily be of the semi-precision type, but should be of best quality, preferably insulated. It will be found that the majority of resistors of good manufacture, when new, are generally about 10% over their rating, and if the individual resistors in the network are selected with the same percentage of error, the net results will be sufficiently accurate. The six-position switch for this service should be the shorting type, to avoid opening the grid circuit when changing ranges, which would result in slamming the meter pointer off-scale, with possible damage.

The VTVM and multiplier is connected to a two-pole four-throw switch, which provides four services. In the first position the meter is connected to the r.f. filter of the 6H6

detector, in order to measure the r.f. signal picked up and amplified by the instrument. In the second position, the meter is switched to the second section of the 6H6, and also connected to the separate voltmeter connector, through a .5 mf., 600-volt condenser for external a.f. voltage measurements. In the third position, the meter is switched directly to the V.M. connector, and is available for external d.c. measurements up to 500 volts.

The high range may be extended by proper substitution of resistors in the multiplier. In the fourth position, a 1-volt bias cell is connected across the grid circuit of the 6J5G tube to check the calibration of the meter. To make this check, the meter is switched to the d.c. position, using the 1-volt range,

and the pointer set at mid-scale by adjusting the 50,000-ohm control. When the switch is thrown to "Cal", the fourth position, the pointer should swing to the left limit of the scale. If the meter does not read full scale the plate voltage should be increased, the meter re-balanced for zero-setting as before, and the calibration checked again. If the meter swings off-scale, the plate voltage is too high and should be reduced. This refinement may be omitted if desired as it is not often required, but it is a convenience whose value exceeds its very low cost.

When the unit is completed and operating, the builder should be able to pick up several stations in the broadcast band, with a short antenna *(Continued on page 43)*

IT'S RCA FOR UNMATCHED QUALITY... UNBEATABLE LOW PRICES!

A REVOLUTIONARY SPEAKER DEVELOPMENT BY RCA



**New RCA Accordion Edge Speaker
BIG IN PERFORMANCE... SMALL IN SIZE**

Here is a radical step forward in speaker engineering! The new RCA Accordion Edge Speaker provides unheard of travel of the free-edge diaphragm because of bellows action. Its performance will

amaze you. Small size will surprise and please you.

Listed below are some of the features of this new speaker. They prove that *now* a small speaker can be a *quality* speaker.

- * Ultra sensitivity
- * Remarkable frequency characteristics
- * Excellent quality at high or low volume
- * Sealed voice coil
- * Exceptionally smooth response
- * Compact 7½" x 3½"
- * Large Alnico permanent magnet
- * Ideal for new or replacement work
- * 6 ohm voice coil
- * 3 watts average capacity
- * Superior performance at low cost
- * Matching transformer can be added to permit wide variety of matching impedances.

Get in touch with your RCA Commercial Sound Distributor for full details.

Any sound system sounds better equipped with RCA Radio Tubes



Commercial Sound

RCA Mfg. Co., Inc., Camden, N. J. • A Service of Radio Corporation of America

MANUFACTURERS' LITERATURE

A RADIO NEWS READERS' SERVICE

SIMPLIFIED SOUND SYSTEMS. A new 64-page catalog of sound systems was recently issued by *Montgomery Ward & Co.* It illustrates and describes a complete new line of amplifiers for every purpose. It shows how to select a sound system for any hall or installation; what type speakers and how many; what microphone for the particular purpose; how much power needed in the amplifier, etc. With the aid of this catalog anyone is competent to select a system and install it. A free copy can be obtained by writing *Montgomery Ward & Co.*, Chicago. Free. (RADIO NEWS, No. 8-100.)

NEW SYLVANIA RADIO TUBE BASE CHART. A new radio tube base chart is being announced by *Hygrade Sylvania Corporation*, Emporium, Pa., and is now being distributed to dealers and servicemen through *Sylvania* jobbers. Several revisions have been made and a new style of layout has been adopted. The new chart, although reduced in size by showing base views in a smaller size, has an increased number of base views and covers all tube types. For the 376 types extant, there are shown 118 views and a complete index and cross index for all tubes and base views.

Servicemen may write direct to the factory at Emporium, Pa., for their copy or they may be secured from the *Sylvania* jobber. (RADIO NEWS, No. 8-101.)

CORNELL-DUBILIER ELECTRIC BULLETIN. The increasing use of fluorescent lights for better interior illumination and color effects is bringing wider recognition of the need for power factor correction in such circuits. Operating at a power factor of only 50% as they do, fluorescent lamps impose twice the current drain on the line that their wattage ratings indicate.

An analysis of this condition with a discussion of simple corrective means is given in *Bulletin No. 190A* just issued by the *Cornell-Dubilier Electric Corp.*, South Plainfield, N. J., entitled "Capacitors for Power Factor Correction of Fluorescent Lamps." This bulletin presents typical fluorescent lamp circuits with suggested connections for correction capacitors, and tables showing the capacitor values required for different degrees of correction. It also indicates the requirements desirable in capacitors to be used in this service and includes descriptive material and prices on the comprehensive variety of Cornell-Dubilier capacitors for fluorescent lamp applications. Free. (RADIO NEWS, No. 8-102.)

RADIO BUILDERS HANDBOOK. A new thoroughly revised edition of the *Allied Radio Builder's Handbook* has just been released by the *Allied Radio Corporation*, Chicago, Illinois. This edition has been enlarged to include new diagrams and kits with complete data, plans, and parts lists for the construction of a wide variety of receivers, and transmitter, amplifier, and photo cell equipment. The text is fully illustrated with tables, charts, diagrams and pictures. Size: 8½ x 11". 36 pages. Offered at 10c to cover mailing and handling. Write to *Allied Radio Corporation*, 833 W. Jackson Blvd., Chicago, Illinois. (RADIO NEWS, No. 8-103.)

MOMSEN - DUNNEGAN - RYAN COMPANY CATALOG. A list price catalog for the radio trade with manufacturer's index and order blanks is announced by *Momsen - DunneGAN - Ryan Co.* of El Paso, Texas. A comprehensive listing of hundreds of parts in an attractive three colored cover and compiled with minute care after weeks of preparation makes this buying guide invaluable. Dealers will increase sales by using this catalog as a silent salesman, and will find it very helpful as a reference book. Free. (RADIO NEWS, No. 8-104.)

RADIO TUBE MERCHANDISING CO. CATALOG. The radio trade in the surrounding territories of Michigan is now receiving by mail a recent catalog published by *Radio Tube Merchandising*, 508 Clifford Street, Flint, Michigan. If you haven't received your copy of this 180 page catalog, drop them a card. It is a very handy book to have around whether you contemplate purchasing any radio parts or not. One outstanding feature is that the catalogs are punched so that you can attach it to your counter or desk with a string and be sure that nobody will walk off with it. Of course, it is always within easy reach. Free. (RADIO NEWS, No. 8-105.)

SHALLCROSS BULLETIN No. 122-Y. This new bulletin is devoted to a detailed discussion of the electrical and mechanical specifications of the various standard and special *Shallcross* non-inductive, wire-wound, accurate resistors. These resistors are designed for manufacturers and users of electrical apparatus. The normal accuracy of the standard stock resistors is plus or minus 1%. However, it is common practice to calibrate resistors to an accuracy of 0.5, 0.25 and 0.1 of 1%. Manufacturing such a large variety of resistors to cover a range resistance from .01 to 10,000,000 ohms

requires employing various alloys such as manganin, copper-nickel (Advance), nickel chromium (Nichrome), copper, iron, nickel and other special resistance alloys. Shallcross resistors are normally wound non-inductively, but can be wound inductively, when specified. Free. (RADIO NEWS, No. 8-106.)

HARDWICK HINDLE CATALOG No. 40. *Resistors and Rheostats*, a new catalog published by *Hardwick-Hindle Inc.*, Newark, N. J., is now ready for distribution to the trade. All of the items listed are carried in stock and are ready for immediate delivery. This concern manufactures Vitreous-enameled rheostats in many sizes, among them being units with 10 and 25 watt ratings. They are available in resistance values from 1 to 2,500 ohms in the 10 watt size, and from 1 to 5,000 ohms in the 25 watt size. Resistance wire is wound upon a heat-resisting phenolic strip. The wound strip is rigidly attached to a refractory base. Contact arm of beryllium-copper gives uniform pressure, smooth action and long life. The ratings listed in the catalog are for application in free-air. When units are enclosed values should be reduced about 50%. Free. (RADIO NEWS, No. 8-107.)

TERMINAL PUBLIC ADDRESS CATALOG. A new catalog has just been released by the *Terminal Radio Corporation*, 80 Cortland St., N. Y. C., and contains a listing of complete sound systems, accessories, amplifiers, etc. Among the complete systems listed are those having the following ratings—an 8-10 watt system, portable systems, 20 watt systems in both portable and permanent types, a 20 watt outdoor system, a 30-40 watt unit for auditoriums, etc. A full line of Microphones, Speakers, Pickups, Phono-Motors, Microphone Stands, Cable Connectors, Microphones, Projectors, Baffles, and Record-Players. The complete line of *Thordarson* Amplifiers is listed, including the new 10 Watt Studio Amplifier that will find many applications in Broadcast, and high-fidelity work. Copy available from the *Terminal Radio Corp.* Free. (RADIO NEWS, No. 8-108.)

SOLAR CATALOGS Nos. QC and RC-10. The first bulletin describes the new *Solar* condenser *Quick-Check*, an instrument that spots good and bad condensers quick as a wink. This is done under actual operating conditions or separately. It measures capacity, and indicates power-factor. In-

(Continued on page 54)

A Simple Signal Tracer
(Continued from page 41)

connected directly to the grid of the first r.f. tube through a .0005 condenser, and the instrument will be ready for calibration of the dial. A dial may be made, similar to the one shown, from a four-inch disc of heavy Bristol board. The double-end pointer knob was made by cementing a 4" length of *Amphenol* #912 strip ($\frac{3}{4}$ " wide by $\frac{1}{16}$ " thick) to an ordinary finger grip knob. The calibration of the dial is easily accomplished, as only a signal generator is required, which should be checked for accuracy by zero-beating against the signals of broadcast stations. The trimmers of the coil assembly should be peaked with minimum capacity, and the scale for the B.C. band marked on the dial, which should cover the range from 1700 to 550 kc. with a little to spare. The harmonics of b.c. frequencies may then be used to calibrate the second scale from 1,700 to 5,000 kc. If the work is done with reasonable care, the calibration of these two scales will serve for all bands, as follows:

- Scale A: 55-170 kc.
550-1700 kc.
5500-17000 kc.
- Scale B: 170-500 kc.
1700-5000 kc.

The sample dial shown may be used as a guide to the approximate position of the calibration points, provided the *Carron* 442 mmf., condenser (B 1080) is used, or one of similar characteristics. The best accuracy will be obtained if the dial is calibrated from frequencies obtained by zero-beating against signals of known frequency.

To operate as a signal tracer, the voltmeter is switched to the r.f. position, 5-volt range, and balanced at center-scale. The attenuator is set in the "1" position with the r.f. gain control full on. An r.f. signal is applied to the antenna and ground connections of the receiver to be checked, and the r.f. test prod applied to each stage in turn, beginning with the antenna coil; the dial of the tracer being set at the correct frequency, and the attenuator and voltmeter range adjusted as required. A good signal generator is the best source of r.f. voltage for such testing, as the operator will have a choice of test frequencies, and signal strength control.

As a guide to the results to be expected from stage-by-stage testing, the following table is supplied:

- Average Gain Per Stage*
- Antenna Transformer 2-5.
 - Ant. Transformer (auto) 10-30.
 - R.F. Stage 5-30.
 - Mixer Stage 20-40.
 - Single I.F. Stage 40-150
 - Two I.F. Stages 10-25 each.
 - Loss at Diode Det. $1\frac{1}{2}$:1-3:1.
- Average Gain, A.F. Amplifiers*
- 6C8—20-30.
 - 6F5—40-50.
 - 6Q7—30-40.
 - 75—40-50.

Low mu triodes: 3-10.
Average Gain: Power tubes—Pen-
todes, 10-15; Triodes, 2-5.

It should be understood that the values of r.f. and i.f. gain listed, are for a condition of no a.v.c.

When the voltmeter is switched from the d.c. position to the r.f. or a.f. positions, it will be noticed that the meter will read about .2 volts on the 1-volt range. This is due to the idling current, or contact potential of the 6H6, and may be disposed of in two ways. The 6H6 may be biased by returning the cathode to a positive tap on the bleeder, and the idling current bucked out. However, this introduces an equivalent error in the calibration, and it is a simpler and more satisfactory

method to re-balance the meter, by adjusting the balancing control. The effect is not serious, as most r.f. measurements should be made on the higher ranges, not to exceed 50 volts. When r.f. signal voltages are strong enough to produce more than 50 volts reading at the meter, the attenuator should be used, as the second r.f. tube may be overloaded, causing gross errors.

A word of caution to the optimistic may be in order. It is clear that the instrument is in no sense a "junk box special," and will reflect directly the quality of the parts and work put into it. It cannot be carelessly thrown together, as the opportunities for "bugs" are plentiful. The following minor de-

Two New Instruments—At Record Breaking Low Prices



**THE NEW MODEL 1230
SIGNAL
GENERATOR
WITH
FIVE STEPS
OF
SINE-WAVE AUDIO**

SPECIFICATIONS
RADIO FREQUENCIES from 100 K. C. to 90 Megacycles in 7 bands by front panel switch manipulation. All direct reading and accurate to within 1% on I.F. and Broadcast bands, 2% on higher frequencies. The R.F. is obtainable separately or modulated by any one of the five Audio Frequencies.
AUDIO FREQUENCIES: 5 steps of SINE-WAVE audio 200, 400, 1000, 5000 and 7500 cycles WITH OUTPUT OF OVER 1 VOLT. Any one of the above frequencies obtainable separately for servicing P.A., hard-of-hearing aids, etc.
ATTENUATOR: Late design, full-range attenuator used for controlling either the pure R.F. or modulated R.F.

CIRCUIT: The Model 1230 employs an improved electron coupled oscillator circuit for the R.F., affording positive protection against frequency drift and a Hartley oscillator circuit for the A.F. section.
DIAL MANIPULATION: Large $5\frac{1}{2}$ " dial etched directly on front panel, using a new mechanically perfected drive for perfect control.
APPEARANCE: The front panel is etched by a recently perfected process which results in a life-long attractive finish and the instrument comes housed in a streamlined shielded cabinet.
CURRENT SOURCE: The Model 1230 operates on 90 to 130 Volts A.C. or D.C. any frequency.

The Model 1230 comes complete with tubes, shielded cables, moulded carrying handle and instructions. Size 14" x 6" x 11". Shipping weight 15 pounds. ONLY **\$12⁸⁵**

**THE NEW MODEL 1220
World's Lowest Priced
5,000 OHMS
PER VOLTER!**

Extremely valuable because of its high sensitivity, the Model 1220 is an all-purpose tester that permits resistance measurements up to 3 Megohms, with only a 3 V. self-contained flashlight battery and reads directly down to 0.2 ohm.

- SPECIFICATIONS**
- ★ 6 D.C. Voltage Ranges: 0-3-10-50-250-500-5,000 volts.
 - ★ 3 A.C. Voltage Ranges: 0-15-150-1500 volts.
 - ★ 4 Resistance Ranges: 0-3000 ohms, with 15-ohm center direct reading to 0.2 ohm; foregoing base range multiplied by 10, by 100 and by 1,000, to read up to 3 Meg. with self-contained 3 V. flashlight battery.
 - ★ 4 D.C. Current Ranges: 0-200 microamperes; 0-2-20-200 Milliamperes, using wire-wound shunts.
 - ★ 3 Output Meter Ranges: Same as A.C. Voltage Ranges.
 - ★ 3 Decibel Ranges: From -2 to +58 D.B., based on .006 watt in 500 ohms.
 - ★ Uses full-sized 3" square 0-200 microammeter, with 2% accuracy and finely damped movement, contained in a handsomely-designed, square molded Bakelite case.

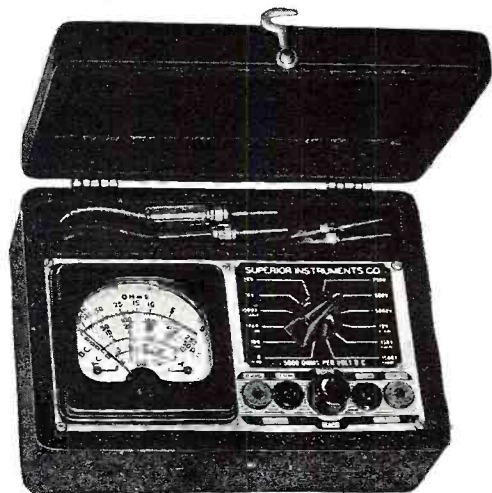

Model 1220 comes complete with cover, self-contained battery, test leads and instructions. ONLY **\$10⁴⁵**

SUPERIOR INSTRUMENTS CO.
136 Liberty St. Dept. RN 8 New York, N. Y.

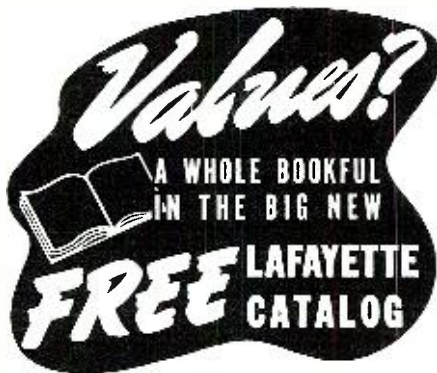

MYSTERY Oscillator with hand microphone

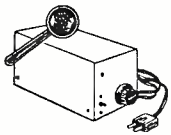

Now — enjoy your record player through your radio without a wired connection! Simply plug in output of crystal pick-up to the oscillator. This "broadcasts" to the radio

which picks up and reproduces the music with all its original tone and brilliance. To conduct a "broadcast" of your own, connect to oscillator the hand mike offered with the complete unit. For 110 volts AC and DC. Complete with tube (12A7) and handmike at this special low price..... **\$2.95**

Complete Battery Kits for Popular Portable Radios



Exact duplicate replacement battery kits for the most popular portable battery radio sets on the market today. Replace the originals exactly; both physically and electrically. Offered at new low prices!

You save on every purchase. Shpg. wt., each kit, 7 lbs.
K20173—KIT "A" SALE PRICE..... \$2.15
K20174—KIT "B" SALE PRICE..... \$2.49
K20175—KIT "C" SALE PRICE..... \$1.75
K20176—KIT "D" ANY ABOVE, SALE PRICE EACH..... \$2.49
K20177—KIT "E" SALE PRICE..... \$1.75

KIT "A" FOR FOLLOWING SETS:
 Emerson CE259; Philco 39, 71T, 72T, 74, 504; Pilot TH11, TH12; RCA 94BP80, 94BT1, 94BP4, 94BP64, 94BP1, 96GA, 94BP66; Zenith 4K400D, L, M, S, Y, 5416.

KIT "B" FOR FOLLOWING SETS:
 Emerson C263, CT275, CX263, CX283, CX284, CX305, DC308, CE265, CE275; Pilot H11, H12; General Electric GB400, HB408.

KIT "C" FOR FOLLOWING SETS:
 General Electric JB515, JB508, HB412; Pilot T1351, T1451, T1452, X1451, X1452; RCA BP55, 56, 85.

KIT "D" FOR FOLLOWING SETS:
 Emerson DF306, DF302, DJ310, DJ311, DJ312, EA338, EA339, EA340, EA357.

KIT "E" FOR FOLLOWING SET:
 Majestic 130.

BUY BY MAIL OR IN PERSON

At one of our 7 convenient stores. Either way you're sure to get better service—greater value.

100 Sixth Ave., New York, N. Y. • 901 W. Jackson Blvd., Chicago, Ill. • 265 Peachtree St., Atlanta, Ga. • 110 Federal St., Boston, Mass. • 24 Central Ave., Newark, N. J.
 542 E. Fordham Rd., Bronx, N. Y. • 90-08 166th St., Jamaica, L. I.

**LAFAYETTE
RADIO**

**RUSH
COUPON
NOW**

DEPT. 2H - 100 SIXTH AVE., NEW YORK, N. Y.

I ENCLOSE \$ RUSH ATTACHED ORDER
 PLEASE RUSH NEW FREE CATALOG No. 80

NAME

ADDRESS

CITY STATE

tails should be of assistance in preventing some mechanical and electrical errors.

If a chassis layout similar to that shown in the photo is used, it will be advisable to use shielded lines from the diode detector to the r.f. and a.f. positions of the voltmeter function switch. The line from the diode to the volume control and back to the first a.f. amplifier should also be shielded. The shielding of these lines should be soldered to the chassis in two or three places. All controls were installed, and wiring done, below the chassis, which was shifted upward on the panel to provide the 4½" of space necessary for the coil assembly. Since the stock 10" x 14" chassis is only 3" deep, supports for the back were provided by tapping the folded lip, and using #10/32 machine screws, with lock nuts, as adjustable legs. In order to accommodate the double row of controls, a wide panel is required, and a *Par-Metal* cabinet, 9" x 15" x 10¾", was selected for this service. The black crackle finish on this cabinet was found to be of more than usual durability, as the panel was subjected to a considerable amount of rough handling without marring the finish. As an unusual feature of added value, it was discovered that the calibrations for the various controls could be stamped directly on the panel, without the enamel chipping off around the figures or letters.

The 5" speaker is about the largest size that can be conveniently installed in this cabinet, and has a 1,000-ohm field, which is also used as a filter choke in the power supply. The ordinary small speaker customarily sold at low prices will not be suitable for this service, as the field coil is generally wound for 35 ma. current or less. Since the total drain of the unit is around 60 ma., a speaker of better construction will be required, similar to the *Utah R-510* speaker shown. A somewhat better but more expensive alternative would be the use of a 70 ma. filter choke, and a p.m. speaker.

If trouble is experienced with oscillation or regeneration in the r.f. amplifier it will be necessary to add more shielding around the coil assembly. In the model shown it was necessary to add a shield, about 4½" x 6", directly underneath the coils, as the bottom flange of the interstage shield did not make contact with the bottom of the cabinet. The interstage shield is fastened to the chassis with spade bolts, and should be bonded at each end, by soldering short lengths of copper braid to the shield and chassis. Regeneration should be reduced as much as possible, as it will cause uneven gain in the band affected. If the cause of such regeneration cannot be found and eliminated, the user should make a comparative test to determine the difference in gain. The builder should bear in mind, that imperfectly grounded shielding may act as a coupling between high-frequency stages rather than as a shield.

The remainder of the components in the instrument are so common as to require little comment. The controls, switches and resistors may be any reliable make the builder prefers. The resistors in the bleeder of the power supply carry around 12 ma., and should therefore be at least 2 watts rating.

The instrument is capable of many other applications besides the checking of stage-by-stage operation, but it is not within the scope of the present article to describe in detail all the tests that may be made. The man experienced in dynamic testing, or vacuum-tube voltmeter technique, will not require this information; and to cover the subject adequately for those of limited experience would require more space than is available for this purpose, and would more properly form the subject matter for a book. Such a book has already been written by John F. Rider, and is to be recommended to those whose understanding of radio receiver operation and dynamic testing by signal tracing is not clear.

-50-

Bench Notes

(Continued from page 19)

"Did you ever stop to realize current flows backwards in a meter? Sure enough! Connect a battery and meter in series. The juice, of course, flows from positive to negative. Starting from the plus side of the battery, it passes through it to the negative side, through the meter from negative to positive, and back to the negative side of the battery. The electron stream—"

"Wait a minute," Pete said, "that's not right! When—"

"Of course, it's right," Kane insisted. "Otherwise, why do meter coils have to be wound from top to bottom? It's as certain as the fact an 80 has two filaments!"

"Or the fact," Pete laughed, "that all radio signals take the shortest path between transmitter and receiver."

That was going too far. After all, we were supposed to be in business.

"Mr. Kane," I announced firmly.

"Yes," he said, as if to a child.

"GET OUT!" I shouted, staring at his chin as if it was tempting me. He went, and I slammed the door instead.

"You, Pete!" I yelled. "Get back to work!"

The things a store owner has to go through! So help me—if that guy ever comes in again, I'll throw him out before he has a chance to open his mouth. After all, a businessman has some rights!

(Do you agree with Pete's handling? The boss' actions? Kane's technical concepts? Let us know why you do—or don't—and we'll have a worth-while discussion in the November issue, when prizes are awarded!)

-50-

Legal Advice

(Continued from page 23)

The courts have held that a check is a "bill of exchange drawn on a bank, payable on demand."⁴ That makes a "head-check" (or one drawn for some future date) a very bad form of promissory note. Do not take this kind of check; they are very difficult to collect. But to continue with checks: as we said, they must be payable on "demand"—that is, dated the day they are drawn, which makes them payable on demand.⁵ In fact, it has been held that a check must be "instantly payable on demand"⁶ in order to comply with the law. This is mere legal verbiage, and usually a check that is dated the day that it is drawn, is payable "instantly" on demand. Well, how about one drawn on a Sunday? Should your customer make the date on Monday? No, certainly not. The law permits you to "present" it on the next non-holiday. So a check drawn on Sunday or a holiday usually is perfectly valid.

How soon after you receive the check must it get to the bank? That again is a matter of being "reasonable." The law says that it must be presented within a reasonable time⁷, or else you must be able to show some good excuse why you did not present it within that time.⁸ Such an excuse would be where your shop is located in Florida and the check is drawn on a Los Angeles Bank. The time for the check to travel by ordinary mail is not counted against you (or your bank) in figuring the time of presentment.

Supposing that your customer has a spat with you and tells you that he has stopped payment on the check. Then you need not present it, you can sue right away.⁹ Some states require that you present the check before you can start your suit, but in those where the N.I.L. is in force, generally will excuse your presenting the check if payment is stopped.

Supposing that the check is improperly made out, can you correct it? No, you cannot. You may not change the date,¹³ nor the sum¹⁴ (you already know all about raising a check), nor the place or bank of payment,¹⁵ nor the number or relations of the parties to the check.¹⁶ Nor can you change the medium through which the payment is to be made, nor add a place or bank of payment when the check has none on its face. Incidentally, a check drawn without mentioning any known state or national bank, is perfectly good—it may be a private bank.

Why can't you change the relationships of the parties? Because one might be a guarantor, or a security holder, and by changing his position, you destroy his guarantee or security.

Next month we will go further into the matter of checks and notes. Best of all, it is to accept only from those persons whom you know well, and take only notes which are payable at banks where the maker has and maintains an account.

-50-

RADIO PHYSICS COURSE

by Alfred A. Ghirardi

(Continued from July, 1940)

FILAMENTS

The mixture is baked on to the filament wire in special ovens. When the filament is assembled with the other elements in the glass bulbs, and the bulb is being exhausted, it is lit up to red heat by a source of current. This high temperature breaks down the carbonate coating and the reaction with the air in the tube forms an oxide coating and carbon dioxide gas, the latter being drawn off by the vacuum pump. The coating left on the filament wire core is a combination of barium and strontium oxides which adhere to the filament wire due to friction at the interface together with a certain rigidity of the mass as a whole that results from the interlocking particles. This coating when heated to a dull red heat of about 750° C. by the heat produced in the filament wire due to the current flowing through it, will emit electrons freely. The same electron emission may be obtained from oxide coated platinum at 950° C. Considerable research work is being carried on to determine the exact nature of the effect of the core metal on the emission and whether the real source of electron emission is a layer of metallic barium on the surface of the core or whether it takes place from a film of barium of atomic thickness on the surface of the coating. It is expected that the results of this work will lead to the development of even more efficient coated filaments that we now have.

Of course, oxide-coated filaments cannot be reactivated as thoriated tungsten filaments can, since all of the active material is on the surface of the filament wire or cathode, and when this is once used up, it cannot be replaced. When the active coating is all used up, the electron emission of the tube drops to a point where it is insufficient to keep the tube operating satisfactorily.

This loss of electron emission may cause impaired set performance in a number of ways. For example, in the case of rectifier tubes the loss of emission means that the rectified voltage supplied by the tube is reduced to a point which reduces the sensitivity of the set, introduces distortion in the output, and limits the volume at which the set can be operated.

In the case of output tubes, the maximum obtainable volume is reduced. If this reduction in volume is carried to an extreme, the set develops an extremely harsh and rasping quality.

In the case of the detector and audio stages, somewhat similar effect in quality is obtained as the tubes wear out.

In the radio frequency stages, a loss of sensitivity and corresponding loss of volume results.

(To be continued)

Learn RADIO

and SERVICE WORK with

Ghirardi's

BIG 3



RADIO PHYSICS COURSE

BASIC FUNDAMENTALS

Here's your start in Radio! If you are a beginner, this one big, all-inclusive, short-cut, self-instruction book of nearly 1,000 pages with over 500 illustrations will give you a thorough training in the important Fundamentals of Radio, including Sound, Television, Cathode-Ray Tubes, etc.—all the essentials, all the background you need for a complete radio knowledge.

No math—no previous training necessary. And you can learn it all easily by yourself at home, checking your progress with the 856 self-examination Review Questions. Ghirardi makes everything crystal-clear and easy to understand. That's why this same Radio Physics Course is used and highly praised by more radio schools and students than any other radio text in the world!



972 PAGES \$4
508 ILLUS.
856 REVIEW QUESTIONS

MODERN Radio SERVICING

LEARN HOW with this!

This famous Ghirardi text gives you a complete 1300-page training course in practical radio service work. It's an illustrated "gold mine" of servicing knowledge, starting with a thorough 420-page treatment of servicing instruments and continuing with nearly 900 more pages of a complete step-by-step procedure course in trouble-shooting, testing, aligning and repairing all makes of sets—all based on practical experience. Here's what you learn:

- Test Equipment—Theory, Descriptions, Diagrams of all Commercial Instruments, How They Work, Construction Data.
- Trouble-Shooting—Newest short-cut methods for all sets.
- Repairing—Advanced "Factory Methods" explained fully.



1300 PAGES \$4
708 ILLUS.

RADIO Trouble-Shooter's HANDBOOK

WORK with this!

Every page of this big Ghirardi Handbook is crammed full of vital factory-checked servicing reference data urgently needed by every service man. Regardless of make and model of set, and what the trouble is, this Handbook will speed up the repair. Used daily by thousands of smart service men. Contains—

- 3,313 Case Histories—Trouble Symptoms and Remedies for 3,313 models of receivers most frequently serviced.
- I-F Peaks—Alignment Data for over 15,000 Superhets.
- Other Data—Auto-Radio, Installation and Servicing Data; Noise Elimination; Servicing Home Recorders and Intercommunications; and 40 more sections of data tables and charts.

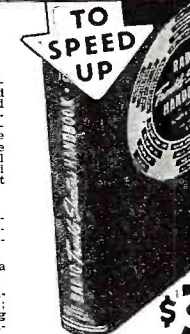

518 PAGES \$3
134 ILLUS.

MAIL COUPON TODAY!

RADIO & TECHNICAL PUBL. CO., Dept. RN-80,
45 Astor Place, New York City.
Send postpaid, with 5-Day Money-Back Guarantee:
 RADIO PHYSICS COURSE \$4. (\$4.50 foreign)
 MODERN RADIO SERVICING \$4. (\$4.50 foreign)
 RADIO TROUBLE-SHOOTER'S HANDBOOK \$3. (\$3.50 foreign)
 BOTH SERVICING BOOKS at Special Combination Price \$6.50 (\$7.00 foreign)

Name

Address

City

State

Please send FREE illustrated descriptive literature.

MONEY BACK IF NOT SATISFIED

As I See It!*(Continued from page 9)*

so! Some expansion is more than ever indicated right now. What with *FM* and *Television* coming along . . . slowly, but nevertheless coming along, there is not any real reason why reasonable expansion is not a wise thing. It will still be true that the early bird will catch the worm! And that the ready serviceman will cash in.

Amateur Competition

A WEEK ago, in a friend's service shop, I watched the proprietor kiss a sweet profit good-bye. . . . He also made an enemy. . . . And one with a "loud-speaker," at that!

**5000
SOLD THE
FIRST MONTH**

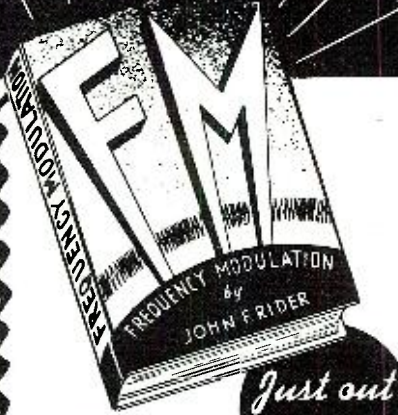

**136 Pages
72 Illustrations**

Now is the time to get into F. M. . . . the greatest development in radio since the beginning! FCC has authorized commercial transmission. This means more and more F. M. stations will be broadcasting . . . more and more receivers will be put into use. Already, thousands of servicemen are preparing themselves to cash-in on the service that will soon be required, by studying this brand new Rider Book, the first authoritative description and analysis of the fundamentals of F. M., and how to service the new F. M. receivers. Don't wait . . . get your copy of this important new book right now to be sure that you are ready to reap the profits of this new opportunity!

YOU NEED EVERY ONE OF THESE FAMOUS RIDER BOOKS
Frequency Modulation; Servicing By Signal Tracing; The Oscillator at Work; The Cathode Ray Tube at Work; Servicing Superheterodynes; Automatic Frequency Control Systems.
"Hour A Day With Rider" Books on: Resonance and Alignment; Automatic Volume Control; D-C Voltage Distribution in Radio Receivers; Alternating Currents in Radio Receivers.

JOHN F. RIDER PUBLISHER, Inc.
404 Fourth Ave., New York City
Export Div.: Rocke-Int. Elec. Corp., 100 Varick St., N.Y.C. Cable: ARLAB

Read RIDER BOOKS

It seems to me, that the radio ham, although he is usually a poor customer, and oftentimes an annoying one, can be of inestimable use to the serviceman. More often than not, he cannot repair a radio set. True, he can install an antenna. But real alignment of IF's, or trouble shooting are foreign territory to him. Make him your friend. . . . And he will send you many customers.

Rather than admit that he cannot repair that obstreperous receiver, he will say, "Why not get Joe Doakes . . . the serviceman . . . I know him well . . . swell guy . . . knows his stuff. . . . He'll do a fine job for you." That kind of advertising cannot be bought. And you can have it for a kind word, and interested nod, or just an attentive ear.

The trouble with the serviceman is not the radio ham . . . it's the serviceman who, in those cases, is his own worst enemy!

I knew a big, and well known physician once who told me that he never worried about the *quacks* in the profession because when they had so badly muddled the case that it seemed hopeless, he was called in and could—when the patient was financially able to pay—charge a whopping big fee for what would have been a cheap and a simple operation without the *quack's* intervention. Take a lesson from that man . . . if an amateur serviceman dabbles with a set, it's ten to one that he will make a better paying job out of that very same set for you. So don't worry about the amateur serviceman . . . just hoe your own row. And make a walking advertisement and friend of the radio amateur. . . .

F.M. and Tone Controls

WILL someone please tell me why—if F.M. is supposed to be the finest reproducer of music via radio—the F.M. sets mostly all have tone controls? I know that to one person's ear what sounds good, sounds very bad to another's. But when we have the classics played for us by such masters as Toscanini, don't you agree that perhaps we might leave the tone values to him, and run the set "wide open" or with "full tone", and not deliberately pick out that "boooooooommmmy" base? Perhaps the manufacturers feel that since they cannot please all the persons at one time, they give each the right to have his music the way he wants it. Perhaps they are right at that. But as I see it, the time will come when F.M. receivers are manufactured without "tone control".

Prophecy

DON'T say that I did not warn you. Home recording combination radio receivers will be the hottest thing this year. With some manufacturers bringing out 10c recording disks, the home recording group will get many new converts, the same as home movies. Don't say I did not let you know in advance; and study up on *constant amplitude vs. constant velocity* recordings, *percentage distortion*, *Christmas Tree Patterns*, and the like. It will be money in your pocket. —50—

For the Record*(Continued from page 3)*

of the long wave bands. If you know any foreign languages, listen there, and if you hear anything suspicious, report it to the *F.B.I.* being sure to give the *hour*, the *station* and the *date* on which you heard the seditious remarks. Also include your own translation of what you heard. While you may think that your letter will not be acted on, we have every assurance that the *F.B.I.* is actually investigating each and every one of these reports.

Those who listen on the short wave bands are able to do the very same thing. The location of the transmitting station is sometimes hard to figure out, but just send along the call letters. As long as we have love of our country and the thousands upon thousands of listeners, we should be able to make short work of any *5th Column* activities throughout our land. Don't be the one to say, "Oh, well, let George do it!" You do it; *every little bit of information counts.*

* * *

WE have been asked many times why the various broadcasters abroad do not jam each other. There are two reasons for this. Firstly, if the Germans jam the Allies, there will be a reciprocation, and the Allies will jam the Germans. This would prevent the latter from reaching out with their propaganda to foreign countries. The opposite will also happen if the Allies jam the Germans in the first place. Then, too, there is always a chance that the announcer of the enemy might slip and some slight piece of information valuable to the cause might get through. That's why each side does listen to the other, and refrains from jamming.

Incidentally, there has been some jamming, but only between the Italians and the British. It is reported that this was wholly accidental and unintentional.

* * *

DUR *F.C.C.* is certainly on the job these days. Not only have they been charged with the policing of the airwaves, but they are investigating all "suspicious" radio phenomena. Aiding them at every turn are a hand-picked bunch of patriotic hams who are freely giving of their time and equipment to help their country. You never see them mentioned, these hams, but they are working just the same. What you do see, is the ever increasing list of convictions against radio racketeers. More power to the *F.C.C.* and their unknown ham-aides!

* * *

HOW about jobs in the professional field? Read what Jerry Coldby says in his column, *QRD?* this month. We know that there are going to be appropriations under the new Defense Act for loads and loads of new radio equipment and men to run it. Why not consider joining the Military Ra-

dio? Swell life, good pay, and a practical profession when you get out. Apply to your nearest recruiting station, or write us, and we'll tell you where to send your application.

For those who cannot, for one reason or another, join the armed forces of our country, there will be many jobs in factories, and as civilian instructors not only at Army Posts, but also with the C.A.A. and at the various colleges and schools featuring aviation instruction. Look around you fellows, there's things a-stirring!

THE other pee-em our phone rang, and a cultured lady's voice asked, "Pardon me, can you tell me where I can receive that *Lord Haw-Haw*? You know, the *English comedian* who is working for the *Germans*?" Well, of all things!

THIS month we add to our already long list of departments. Many of our readers have expressed a desire to know just what is going on in the field of the professional radiops. Not from the personnel side, presently adequately covered by Jerry Coldby's *QRD?* column, but from the standpoint of just what was what in the matter of equipment. We bow to these readers' requests and give them the column, *Utility Radio*. In it you will find the latest advances in the field of Police, Aviation, and Marine radio. Further information about any one particular piece of equipment can be had by writing to the *Utility Radio Editor* care of this magazine. Be sure and mention the manufacturer's name. We hope that you will like the new department. Incidentally, if there's anything else you want in *your* RADIO NEWS, do not hesitate to drop us a line.

AND that about winds up the stint for this month. How's the fishin'? Good? Well, we'll join you during our vacation, just coming up. Save us a piece of bait, will you? . . .

And a radio receiver.—KAK. —30—

Cut Loose from Chaos
(Continued from page 25)

and resistance, such as lamps, shunted across the line.

Next best is a tuned link circuit, used in the higher grade of factory-production receivers. A separate engineering job would be necessary for each installation, to make an antenna tuning system "track" with the gang condensers of the other circuits for single control. A link circuit can be aligned by any service man, being less affected by variations in antenna dimensions. As an add-on unit, it requires an extra control, but results justify this slight complication. Figure 7 shows the hookup as applied to an a.c.-d.c. midget. The same goes for a straight a.c. receiver, omitting the protective condenser, C. A secondary coil shunted by a variable condenser (V.C.) forms a wave trap which absorbs energy of the one frequency for

which it is tuned, while the rest of the r.f. drains off to ground. Heavy current of the desired frequency oscillates in the resonant circuit of the wave trap, sending r.f. shocks to P. There is a circuit through P, C, and the capacity between the wave trap and the ground coil. Selectivity is much improved. Connecting points 1 and 2 were found to spoil tuning; connecting 3 and 4 made no improvement; so it is recommended to leave the wave trap "floating" as indicated.

As a.c.-d.c. sets have no ground post, it will be necessary to make a good electrical connection with the chassis —after pulling out the power plug. Right at the chassis place condenser C, a .01 mfd. (one-hundredth microfarad) paper condenser of at least 400 volts rating; then the ground coil, 10 turns of well insulated wire wound around the wave trap coil. The latter may be of 245 microhenries inductance to tune with a .00035 variable condenser. Suggested, 210 turns of No. 30 Double Cotton Covered wire on a tube of one-inch diameter. The coil itself will be four inches or more in length. If too large, remove one or two turns at a time and try again. It is easier to remove turns than to add them. The completed tuning unit can be set on top of the receiver or close by, keeping connecting wires as short as practicable. If long waves seem weak, try a loading coil.

A midget set of the a.c.-d.c. type, out in the kitchen, using its flexible wire as an antenna, does a fadeout when the *Kennedy 64-B* is tuned to the same frequency. Well, you can't all use the telephone at the same time, either. Anyhow, this phenomenon proves that the midget really receives from the line, and that the wave trap attached to the *Kennedy* actually absorbs r.f. energy from the house wires. It is unlikely we are robbing Next-Door Neighbor, as he has separate feed wires crossing his back yard, longer and higher than the average antenna. Turning up the volume control on the midget brings back locals. Another dodge is for the more sensitive receiver to get the program from some other station on the same chain.

The wave trap is too large to tune short waves, although they can be heard. Waves shorter than 30 meters are erratic, anyhow, rapid fading tending to mask resonance points. Figure 8 shows how the coil can be tapped, mainly for band selection. The first section of five turns should be spaced about the thickness of the wire, all others close-wound. The switch blade has a backward extension that shorts out the fixed condenser (.00025) for 190 to 540 meters. On all short-wave bands this condenser is in series with the V.C., cutting maximum capacity to 150 micro-microfarads, a fair range for 20 to 50 meters. Dead sections of the coil are shorted by the wire W, running from the "long" end of the coil to the pivot of the switch blade. Diagram shows setting for 190 to 540 meters.



UTTERLY NEW!

**STRANGELY AND BEAUTIFULLY
UNLIKE ANY RADIO RECEPTION
YOU HAVE EVER HEARD**

FREQUENCY MODULATION . . . the sensational new and entirely different system of radio broadcasting and reception . . . has been approved and declared "highly perfected" by the Federal Communications Commission. It is generally predicted that some 1000 new F.M. transmitters will be installed at an early date. More than 20 are already in full operation. A completely new type of receiver is required for this amazing new Frequency Modulation reception! Always for ahead, Mr. E. H. Scott has developed a magnificent new SCOTT custom built F.M. Receiver which is causing a sensation. It creates a perfection in radio reception far above any the world has ever known!

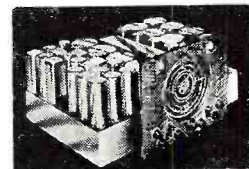

**NO STATIC
NO INTERFERENCE
NO "NOISE"!**

Frequency Modulation reception by the remarkable new custom built SCOTT is incredibly beautiful . . . like a dream come true! NO STATIC, no interference, no "noise" can be heard within the service area of the F.M. Transmitter. In fact, the most favorable conditions for demonstrating are in the midst of a crashing electrical storm, where the ordinary radio is rendered useless! During pauses between programs or stations there is nothing but deep silence . . . only the dial lights tell you the current is on. Tone is so utterly realistic it is practically impossible to tell the difference between the original sound and SCOTT F.M. reproduction!

BE FIRST TO OWN THE F. M. SCOTT!

Don't wait. Be among the first to own this sensational new home entertainment. The custom built SCOTT is now ready to receive the new Frequency Modulation programs on the new F.M. wave band allotted by the government. ONLY the SCOTT gives a 5 year guarantee and custom builds to order, with infinite precision. The newest SCOTT offers local broadcast, short wave, and the new F.M. reception all on one chassis! Send now for amazing facts and moderate prices.

MAIL COUPON FOR MONEY SAVING OFFER!

E. H. SCOTT RADIO LABORATORIES, INC.
4440 RAVENSWOOD AVE.
DEPT. 5N40
CHICAGO, ILLINOIS

Send all the facts, analysis of SCOTT receivers, and orderblank. NO obligation.

Name.....
Address.....
STUDIOS: NEW YORK, CHICAGO, LOS ANGELES, DETROIT, BUFFALO



DESIGNED for APPLICATION

MODERN SOCKETS for MODERN TUBES! Long flashover path to chassis permits use with transmitting tubes, 866 rectifiers, etc. Ideal for mounting on rugged thick cast aluminum chassis now being used on much of the better commercial equipment. Long leakage path between contacts. Contacts are type proven by hundreds of millions already in government, commercial and broadcast service, to be extremely dependable. Sockets may be mounted either with or without metal flange. Mount in standard size chassis hole. All types have barrier between contacts and chassis. All but octal also have barriers between individual contacts in addition.

Catalogue Upon Request

JAMES MILLEN MFG. CO. INC.
150 EXCHANGE ST. MALDEN, MASS.

THE NEW BUD WAVE METER

A Necessity In EVERY Amateur Station

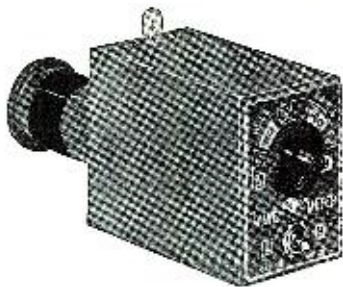

This device is intended primarily to assist in tuning the various stages of an amateur transmitter to the desired wavelength. It consists of a coil and condenser combination accurately calibrated for all amateur bands from 10 to 160 meters, together with a small pilot bulb for indicating resonance. Bandswitching eliminates plug-in coils.

Ask for your copy of the latest BUD Catalog at your jobber's.



BUD RADIO, INC.
CLEVELAND, OHIO

Build This Simple Superhet

(Continued from page 31)

listener is glad to avoid using after the novelty of the first few days has worn off. It may be that a number of people derive casual pleasure from the short-waves; most of these cease to use them after a while, although some graduate to the ham ranks, whereupon they despise this illegitimate use of the broadcast receiver for its shortcomings anyway.

The foregoing is based on habits I have observed among my friends and acquaintances, and may not be general, although it probably is. What about tuning convenience? Since the perfection of single-dial control, there have been no really significant improvements. This resurrection of push-button and telephone dial tuning, inspired no doubt by the periodic dearth of adequately startling advertising copy, represents a convenience gain of nil. A couple of medieval scholastics could have quite a nice discussion on the subject of whether turning a knob a few degrees involves more material and spiritual work than pushing a button, and if so, how many ergs. The main point is, with either system, one must still read a number or a group of letters, and therefore one must still be more or less literate. I will not go so far as to say that the radio manufacturers are seeking to reduce the literacy of our citizens, since this would curtail the effectiveness of their advertising, but I will say that between a system of tuning by turning a single knob, and tuning by a system of thought-waves, mental telepathy, or wish-fulfillment, there is no satisfactory middle way.

At this point the reader no doubt expects a description of the author's ideal in broadcast receivers. He will be partially satisfied. Although I grieve to see this lofty polemic degenerate into a mere construction story, something constructive seems to be in order. Yet I am almost ashamed to present the usual photographs and schematic diagram. This receiver was not so much designed as hacked out from a wilderness of widgets and gadgets which encumber the accepted design of modern receivers. It therefore resembles a public address outfit, which is not surprising, firstly, because p.a. systems do have a tendency towards sanity and economy in design, and secondly, because it was made for a mild sort of p.a. work for a social group. It therefore has separate low- and medium-high-gain channels for crystal phonograph pick-up and microphone respectively.

The first consideration is the r.f. circuit. The only reasonable choice here, since the short-waves were definitely not wanted, was a t.r.f. design with diode detector. Automatic volume control was chucked out the window with a cynical leer. I am given to understand that in certain high-

priced brands of communications receivers the avc system actually does help some on fading signals. On a somewhat cheaper brand I happened to listen in on a short while ago, the manufacturer foolishly provided a

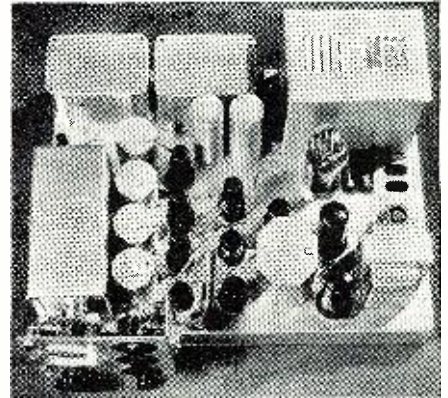

Topside chassis view.

switch on the front panel for cutting the avc in or out. I joined the owner of the set in wondering what change, if any, the position of this switch made. It is not necessary further to press the obvious inutility of avc in a broadcast-band receiver, where one listens to at most a dozen local stations, whose fading is negligible.

The r.f. circuit, then, save for the pentode tubes, dates back to the time when *de Forest* put a grid into *Fleming's* valve, nor is there any reason why it should be different. To one who has spent hours chasing bugs in superheterodynes and lining them up, t.r.f. is like a vacation. Provided the plate and grid leads are short and well shielded, it is almost impossible for it not to work right. The aligning can be done sufficiently well by ear when tuned in on a station. The tubes used in this portion of the set are three 6K7 r.f. amplifiers followed by a 6H6, one diode of which is used for detection. There is only one small out-of-

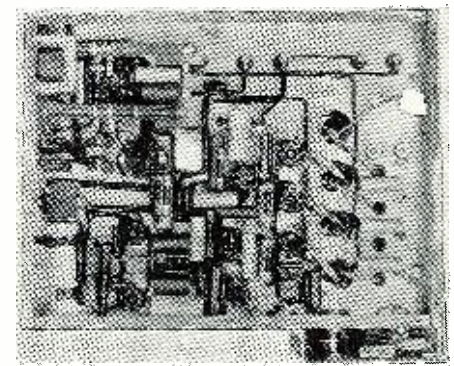

Underside the chassis.

the-way item to be observed here. Since no r.f. gain control is used, it is necessary to prevent overloading of the r.f. system by using a high value of cathode bias resistor, 10,000 ohms, for the first 6K7.

The audio system consists, of a 6C5 driving a pair of 6L6s in Class A with inverse feedback. With these tubes, the increased investment in an input transformer with a split secondary

and several resistors and condensers, is well repaid by the noticeable improvement in audio quality. Additional channels for microphone and phonograph pick-up are provided by a separate pair of 6C5s, one of which is preceded by a 6J7 to give sufficient gain to operate with a crystal mike. Unless the mike has a long cable, additional gain is not necessary. The plates of all three 6C5s are in parallel, thus affording a smooth mixing system. In order that the primary of the input transformer should not carry plate current for all three tubes, only the radio input 6C5 is connected directly to the transformer. The plates of the others are fed through 100,000 ohm resistors, the a.f. output being taken through 0.1 mf. condensers. This system throws the plate and external impedances all in parallel, but a careful listening test did not show any loss in frequency response, although there is a slight loss in all-around volume as compared with operation of any one single tube. No decoupling filters were found to be necessary.

Aside from the extra input channels, one could scarcely design a simpler receiver yielding equivalent performance. Needless to say, on the basis of the schematic diagram alone, this receiver would be expected to give high-fidelity output, depending on the quality of the a.f. transformers and the speaker. This brings up a number of points. It is inadvisable to buy "high-fidelity" transformers. The frequency response afforded by these higher-priced units may be wider and more faithful than that given by the ordinary variety, but the human ear is quite inappreciative of the nuances revealed by a standard frequency record and output meter. A fairly flat response from about 50 to 7500 cycles is ample and easily obtained with the medium-priced units put out by the various reputable transformer manufacturers. It is preferable to invest in husky and well-shielded power supply units, such as are made for low-powered amateur transmitters. These, together with high-voltage and line fuses, will guarantee a long life to the outfit. Similar advice goes for the speaker. To handle the output satisfactorily, a good 12" speaker capable of taking at least 12 watts should be used. Any of the well-known makes may be used and all have a response of the order 50 to 7500 cycles, which is a further argument against using high-fidelity transformers which amplify frequencies that will never be reproduced by the speaker, even if you could hear them with your own ears. Remember also that a speaker of this size should have a baffle area of at least 9 sq. ft., and preferably more.

A ten-cent can of aluminum paint, smoothly applied to all external parts and chassis, will give a clean finish to the job superior to most factory-built sets. This is not so good for heat radiation, but is a worthwhile concession to eye appeal.

Servicemen's Money Page

(Continued from page 39)

ing the primary for impedance coupling and inserting a coupling condenser of 2 mf. or larger as shown in (a). The condenser must have the necessary high voltage rating.

13. **Filter Choke, Open.** In either small or large sets, the filter choke which is open can be replaced by a resistance. The resistor must be capable of handling the current and power involved. A value of 5,000 to 10,000 ohms is suitable for small sets. In (a) the application shows one 5,000 ohm, 5 watt re-

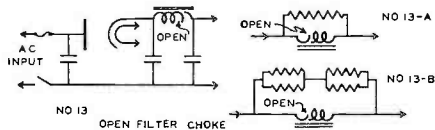

sistor. In (b) the application shows four 5,000 ohm, 5 watt resistors connected in series parallel to give 5,000 ohms with a 20 watt rating. The power that will be dissipated in this resistor is the total current squared multiplied by the resistance value.

14. **Audio Volume Control, Defective.** Knowing the total resistance of the volume control and estimating the position which

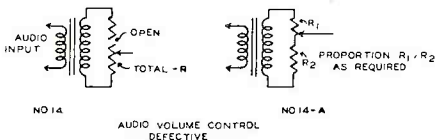

ordinarily will give satisfactory results for most stations, a fixed control can be substituted as shown in (a) consisting of two suitable fixed resistors.

15. **Sensitivity Control, Defective.** The application is similar to (14), a fixed resistor (R-1) being used to replace the adjustable

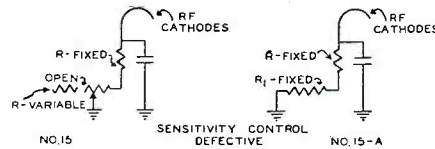

unit. The value should be low as possible, but not so low as to cause the amplifier to oscillate at any position of tuning.

16. **Rectifier Tubes, Interchangeable.** In the recent series there are two basic rectifier socket connections as shown in (a) and (b). By wiring an 8 contact Octal

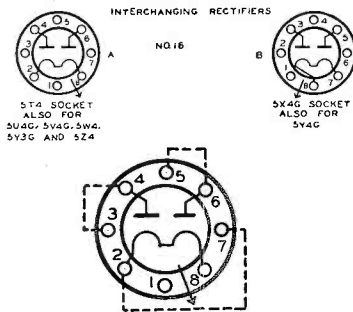

NO.16-C

OCTAL WIRED (ADD DOTTED CONNECTIONS FOR BOTH TYPE BASE CONNECTIONS.)

socket as shown in (c), the same socket will receive either of these two types of rectifier pin connections. The rectifiers are either for small, medium or large current requirements. This arrangement permits using available rectifier tubes temporarily, if required, even if they are a bit above or below the required capacity.



HOT OR COLD, Mallory Condensers stand up—that is the secret of their popularity. There are temperature limits which must be observed for any type of condenser. When the operating temperatures are near these limits it is essential condensers with extra durability be used to insure satisfactory performance and freedom from break-down.

Mallory Condensers have an added factor of safety—special constructional features which provide longer life. You benefit from this extra, deluxe quality—yet thanks to modern production methods, Mallory Condensers cost no more.

There is an economical, long life Mallory Condenser for every filter circuit application — types ranging from transmitting and television capacitors of 6,000 volts to low voltage bypass condensers of 4,000 mfd. capacity. There are ultra compact FP (Fabricated Plate) and etched plate filter condensers for radio receiver service. All are built for easy installation. Complete information is in Catalog Form M-770, available without charge from your distributor, or from the factory.

Amateurs, servicemen, and experimenters are urged to discuss their condenser problems, whether for original application or for replacement service. The advice of Mallory Condenser experts is yours for asking. Address, Application Engineering Section, Wholesale Division.

P. R. MALLORY & CO., Inc.
INDIANAPOLIS INDIANA
Cable Address—Pelmalto



Bliley Vari-X



**VARIABLE
CRYSTAL
OSCILLATOR**



Provides e. c. o. frequency flexibility with quartz crystal stability

The Vari-X with VF 2 Crystal Unit is a full crystal controlled variable frequency exciter for 40 and 80 meters. See your Bliley Distributor at once for complete details.

ASK FOR CIRCULAR D-2

BLILEY ELECTRIC CO., ERIE, PA.



Now Tinydync Radio
BROADCASTS YOUR VOICE LIKE A RADIO STATION — to any ordinary radio within 100-150 ft. away! Between rooms, apts., houses, offices — almost anywhere. No electric plug in — flashlight batteries. "MikePhone" tubes & attachable "Magicenna" (eliminates outside aerial). Size only 3x4 1/2 x 1 1/2". Wt. 22 ozs. Simply connect & "Tune in" on nearby radios or other "TINYDYNES" (Makes complete "Wireless Phone"). Also receives many radio stations clearly — With No Changes or Extra Wires! New Model broadcast & receives on Short Wave, Standard, and Long Wave! Anyone can operate it with our simple directions. A barrel of fun and amusement for everyone. Many practical uses! Finished in beautiful crackle steel case! Send Only \$1.00 (Check, M.O. Cash) and pay \$4.99 plus postage on arrival. Absolutely Complete! One Year Service Guarantee! Order Now!
MIDGET RADIO CO. Dept. THG-3 Kearney, Nebr.

Not an Attachment or Toy! Ready to Operate with self contained flashlight batteries. "MikePhone" tubes & attachable "Magicenna" (eliminates outside aerial). Size only 3x4 1/2 x 1 1/2". Wt. 22 ozs. Simply connect & "Tune in" on nearby radios or other "TINYDYNES" (Makes complete "Wireless Phone"). Also receives many radio stations clearly — With No Changes or Extra Wires! New Model broadcast & receives on Short Wave, Standard, and Long Wave! Anyone can operate it with our simple directions. A barrel of fun and amusement for everyone. Many practical uses! Finished in beautiful crackle steel case! Send Only \$1.00 (Check, M.O. Cash) and pay \$4.99 plus postage on arrival. Absolutely Complete! One Year Service Guarantee! Order Now!
MIDGET RADIO CO. Dept. THG-3 Kearney, Nebr.



HQ-120-X

Dual Stabilized

"HQ-120-X" stability is doubly insured by drift compensation in the high frequency oscillator circuit and automatic voltage regulation to compensate for line voltage changes. These two very important features, together with many others, have made the "HQ-120-X" the outstanding medium-priced receiver. Thousands of Amateurs, and Short Wave Listeners have been obtaining truly remarkable results. Whether it is for operation in crowded amateur bands or for bringing in foreign news broadcasts, you will find the "HQ" tops them all.

WRITE FOR "HQ" BOOKLET!

HAMMARLUND MFG. CO., Inc. RT-8
424 W. 33 St., N. Y. City
Please send 16-page "HQ" booklet

Name
Address
City State



Canadian Office: 41 West Ave. No., Hamilton, Ont.
Export Dept.: 100 Varick St., N. Y. City

A Simple Receiver

(Continued from page 15)

and the selectivity with such a short antenna is remarkably good. The short length of No. 12 is entirely self-supporting, and is connected to a small feed-through insulator on the front panel. The antenna can be left in this position when the set is carried about, unless it is desired to pack the set in a restricted space, in which case the antenna should be removed. (Amazing deduction!) The tip of the antenna is bent over to form a small loop. This precaution makes the tip more obvious and less dangerous as an eye putter-outer. It's really hard to believe, but this antenna is far easier to erect than some of the rotary arrays that are so popular.

Battery Requirements

The battery compliment, which is entirely contained in the cabinet, consists of a 1 1/2 volt "A" battery (Burgess "Little-Six"), two 45 volt portable size "B" batteries (Eveready No. 762), and a standard 4 1/2 volt "C" battery (Eveready No. 771). The drain on the batteries is quite conservative, the total "A" drain being 100 ma., and the total "B" in the neighborhood of 8 ma. The set has been used for about an hour per day over a period of three months without noticeable change in the tube characteristics or battery voltage under load.

A DPST switch mounted on the regeneration control cuts both "A" and "B" batteries simultaneously, and in addition, a single-pole toggle switch is inserted in the positive "B" lead for "stand-by."

Construction

A black crackle-finished metal cabinet with hinged lid and removable front panel is used to house the receiver and batteries. Its dimensions are 10" long by 7" high by 6" deep (Bud No. 993). The chassis itself is 5 x 5 1/2 x 1 1/2", and can be made easily by the constructor or cut down from a standard 5 x 9 1/2 x 1 1/2" chassis such as Bud No. 776. Needless to say, the placement of parts is not at all critical as long as the r.f. leads are kept reasonably short. However, the parts layout shown in the photographs was decided upon after considerable juggling of the various components, and is well justified by the results. The small trimmer condenser in series with the antenna is mounted just to the left of the feed-through insulator on the front panel, and it can be adjusted from the front by means of a small screwdriver. For the short antenna described above, the maximum capacity setting of 70 mmfd. is satisfactory for all bands. With a longer antenna, of course, the capacity should be proportionately reduced in order to maintain good selectivity.

Just a reminder: Be sure to in-

sulate the phone jack from the panel. If this is not done, the performance of the set won't be quite what it should be.

Performance

The sensitivity and selectivity are surprisingly good for a set that boasts only two tubes and one tuned circuit. The very short antenna is no doubt responsible for the selectivity. A good ground was found to be of advantage on weak signals, but not absolutely necessary. Incidentally, that bugaboo of a.c. operated regenerative receivers, tunable hum, is of course entirely missing, and this point alone justifies the use of batteries even if no portable operation is contemplated.

As is usual in receivers of this type, the performance is better on c.w. than on phone, although several South Americans have been heard on 20 meter phone, including a Chilean who was a good R8. The receiver has been used on 40 meters most frequently, where its performance compares favorably with a multi-tubed super. Of course it lacks the refinements of the more complex receivers, but it does pull in the signals, "but definitely."

-30-

Remote Battery Amplifier

(Continued from page 14)

"Line Break" jack. Bottom row: "1st 250 Ohm Input" fader, "2nd 250 Ohm Input," fader, "3rd 250 Ohm Input" fader, "High Impedance Input" fader, and the "Master Gain" control. The pilot light serves a two fold purpose; it provides a visual indication that the power is on, and illuminates the face of the meter. The removable hood allows the bulb to be changed whenever necessary without removal of the chassis from the cabinet.

The brackets, in the foreground, are for the purpose of holding a spare set of batteries. The batteries in use are mounted in the brackets directly beneath. The tube sockets, between the brackets for the spare batteries and the panel, are for carrying spare tubes. The tubes in use are shown without their shields on. They are shielded electrically and acoustically with the usual, thin, close fitting metal shields that have been covered on the outside with a quarter inch layer of sponge rubber. Also all of the tube sockets are equipped with rubber mountings to help minimize microphonics.

The faders, spare tube sockets, resistor board, and the terminal board in the rear, all are clearly shown. The plug-in connectors are for the purpose of making connection to the batteries. The batteries and their brackets were removed while the picture was being taken so as not to hide the resistor board.

To get down to cases (no pun intended) one of the next big construction problems was the cabinet. There were several alternatives to choose

from. However, it was decided to turn the matter over to a local luggage shop who custom-built the case from the author's sketches. The case turned out very well and the work was done at a very reasonable figure. Several materials were available for case construction. The fiber body with the metal corners and edges (army locker type of construction) would have been a bit more durable, but not as pleasing to the eye as the black leatherette covered case decided upon. The case was fitted with oversized handle, catches and fittings; to provide additional strength.

The case came lined with green felt and as a result a green color scheme was used in the interior. Green sponge rubber, for the tube-shields, was available and green push-back was used for the wiring. The proper shade of green enamel was mixed with powdered pumice, in order to produce a non-glossy finish that would be durable and that would hide the nicks and scratches in the chassis.

The next consideration was that of the chassis, brackets and panel. The chassis itself was bent up from 20 gauge template. This material was decided upon because of its strength, low cost and because of the ease with which solder adhered to it. The outside of the chassis was painted with the dull green mentioned above, and the inside was polished down with steel wool and left otherwise unfinished. The battery brackets were made from 16 gauge sheet aluminum. The panel was made of one-eighth inch aluminum plate and painted with black wrinkle after all the holes were cut, the back left unpainted.

Nameplates for the controls are desirable in this type of equipment. They add to the appearance and at the same time facilitate operation. Those used on the front panel were made from a photo-etching of an original drawing. The face of the zinc plate was painted with black wrinkle and the raised surface polished off. The individual name plates were cut apart with a hack saw and the edges smoothed down. The plates were fastened onto the front panel by means of rivets made from number twelve copper wire. The heads were touched up with black wrinkle after the plates were mounted.

The purchased, cast aluminum, call letter plates are mounted on the cover and on the rear of the case. They identify the station and add a decorative touch.

General Information

Before closing, a few general notes on operation might be in order. To change the batteries, it is first necessary to remove the amplifier chassis from the case. This is done by removing the four filister head screws that are on the front panel, one in each corner. The amplifier is then free to slide out of the case. The plug-in connectors from the batteries and the four screws holding the brackets to the chassis, should be removed. The old batteries are then lifted out and the

new ones substituted. The mounting screws are replaced, the plugs re-connected, and the unit is ready to slide back into the case.

It might be mentioned that the detent action is removed from the low impedance faders, so that they are smooth in operation. The master gain control is equipped with the detent action. This insures positive resetting of this control. In general use, it will be desirable to run the fader, on the microphone being used, to full open position and then to adjust the master gain control to give a degree of amplification somewhat greater than is required. The microphone fader is run back and any further adjustments of the volume level are made with this control.

In closing it should be stressed that this article is not of the "run of the mill" construction articles that suggest duplication of the circuit and layout without change. Far from it! This merely shows what can be done with the parts available today, a bit of ingenuity, and a small amount of shop equipment. After all, each station has its own remote problems. Some use one type of microphone, some another. An ultra-compact unit is needed at some stations and others need a more elaborate unit. Some use the jack, some the twist-lock, some the tube socket type of microphone connector. One station will want an extra fast action meter and the next one will be satisfied without the use of any meter under certain operating conditions. And so it goes, down the long list of individual details encountered; no two stations having identical problems.

It is hoped that the reader will see from this account, a few of the many possible combinations that can be worked out, and by modification of the ideas presented herein, fill his needs for the "portable broadcast remote amplifier."

Ed. Note: This unit makes an excellent pre-amplifier for the Sound Man.

Mfg's. Data

250 attenuators: International Resistance Company, 401 N. Broad Street, Philadelphia, Penna. Type: B-31-T-250. Circuit: Bridged "T". Imp.: 250 ohms. Attenuation: 1 1/2 db per step to 36 db, tapering to inf.

Master gain: IRC. Type: A-21-250M. Circuit: Pot. Imp.: 250,000 ohms. Attenuation: 2 1/2 db per step to 45 db, tapering to inf.

Jacks, switches and pilot light: P. R. Mallory & Co., Indianapolis, Indiana.

Crystal mike to line transformer: Thordarson Electric Mfg. Co., 500 W. Huron Street, Chicago, Ill. High Fidelity—Ouncer. Type Number: T6A2, 50,000 ohms to 200 ohms. Case style: R1.

Input and output transformers: American Transformer Co., 178 Emmet St., Newark, N. J. Input: Type: OP382, 200 ohms to 100,000. Spec.: 19509. Output: Type: OP364, 20,000 ohms to 500 ohms. Spec.: 19610.

Meter: Weston Electrical Instrument Corp., Newark, N. J. Model: 301. Type: 60. Case Style: Rectangular flush type. Case finish: Black Bakelite. Scale —10 to 6 db. Zero reference power level: 6mw. Line Imp.: 500 ohms. Internal Res.: 5000 ohms. Level at zero: 0.

Case: Custom made by Wehrmann's, 508 State St., Madison.

Sockets and mountings: American Pehnolic Corp., 1250 Van Buren St., Chicago, Ill. Sockets are retainer ring type, cat. no. 59. Antimicrophonic socket cushions are cat. no. 11-3K.

"WIBU" plates: Glenn H. Walker Mfg. Co., Norwood, Ohio.

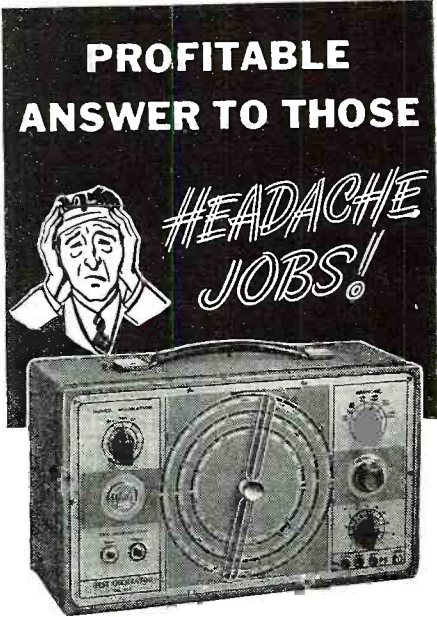

New RCA Test Oscillator #167

\$34⁵⁰

ACCURATE, EASY-READING DIAL

FULL 1.0 VOLT R.F. MAXIMUM OUTPUT

100-30,000 KC FUNDAMENTALS

If you're the kind of serviceman who wants to make money on modern, complex receivers—the tough jobs—this new RCA #167 Test Oscillator was made for you! It has the range you want for today's receivers... high output for single-stage alignment, or for sets misaligned completely. Its big new dial scale makes readings certain and precise. Trim, attractive, business-like appearance wins customer-confidence. Study its features... see it at your RCA Distributor's. \$34.50 is all it costs! Don't buy any test oscillator until you've seen how much RCA can give you for so little!

Check These RCA Value Features!

- 6 Ranges: 100 to 30,000 K.C.
- 400-cycle 8-volt Audio
- Harmonics of 6th Band for U.H.F.
- Complete Shielding
- Precision, New-type Dial
- Metal Tubes—Compact, Stable
- 2% Accuracy

Over 335 million RCA radio tubes have been purchased by radio users.

RCA Test Equipment

RCA Manufacturing Co., Inc., Camden, N. J.
A Service of the Radio Corporation of America

Remotes

(Continued from page 37)

realize and appreciate the advantages of Signal Tracing, he is either kidding himself or us.

The success of Signal Tracing varies directly with the operator's knowledge of radio, and the more a man knows, the more valuable Signal Tracing becomes.

On the other hand, the system (and we flatter it to call it a system), used by Mr. Bradley may be all right for him, but let us see him teach it to anyone else. By that we mean that Mr. Bradley's lone asset is his experience and you cannot teach experience. One must acquire it.

We think Mr. Rider will agree, and we know that Sam Milbourne, who writes for this magazine agrees, when we say that with the proper system, young radiomen with only a minimum of experience and a fair knowledge of radio theory can be made to repair radios more efficiently than a lot of the Bradley type. This is especially true when Signal Tracing is employed.

Taking up the time element, we find that Mr. Bradley admits that he uses a

tube checker. Without a Signal Tracer the only way to check a tube is with a tube checker. Now Mr. Bradley complains about the time he saves that would otherwise be lost in Signal Tracing. If anyone familiar with Signal Tracing cannot go through a radio in less than half the time it will take Mr. Bradley to check a set of tubes, we will make him a present of all mis-matched ties we got for Christmas. And when he gets through with the Signal Tracing process he will know:

1. Condition of tubes.
2. Condition of alignment.
4. Sensitivity of set.
5. Quality of Signal at various stages.
6. And what circuit the trouble is in.

We don't mean to give the impression that a man using a Signal Tracer doesn't need a tube checker. Operating a radio shop without a tube checker is just like operating a filling station without free air and water.

Right here we must break down and hand Mr. Bradley a point on his suggestion of talking the "white elephant" jobs to a distributor or someone who can fix them. This is a smart move whether you are Signal Tracing or Hunting and Poking. We know several good radio men who make money by doing this. The only drawback is that about four-fifths of the nation's servicemen are located in towns far removed from anyone who can repair the job, and most of them have a reputation to uphold. If their customers learn that their sets were taken to someone else for repair, the customer will often say, "Well, why shouldn't I take it to this man myself in the first place." A customer usually brings a radio to a particular radioman because he thinks that this man is the best there is. He hates to be disillusioned.

Along this same line comes the argument of whether it is better to fix only what is keeping the radio from playing with a minimum of time, or to check and find all the weak parts in the set so as to bar as much future trouble as possible.

A man operating in a big city where he gets most of his work from advertising, might afford the first system. But, the man in the small town knows that his reputation is his fortune, and that even if he replaces only a quarter-watt resistor for which he charges \$1.50, he has married that set and if anything happens to it within the next year it is his fault.

The man in the small town is more closely associated with his customers. If he buys a new piece of equipment his customers soon know it and it is good advertising for him. If new equipment doesn't make customer impression, there are a lot of filling stations, garages, doctors, and beauty shops badly fooled.

But Signal Tracing is not a cure-all for the radio service business. To the man who doesn't know the fundamental principles of a superhet, and our experience has taught us that at least two-thirds of the nation's radio fixers do not, we say, "If you buy a Signal Tracer, you are going to be disillusioned." The job of the Signal Tracer is to prove that a certain circuit is either doing or not doing what it is supposed to do. If the operator doesn't know what the circuit is supposed to do, he had better learn before he buys a Signal Tracer, or continue on his Hunt and Poke method.

In the meantime, to those who might be inspired by the words of wisdom of the "Tester," who admits that after 15

years he is still at the same old test-bench, we would like to say that radio servicing is where a man starts in this business and not where he ends up. . . .

(Sgd.) Harold Davis,
Radio Parts & Service,
Jackson, Miss.

-30-

Video Reporter

(Continued from page 25)

by balloting all of the television audience.

FCC Gloom

THERE was a gloomy atmosphere at Radio City the day the FCC announced that commercial operation of television must await the establishment of more definite standards than engineers for competing firms can agree on at this time. One particularly somber note pointed out by an NBC press representative was that one New York newspaper published the story of the FCC's decision on the obituary page!

At the time these lines are being written, NBC declares that there is no intention "as yet" of shortening its already limited television schedule because of the disappointing FCC decision. However, programs are announced only a week ahead and it is likely that schedule alterations can be made on short notice. NBC and RCA have too much at stake in listener good will to withdraw the W2XBS schedule entirely.

In view of the adverse FCC action, continuance of the New York telecasting schedule is a distinct public service. To an extent, RCA is protecting pioneer set buyers by operation of the station on an experimental basis. But program costs are very high even for the skeleton service and how long it will be continued on its present basis is a bit speculative.

Press Agenting Telly

RCA is still clinging to stunting ideas to help win attention to the video art. Some of the stunts are highly involved and it is true that they win television some newspaper space that wouldn't be accorded the industry otherwise. But it's very doubtful that many sets are sold as a result of the trick programs—regardless of how spectacular they are. We still hold to the opinion that it would be more constructive for RCA's New York telecasting station to concentrate on better studio programs on its regular schedule rather than go in for stunts which the public promptly forgets about.

The reception of television programs on shipboard over a 230-mile distance was the most recent stunt.

But it is no longer news to record that television images are received beyond the horizon over much greater distances than once anticipated. Furthermore, we recall that, even as a stunt, shipboard reception is old stuff, one of the early Baird experiments having achieved this long, long ago.

Getting down to earth on constructive program ideas that can be regularly scheduled will go much further towards creating a demand for home receivers and, in turn, promote an earlier launching of commercial television.

W. W. No. 2 & Telly

THERE'S no longer any question about it. Video events of recent months in the U.S.A. have proved that a spirit of international competition is essential to make a new industry thrive.

The start of the European War put television at a standstill in virtually all nations except the U.S.A. Leadership in a new and thriving industry is a flattering thing. But one nation can't boast of being first in a new art when it is the only one active.

Chances are that there would be more accord on standards and other television problems in this country if such unified trade action meant American leadership in a competitive field shared by other nations. And it's quite likely that the FCC would have per-

Simplest WAY TO REPLACE BALLASTS

4 STANDARD TYPES of Amperite Regulators replace over 200 types of AC-DC Ballast Tubes now in use. . . . Has patented automatic starting resistor. List \$1.00.

WRITE FOR REPLACEMENT CHART "S" Amperite Co. 561 Broadway, N. Y. C.

AMPERITE

FREE CATALOG

ALL RADIO NEEDS

Here in this one big book you will find everything you need in radio . . . sets, parts and supplies . . . public address systems . . . amateur equipment . . . testers and kits . . . your nationally known favorites at lowest possible prices. Write today for this big valuable catalog and save money.

PROMPT SERVICE

BURSTEIN-APPLEBEE COMPANY

1012-14 McGEE STREET, KANSAS CITY, MISSOURI

RADIO plus TELEVISION mastered by pre-tested Training

No matter where you are or what you do, National has a complete training plan for you—to fit your circumstances. National's plan is for those seeking immediate shop-training as well as for those who cannot give up present employment and income. Mail coupon below. Find out how you can get the finest in radio and television training.

NATIONAL SCHOOLS

NATIONAL SCHOOLS, Dept. RN-8
4000 So. Figueroa St., Los Angeles, Calif.

Please send free Literature and full details.

NAME _____ AGE _____

ADDRESS _____

CITY _____ STATE _____

mitted commercial telecasts if peace reigned over Europe.

Theatre-Stockholders' Telly
SHOWMANSHIP is a thing radio folk know lots about and RCA applied it in a liberal dose at the recent annual stockholders' meeting in New York. The occasion marked the first public showing of the firm's long-anticipated large-screen television system.

The type was described by RCA as "designed for use in theatres." However, the images, projected on an ordinary beaded screen, measured only 4½ by 6 feet—a size considerably smaller than large-screen demonstrations by other firms in the past. Even RCA realizes that its so-called "large" screen is not large enough when the implication is made that it is suitable for theatres.

However, this claim is rationalized a bit with the explanation that the unit is but an intermediate step in the development of apparatus for projecting much larger images. And RCA also adds that the 4½ by 6-foot size has "interesting possibilities" for use in clubs and schools and other places where the viewing group is under 150 persons.

The "letdown" portion of the announcement, though, was the statement that there are no immediate plans for marketing this apparatus and that twelve to eighteen months will be required for commercial development. This took the merchandising edge off the demonstration. Industry observers can't help reflecting that still larger images were achieved before, but that a market for them just didn't exist. The programming problem will have to be solved before the small home sets are sold in quantity; just when theatres will be ready to invest in television is even a greater enigma.

Large Screen Video

THERE are three basic parts to the RCA large-screen system. The first contains a kinescope projection tube and optical system, the second has the high-voltage power supply and the third houses the circuits, amplifiers and controls. The three units—somewhat bulky—are mounted on a single mobile platform located twenty feet from the screen.

A simple explanation of the system is one applied to old-time vaudeville magicians: "It's all done with mirrors!"

The kinescope image is first thrown in an opposite direction to the viewing screen; it falls on a concave mirror of 16-inch diameter and, magnified 22½ times, it is projected back through a lens surrounding the neck of the picture tube and thrown on the final viewing screen.

A5 vs. FM.

MANY television men share the opinion that frequency-modulation broadcasting got a much better break than it was entitled to by the FCC's action in sanctioning commercialization of FM. The video lads feel that, not only is FM making inroads into frequencies they believe should be assigned to television, but that sight transmission is getting a sort of "stepchild" treatment while FM gets the main breaks.

However, FM and television may not be as far apart as many persons believe. There have been many suggestions of future use of FM for video transmissions and they continue to gain weight.

WCAU, Philadelphia, among other leading broadcasters interested in both FM and television, is planning experiments with FM to determine its suitability for sight-and-sound transmissions.

Book Review

(Continued from page 30)

able sources exist. The receivers being new and the transmissions being rather limited, much data that might be of value are not yet available. However, the receivers are out in the field; a certain amount of practical servicing experience has been had; an appreciable amount of experimental work has been carried on, so that a

fairly comprehensive picture of servicing problems is possible. Contents include chapters on—Frequency modulation, What happens at the transmitter, What happens in the receiver, The transmission of FM signals, FM Receiving antennas, Servicing FM Receivers, and, Bibliography.

Cuttings

(Continued from page 14)

not the case when cutting on acetate type discs. Most manufacturers of recorders, particularly those making portables, seem to undertake the design of the amplifier along general lines. It is only fair to mention that in the Model 1-52-A we find an excellent amplifier that is fully capable of delivering clean speech to the cutting head. There are many considerations in designing an amplifier for recording that do not necessarily apply to those used for PA applications and the manufacturer has carefully considered these in the equipment. The play-back facilities are carefully worked out for maximum results and the quality is excellent. In spite of the fact that a heavy table is used the total weight has been kept to a comfortable figure and the recorder may be carried about with not too much discomfort. Both aluminum and acetate records were cut on both music and voice. The results were most pleasing. The surface noise was particularly low on this machine. The audio response was well balanced for both "highs" and "lows" and distortion was at a minimum for a compact unit of this type. The Model 1-52-A design indicated that all details were carefully considered before manufacture and should stand up in service for many years to come with proper lubricating once a month.

Discussion

Why don't the manufacturer's of portable recorders do something, about storage space for a few discs, needles etc.? Most of them do not have any provision for these and it is necessary to carry a bundle of blanks around in one arm and the recorder in the other. The needles get mixed up or lost when placed loosely within the case, and the poor layman must remember to carry along a few in his pocket. Furthermore, nearly all portable recorders are accompanied with a microphone and floor stand. Ever try to get in a modern apartment building with both a heavy case and stand? Well, if you have, you know exactly what we mean. How about furnishing a stand especially made for the purpose such as a collapsible music type that folds into a small package and can be moved about with ease. I know of several portable recorders that have plenty of room for improvement along these lines. Space is available for a nice large bin that would house a microphone, stand, and discs and still leave plenty of air-space for proper ventilation. Not so long ago I set out one fine morning to make an assortment of sound-effects records. The so-called portable equipment turned out to be an assortment that would make a top-notch window display in a large store. Hint to manufacturers—cut down on the weight of the case, leave the conventional mike stand in the studio where it belongs, add an inch for a record storage bin, and give us a small cup with cover for needles.

The Reader Asks

Is it good economy to purchase a dual-speed recorder?

ANSWER: Yes—by all means do. In the first place, far more playing time is available when recording at 33½ RPM. In further explanation I might state that although it is not good practice to record at diameters less than 6" at this slow speed, there are many times when we can make use of the extra surface on the disc for speeches, war reports etc. It is then possible to record about 14 minutes on an inexpensive 12" disc by extending the cutting all the way in to the normal position. This time is almost equal to regular 16" transcription records but the quality of reproduction will not be as good as those cut at proper diameters and with professional equipment.

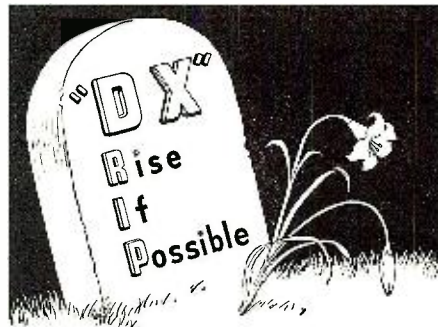

Dstands for dead — and **X**means out of the picture!

Anyway, "D-X" is gone and the F.C.C. says no more talking even to Mexico, which makes the chances for working all zones less than if you used a defunct "201-A" of revered memory!

Now, let's get down to improving the quality of your transmission.

For a quick change from Send to Receive—for a quick return to the air after a power surge—for faster, snappier keying—for that remote control job you've been intending to build for some time—for all those dozens of ways you can improve your rig—let Guardian give you a hand.

Circuit diagrams—specifications—all the dope enclosed with every Guardian Relay. See Your Jobber Today!

... and about these Low-Priced

ANTENNA RELAYS

By GUARDIAN...

Famous for Ease and Flexibility of Mounting—Compact—Famous for Sturdy Dependable Operation.

Tested under actual operating conditions. Relays by Guardian have proved capable of handling any power up to a K.W. on any frequency up to and including 28 M.C. on A.F. or R.F. circuits.

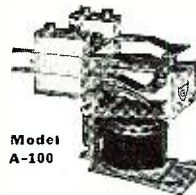

Model A-100

Standard A-100 and A-100-C Antenna Relays Al-Simag insulated operate on 110 V. 60 cycle A.C.

LIST PRICES:

- A-100 Double Pole Double Throw Relay... **\$6.55**
- A-100-C Single Pole Double Throw Relay... **\$3.65**
- R-100-G Triple X insulated..... **\$5.50**

Write for New Bulletin "N" and Free Circuit Diagrams. Order Today!



GUARDIAN ELECTRIC

1630 W. WALNUT ST. CHICAGO, ILL.

Reversible V. T. V. M.

(Continued from page 38)

ion. This is very convenient when measuring voltage directly at the control grid of r.f. or i.f. tubes.

The meter is enclosed in a box 9" x 5" x 6". Because two of the tubes must be readily accessible and in addition the 6E5 must be placed so that its dome faces the operator, all the tubes are mounted with their domes facing the front panel. The 80 and 6E5 are mounted on the subpanel and the 6J7 is mounted on the front panel. The subpanel, a chassis 8" x 5½" x 1½" is mounted against the front panel with four eye bolts. The 6J7 socket, the two potentiometers, Sw1, Sw2, Sw3, and the 2 inch 0-1 milliammeter are all mounted on the front panel, the balance of the parts except C3, C4, C5, R1, R2, which are mounted between the front panel and subpanel, are mounted on the subpanel. The parts are mounted and wired on the panel and subpanel before the two panels are fastened together. The wiring be-

tween these panels is made extra long and cabled so that the two panels can be pulled apart far enough to work on them.

The transformer T1 had to be mounted at an angle in order to fit. A smaller transformer can be obtained that will fit with less crowding. An extra switch will be observed on the front panel which is connected to a condenser mentioned in a later paragraph.

The four foot extension uses a five-wire shielded rubber-covered cable. An octal plug is mounted on one end. On the other end an *Amphenol* Cable Connector Cover is used to mount an octal socket and the two condensers C1 and C2. By enlarging the hole in one end of the cover one of the octal sockets held in place by a steel locking spring will fit nicely. The rubber cable is brought in through the other end of the cable cover through a rubber grommet. A grounded lead with a test clip on the end is brought out from the socket end of the cable so it can be clipped on the grid of the 6J7 while the eye is being adjusted.

To put this vacuum tube voltmeter in use the 6J7 is placed in its regular socket on the panel, and Sw3 is rotated to the voltage range to be covered. R6 is adjusted so that zero voltage is indicated on the milliammeter, then R5 is adjusted so that the shadow on the 6E5 is just collapsed or so that a thin slit shows when the test leads are shorted. For d.c. Sw1 is closed and for a.c. it is opened. Then the test leads are connected to the source of voltage to be measured. The "eye" will either open or close more according to whether a negative or positive voltage is being measured. R6 is adjusted until the eye regains its previous position. The voltage measured is then indicated upon the milliammeter.

To measure low frequencies such as 60 cycles, a 4 mfd. paper condenser must be connected in parallel with C5. This slows up the opening and closing of the eye and is advisable to put in a switch so that the extra condenser can be cut in or left out of the circuit as circumstances permit.

To use the goose neck the "eye" is adjusted with the grid cap grounded. Then the grounded clip and the grid cap are used as test prods and connected directly to the voltage to be measured. A one megohm resistor connected between the grid cap and the voltage source will further isolate the 6J7 and help prevent any reaction upon the circuit measured.

With the constants given the voltages will be about 0-10-70 negative and 0-10-80 positive. As the 0-1 milliammeter is calibrated from 0 to 1 it will read the voltages directly without any further marking on the dial. The 0-1 scale will read 0 to 10 by multiplying each one of the figures on the scale by 10 and the meter scale will read 0 to 100 by multiplying each of the numbers from 0 to 1 by 100. By using a higher voltage transformer T1 the meter will read higher voltages and

by changing the ratio of R8 to R9 the positive voltage range will be greater and the negative voltage range less or visa versa. The voltages written on the panel above the knob on Sw3 are -70 -10 -70 -10.

Manufacturers' Literature

(Continued from page 42)

stant Dynamic checking of condensers makes this an essential radio service help. Two types are available, the model BQC and the QC. The former is designed for capacitor measurements plus qualitative checking, while the latter is designed for qualitative checking of all types of condensers. The capacity ranges are from .00001 to .002 mfd., from 1001 to .2 mfd., and from .10 to 70.0 mfd. Bulletin RC-10 gives a complete listing of the famous *Red-Gap* condensers. Free. (RADIO NEWS, No. 8-109.)

RME-99 BULLETIN 102. Published by the *Radio Mfg. Engineers, Inc.*, 111 Harrison St., Peoria, Illinois, is now available. This describes the new RME 99 receiver, the latest contribution to the radio operator. They have retained such basic and fundamental requirements as the decibel-R carrier level meter, the six-position band-switching selector, the velvety smooth dial mechanism, the automatic noise suppressor, the stand-by relay control switch, the built-in power supply, the crystal filter and the solid one-piece cast aluminum chassis frame, in building this new receiver. Free. (RADIO NEWS, No. 8-110.)

CONTINUING the usual service to RADIO NEWS readers. Each month we have printed short reviews of the leading manufacturers' literature. Under each review will appear a reference number (for instance, the RME Catalog number this month is, RADIO NEWS No. 8-110). All you have to do is to fill out the coupon at the end of the page indicating by number the catalogs you wish to receive, and we will do the rest. There is no charge, unless the review says that there is, and then that is charged by the manufacturer, not us. Each coupon is good for the time limit stated thereon, and no guarantee is made by us that the manufacturer will send out catalogs.

RADIO NEWS, Catalog Dept.
608 S. Dearborn Street, Chicago, Ill.

Please send me the literature I have checked below. If there is any charge I have enclosed the money.

- ... 8-100 ... 8-102 ... 8-104 ... 8-106
- ... 8-101 ... 8-103 ... 8-105 ... 8-107
- ... 8-108 ... 8-109 ... 8-110

Name

P. O. Address

City State.....

I am a Svcemmn ... Ham ... Experiment'r ...
This offer expires Sept. 1, 1940

RADIO ENGINEERING
DEGREE IN 2 YEARS

● Complete Radio Engineering course in 96 weeks. Bachelor of Science Degree. Radio (television, talking pictures and the vast electronic field) offers unusual opportunities for trained radio engineers. Tri-State graduates in Radio Engineering can complete the Electrical course in 24 weeks. Courses also in Civil, Electrical, Mechanical, Chemical, Aeronautical Engineering; Business Administration and Accounting. Also short diploma courses (36 weeks) in Surveying and Drafting. Tuition, living costs low. World-famous for technical two-year courses. Special Preparatory Department for those who lack required high school work. Students from all parts of the world. 57th year.

Enter September, January, March, June. Write for catalog. *Burton Handy, Pres.*



TRI-STATE COLLEGE
1680 COLLEGE AVE., ANGOLA, IND.

Burroughs

CASH REGISTERS
LOW PRICES-EASY TERMS
COLORS TO HARMONIZE
WITH SURROUNDINGS

For a free demonstration call the nearest Burroughs office or write—

BURROUGHS ADDING MACHINE CO.
DETROIT, MICHIGAN

For Immediate Release

(Continued from page 29)

or their final prices but they will definitely be developed as quality items and ready about November 1st.

At the present time there are only slightly over a dozen broadcasting stations giving regular programs of frequency modulation and all pending applications for new stations have just been cancelled and must be replaced as soon as the Commission issues proper regulations, probably during the month of June. In spite of the great interest among broadcasters it is not likely that stations will actually be operating in many localities other than those in which experimental programs are now being carried on before the end of the year and under the circumstances it is impossible to foretell the number of receivers that will be sold. The actual popularity of these models will largely depend upon the sincerity with which all radio manufacturers who enter FM devote their energy to making it a quality product that will justify the interest of the public.

We do not plan advertising or promotional spotlighting of FM during the current year as such. When FM models are added to the Zenith line each of the units in the line will receive its share of special attention and the importance of each of the models in the line will be stressed with respect to the other models.

Meissner Reports Biz Gain

G. V. ROCKEY, Vice President of Meissner Manufacturing Co., Mt. Carmel, Illinois, reports a very encouraging gain in business during the first third of 1940. Sales for this period show an increase of 39.2% over the same interval in the preceding year.

An aggressive sales and advertising campaign is credited with a goodly portion of this gain. Consistent development and regular announcement of new products with wide sales appeal have also created their share of additional business.

In accordance with Meissner policy, these developments are being continued and expanded. Every new phase of the radio field is carefully monitored by Meissner engineers with an eye to the future needs of the serviceman, amateur and experimenter.

S-C Goes in on FM

Says Dr. Ray H. Hanson

THE recent action of the Federal Communications Commission in giving the green light to frequency modulation broadcasting on a commercial basis has tremendously increased the immediate profit opportunity of radio dealers, according to Dr. Ray H. Hanson, General Manager of the Stromberg-Carlson Telephone Mfg. Co.

"FM will stimulate the marketing of receivers more than any development in the past decade," he said, "particularly to those people who have purchased good receivers, and over a long period of time have been offered no improvement that would warrant buying a new radio. FM brings a plus service with reproduction so vastly superior to anything heretofore that it is of sufficient interest and value to create replacement buying on a large scale.

"When the FCC decision was made public there were pending about 130 applications for FM operating licenses. Most of the localities represented will have the staticless and improved tone of FM programs available this year. In the meantime, many other applications are expected. Wherever a station is placed in operation, a replacement market is opened for the dealers in that area. Those sections where frequency modulation is a future consideration are also FM markets for the shrewd American buyer will not buy a new radio that is apt in a year or two to become a relic."

Stromberg-Carlson pioneered with Major Armstrong in the design of FM receivers early last year, and there are more Stromberg-Carlson FM receivers in use today than any other make. These are all of the wide-band type, approved by the FCC in their recent FM decision. This extensive field experience with commercial designs of FM receivers places Stromberg-Carlson in an enviable position as the leader in this new industry.

Dr. Hanson estimated it would take from 5 to 10 years for a complete changeover to FM, but that cleared channel stations will continue as major stations to supply programs to those areas beyond the range of an FM transmitter. "FM programs with special appeal and different from programs on AM stations will help build up the FM audience,"

he said. "However, it will probably be at least a year before the new type of programs will demand the attention of a huge audience on FM. In the meanwhile, any radio purchaser must get a set which includes an FM band as insurance against early obsolescence."

Use of Ultra-High Frequencies for Aircraft-Control Seen

TO eliminate a hazardous condition which exists at the Los Angeles and Santa Monica, Calif., airports, the Federal Communications Commission today announced temporary authorizations for the use of the radio frequency of 272 kilocycles for controlling aircraft at these airports pending ultimate decision on applications by four airports in that vicinity and the prospective use of ultra-high frequencies for aircraft control. At the same time, the Commission temporarily granted the Union Air Terminal, at Burbank, and the Long Beach Municipal Airport continued use of 278 kilocycles.

This action was taken upon recommendation of Commissioner Paul A. Walker, who last month held hearings in Los Angeles on all four cases. Commissioner Walker points out that the Union Air Terminal and the Long Beach Municipal Airport have operated radio control towers for several years, sharing the 278 kilocycle frequency, which is the only one available at this time for such purpose. The Santa Monica and Los Angeles airports have attempted to control air traffic through the use of a light-signal gun. Witnesses for the Civil Aeronautics Authority and these applicants have shown that this is not satisfactory.

The maximum separation between any of the four airports is about 30 miles. Two of them are within 10 miles of each other. They are all busy airports. Statistics of the Civil Aeronautics Authority comparing these four airports with the 62 major airports in the United States show all four to be far above the average from a traffic standpoint. However, two of the airports, Burbank and Long Beach, which are separated approximately 30 miles, have used a common frequency with results mutually satisfactory. Santa Monica and Los Angeles airports have indicated that satisfactory working arrangements could be devised to make common use of a single frequency.

Expedition to Use Radiophotograph Service

PIONEER use of radiophotograph transmission from the antarctic, to relay pictures from Little America to the United States, is involved in the special temporary authorization granted Press Wireless, Inc., to communicate with the Byrd antarctic expedition. A1 (continuous wave telegraphy) and A2 (modulated continuous wave telegraphy) type emission will be used to control the pictures by air from the expedition base radio station, KTRK, to the Press Wireless point-to-point station at Hicksville, N. Y.

Compact Portable-Mobile Television Pickup Demonstrated by Du Mont

A PAPER and accompanying demonstration were presented the other evening before the Society of Motion Picture Engineers in session at Atlantic City, showing the very compact portable-mobile television pickup equipment of Du Mont.

The paper presented by Dr. Thomas T. Goldsmith, Jr. with Richard Campbell and Ward Stanton as joint authors explained the operation of the new and flexible synchronizing generator employed in this equipment. It produces the control signals to synchronize the transmitter and receiver for television operation over a range of line and frame frequencies up to 875 lines in contrast with the fixed lineage of 441 lines for pictures in use elsewhere in this country. The generated signal contains a radio frequency pulse for the vertical frame synchronizing which controls the number of pictures transmitted per second.

This entire field equipment is compact enough to place in the back of an ordinary passenger automobile and is part of the equipment for use in New York's newest television transmitter which is now being constructed on top of the 515 Madison Avenue Building. The field equipment will pick up remote events for relaying to the main transmitter which Du Mont is constructing for operation on television channel No. 4.

This field equipment was on demonstration at the Convention showing the compactness of the several small cabinets housing the synchronizing generator, the camera and the amplifying equipment to feed the high frequency relay transmitter.

The Federal Communications Commission recently licensed Du Mont to construct a new television station in New York City, and the equipment for this station is in keeping with the flexibility. *(Continued on 1st left hand column, page 56)*

HINTS & KINKS

Rotary Beam Turntable

An excellent turntable for supporting a rotary beam antenna can be made from the end plate and bearing taken from an old automobile generator. The armature laminations are removed as shown in the illustration and the shaft is securely fastened to the mast by means of one-inch iron straps. The antenna supporting frame work is bolted to the end plates.

Chasing Interference

Not all of the interfering noises which come out of a loud speaker are due to the operation of other radio stations, your neighbor's oil burner or the electric sign at the corner. Recently, severe interference was experienced to air-ground communication at one of our larger municipal airports. Although it was obvious from the nature of the interference that it was not caused by radio station operation, the Federal Communications Commission was requested to cooperate in the location of the sources, and was pleased to be in a position to do so.

After some investigation, the interference was located on the 11th floor of a building about two miles away from the airport. The machine causing the interference was a printing press equipped with a high tension device used to neutralize the frictional electric charge produced on the paper being printed. The actual source of the interference was a spark discharge in a defective high tension switch, which switch was connected with approximately twenty feet of unshielded wire. An adjustment made to the defective switch eliminated the spark discharge and the interference.

Filter Condenser Test

The following is a quick way to test for leakage on filter condensers. Merely place the suspected condenser across the "B" supply voltage for a second to give it a charge. Wait a second and then short the terminals of the condenser together. If there is a strong spark it is quite probable that it has very little leakage.

[Ed. note: *Use well-insulated clips. High charges are stored in condensers of good condition.*]

-30-

READ AND SEND CODE

Learn Easily at Home This Quicker Way

No experience needed. Beginners read code quickly, copy accurately. If at ready an op, speed up your wpm with this approved amazing all Electric Master Telex Code Teacher. Only instrument which records your sending in visible dots and dashes on specially prepared paper tape—then sends back your own key work at any speed you wish. Fascinating, foolproof—gets results because you learn by HEARING as well as SEEING. That is why thousands agree this method is surest and quickest. While not designated standard equipment, Telex is used at many U. S. Army Posts, Naval Training Stations. We furnish Complete Course, lend you the New All Electric Master Telex, and personal instruction with a MONEY-BACK GUARANTEE. Low cost, easy terms. Write today for folder RNB, no obligation.

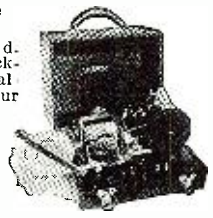

TELEPLEX CO., 67-69 Park Place, New York
In Canada write: **CANADIAN ELECTRONIC INST., TORONTO, ONT.**

bility which is necessary to provide rapid progress in television transmission methods without obsolescence of the transmitting apparatus or of the receiving equipment purchased by the public.

The cooperation between *Du Mont Laboratories* as an engineering firm and *Paramount Pictures* as a company well versed in the art of public programs and entertainment, promises an excellent service from this latest addition to the New York television transmitting group, and this portable-mobile equipment, which was demonstrated, is an essential element for providing varied programs as well as providing varied transmission systems for public test and approval.

Post Graduate Servicemen Courses

THE first of a series of Annual Post Graduate Courses for experienced Radio Servicemen will be held in Jackson, Mississippi, July 15-27 inclusive.

The course is being arranged by Harold Davis, writer and designer, under the sponsorship of testing equipment and parts manufacturers. It is for the purpose of making good radio men better. No tuition will be charged but no one will be accepted who is not a graduate from some radio school or who has not had two years' experience in the field. In addition, applicants must have letters of recommendation from some legitimate jobber with whom they have done business.

No elementary work will be included, and those who are "rusty" on their fundamentals will have to brush up beforehand.

The school will last two weeks during which time 36 lessons (3 per day) will be given. These lessons will be presented by engineers from the various manufacturers, but the lessons will be in a progressive order, the speaker being assigned a subject in advance to the meeting. Talks on "How to get business" and even on bookkeeping will be included. A quiz will be given each day, and final examination the concluding day. Those making passing grades will be awarded diplomas signed by the instructors.

Notes on Marine Receiver

(Continued from page 37)

alleled and provided with a plate circuit RF choke effective over the 315-285KC band. One or the other grid-to-ground circuit might be provided with a manual trimmer capacity so that an accurate adjustment for balance against a null might be effected. The arrangement would suggest in effect an RF stage or pre-selector.

Another would be straight inductive coupling between the loop and the long wave antenna coil. A push-pull primary for the latter coil would be required, and this would involve its removal from the band-switch and its considerable reconstruction before replacement—not to mention certain patent input circuit complications if switch-over facilities for optional antenna input on the long wave band are to be in order.

—50—

Ring the Bell

(Continued from page 23)

If you will, send me *your* figures and if we get a sufficient number, we will publish them in chart form in a subsequent issue. Then you can compare yours with the other fellows'.

Send:

1. Total number of hours worked during last twelve months.
2. Total expenses *less* those for parts, tubes, sets, other sidelines and labor for that period.
3. Total number of sets serviced during that period.
4. Total number of *charged* hours during that period.
5. Population of town in which you have your shop.

If you haven't these figures available you had better start right away to have them for this time next year. Their proper use is a sure way to "Ring the Bell."

—50—

Serviceman's Experiences

(Continued from page 20)

sure it was not grounded, I used a circuit tester. It was, but instead of being discouraged, I was secretly happy; I had heard so many times a grounded car antenna could be cleared by putting a voltage across it that I was glad such a case had come my way. It would have been too troublesome to get a 120-volt line from the shop, so I used the storage battery. Realizing the danger of fire, I filled a bucket of water and stood it behind me. Then I touched the lead-in to the battery post. Nothing happened. Nothing, that is, except that the dome light went on. Such things are very fatiguing. As I stepped back I put my foot in the bucket.

Well, there was no reason why I should take the roof upholstery down, so—after I had tried several stock an-

tennas, and estimated the old set would require one between 45 and 50 feet off the ground, which would be objectionable if the customer ever went through the Holland tunnel—I put some ordinary aerial wire between the front and rear axles. Plenty of it.

The set wouldn't play when I first turned it on, but I located the trouble quickly—a burned-out tube. Luckily, we had one left in stock; I used it and took the car out for a trial spin. Wasn't bad, really. A few stations had enough volume to be heard above the normal squeaking level of the body. Of course, ignition noise was bad all over the scale; but that part wasn't my fault—the fellow who removed the set from the first bus must have overlooked the suppressors and bypasses. I was afraid the customer might squawk if I raised the price *too* much, so I didn't put any new parts in.

Outside of a flat on the way back to the shop (the spare was locked, and I had to cough up fifty cents to have it patched) there was nothing standing in the way of delivery. The customer was waiting impatiently.

I very pleasantly explained the extras which had been necessary.

"The antenna doesn't look very neat," I admitted, "but you'll find it doesn't hit the bottom of the car except when you go over the highest bumps. You will soon learn to avoid them."

"Here's your three dollars," he replied, climbing into his jalopy. "That's what we agreed upon!"

"But the extra parts, and the extra time?" I asked.

"You should have *deducted* for the extra time," he told me, "because you didn't keep your contract, and kept me waiting. If you're not satisfied, I'll come back later to argue it out with the boss!"

"Well—ah—I don't think that will be necessary," I stage-laughed.

When Al came back and saw me sitting in the shop, greasy, perspiring, and staring into space, he remarked:

"You certainly get more out of a blank wall than anyone else I've ever met. Do any business while I was out?"

"Three bucks," I replied weakly, pointing to the top ticket on the spindle, "for an auto radio installation."

Al looked me over carefully, noticing the spots on my clothes which later cost me \$2.75 to remove, and said:

"Next time it happens, run for the nearest bomb shelter!"

After that, all I had to do was to go down the block and buy a new tube from *Redoubtable Radio Repairs, Inc.*, so Al wouldn't notice the one I'd taken from stock.

You might think it foolish to pay all that extra money out of my own pocket just to keep my partner quiet. But if you knew how Al sounds when he starts telling me how to bid on a job, you'd do the same thing. That guy has a tongue like a knife.

—50—

First with the news!
RADIO NEWS
Read it every month!

The New
TURNER
Microphone
Models

Turner HAN-D

9X Crystal 9D Dynamic

- Hold It! • Use it on desk
 - Hang It! • or floor stand
- One microphone, suited for voice, music pick-up or auto use. Positive contact slide switch permits off-on operation. Rich brushed chrome finish. Fits any 5/8-27 stand. With 7 ft. removable cable set, diagrams and chamoisette mike bag.

9D Dynamic HI - Impedance.
List. \$25.00
9X Crystal. List. \$22.50



Turner
"Challenger"

CX-Crystal • CD Dynamic

Challenges comparison in performance, appearance and price. Rich brushed chrome finish. For the man who must get the most for his money. With 7

ft. cable and diagrams.
CX Crystal. List. \$15.00
CD Dynamic, HI Impedance. List. \$16.50

U-9S Multiflex Fills 50 ohms, 200 and 500 ohms and Hi-Impedance Requirements

Simply twist the switch shown here on U-9S, to change impedance. Semi- or non-directional operation. Level -52DB at hi-impedance. Free from peaks and holes from 40-9,000 cycles. Dignified gunmetal finish. Packed with diagrams, 25 ft. cable set, and chamoisette mike pouch. List. \$35.00

Write for Full Information on these models

Crystals Licensed Under Patents of The Brush Development Co.

908 17th St. N.E.

Cedar Rapids, Iowa

THE **TURNER** COMPANY

What's New in Radio

(Continued from page 29)

size of the modernistic cabinet, only 8"x8"x16". Panel controls are reduced to a minimum, making operation easier than a home radio. Normal channels supplied are: Coast Guard, Telephone, and Ship-to-Ship.

Reception is provided on all channels in the Junior model, transmission on any one channel. A press-to-talk key permits the unit to receive and transmit. Cabinet size is only 8"x8"x12", making the set ultra compact.

Either set may be had for operation on 6, 12 or 32 volts with low battery drain. Special emphasis has been given to moisture-proof construction guaranteeing long life and dependable service.

The cabinet and other metal parts are treated with a baked wrinkle-grey enamel trimmed with chrome and red, supplying a most attractive and durable finish, in fitting with all boat interiors. A horizontal chrome speaker grille inset with red plastic completes the modern appearance. The DeLuxe model boasts chrome carrying handles also trimmed with red plastic.

The remarkable value given in SHIPPHONE sets has been made possible by careful design and forethought, just as modern engineering has perfected inexpensive home radios which a decade or so ago cost several hundred dollars.

Other models are available with 25, 50, 100 and 250 watt ratings. Two high power units rated at 500 and 1000 watts are also available.

Microphone modernization is offered by the new *Atlas* Sound "Break-In" Switch which offers on-off or press-to-talk operation. Button is pressed for press-to-talk operation, and turned for on-off switching. For all microphones or circuits having single conductor shielded cable connections. Completely wired and can be instantly attached to microphone; chassis connector; or anywhere in the microphone cable line by using a male and female connector. Solid brass construction with "Super-Chrome" plating. Inner noiseless contacts made for "lifetime" use. All threads $\frac{1}{8}$ "-27, allowing use with *Atlas* "Hold-Tite" Connectors and others. *Atlas Sound Corporation*, 1448-39th Street, Brooklyn, N. Y.

Raytheon is pleased to announce the addition to the receiving tube line of several new types. These are briefly described below.

1D8GT is a 1.4 volt battery type with the ban-tam construction. This tube has a diode, a triode and pentode to perform the functions of detector, audio amplifier and power output stage.

61B5 6.75 replaces the type 6AB5 and 6N5. A T9 bulb is used and the electrical characteristics have been designed to retain the sensitivity of the 6AB5 together with the extended cutoff of the 6N5.

6AL6G is a 6.3 volt type designed for use as an amplifier in television receivers. The char-

acteristics are similar to those of a 6L6G but the plate load is brought out to a top cap to allow a high momentary peak voltage rating.

7H7 is a high mutual conductance pentode which has been designed to have as wide a cutoff as is consistent with a good ratio of GM to plate current. This tube has a 2.0 watt cathode in place of the usual 3.0 watt cathode used in other high GM amplifier tubes and hence may be used in series with other 2.0 watt cathodes. This new type will find application in untuned RF circuits, wide band, high frequency amplifiers and other equipment where the high GM characteristics are desirable.

35Z6G is a twin diode rectifier designed for use in voltage doubler circuits in AC-DC receivers. It is characterized by a plate current rating of 110 ma. which is somewhat higher than similar ratings for other voltage doublers such as the 25Z6G.

50Z6G is a 50 watt power amplifier with characteristics like those of the 6Y6G. The high heater voltage makes this tube very suitable for use in AC-DC receivers.

70L7GT is a dual section tube containing a half wave rectifier and a beam power amplifier. *Raytheon Production Corporation*, Newton, Mass.

Two new record players—wireless and wired—have been announced by the *General Electric* radio and television department, Bridgeport, Conn., which may be used with any type of broadcast receiver and which represent in their design several improvements in this relatively

new form of expanded radio services in the home. Having the effect of converting practically any standard receiver into a phonograph combination, with all of the advantages of electrical reproduction, the new units lend themselves particularly to warm weather entertaining.

General Electric's new wireless record player, model JM-23, features an entirely self-contained radiating capacity antenna which is not directional and which broadcasts in all directions. This development eliminates the necessity of changing the position of the player to get maximum transmission over the radio. An easily accessible adjustment, through a hole in the bottom cover, changes the frequency of the wireless record player signal, adjusted at the factory for approximately 1500 kilocycles, but which has a range well over 1200 to 1600 kilocycles. There is a three-position power switch. In one position the player is off; in the middle position the oscillator and motor driving the turntable are turned on; while in the third position the motor is turned off for changing records without allowing the tubes to cool. The modulator is permanently adjusted at the optimum value for best quality transmission, and volume through the radio loudspeaker is then controlled by the volume control on the radio. This prevents overloading and distortion in the transmission of recorded sound.

The wireless player need only be plugged into any alternating-current outlet in any room in the house. There are no wired connections between player and radio. The cabinet is attractively styled in American walnut with a deeper tone walnut band. The top of the lid is center matched butt American walnut and the entire cabinet is hand-rubbed and polished. It will play either 10- or 12-inch records with the lid closed. A crystal pick-up and tone arm provide high quality reproduction. A two-tube circuit, oscillator modulator and rectifier, provides hum-free reproduction. The tubes are readily accessible when the bottom cover is removed. The electric motor is cushion-mounted, and is self-starting. The turntable is driven by a friction drive located on the inside of the turntable rim. The new record player has Underwriters' approval and its approximate operating cost is 1/8 cent an hour. In size it is slightly less than 15 inches wide and 11 inches deep, and is 6 1/4 inches high.

Featured in the new line of *Atlas Sound* "Morning Glory" Type Double Re-entrant Projectors the Model DR-42 with a 3 1/2 foot exponential air column. The DR-42 has a frequency cut-off at 140 cycles, and a projection angle of 80°. Overall length 17 1/2". Bell Opening 21".

Model PM-23 "Dyna-Flux" Compression Speaker Unit used with the DR-42 is a permanent magnet type with a power rating of 18 watts, v. c. imp. 15 ohms.

Outstanding feature of the "Morning Glory" Projector is the 100% weather protection. Con-



struction is compact, non-resonant; while the exponential design offers high efficiency and sharp directional characteristics. Mounting bracket supplied as complete equipment.

Model DR-42 "Morning Glory" Projector \$20.00, Model PM-23 Unit \$30.00. *Atlas Sound Corporation*, 1448-39th St., Brooklyn, N. Y.

A line of general-utility voltage-dropping resistors is announced by *Clarostat Mfg. Co., Inc.*, 285-7 N. Sixth St., Brooklyn, N. Y.

Series HT units are now available in any re-

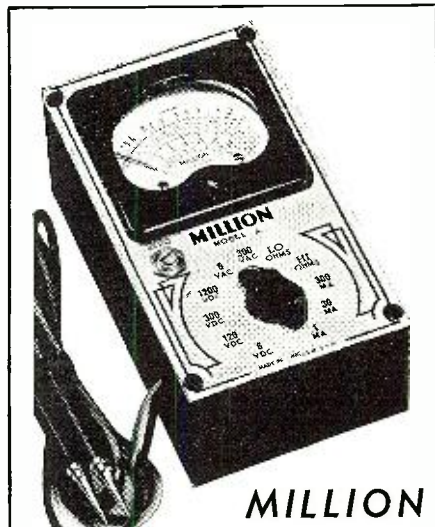

MILLION AC-DC MULTIMETER

- Sensitivity—1,000 ohms per volt
- Volt D.C.—0-6-120-300-1,200
- Volts A.C.—0-6-300
- D.B., —10 to +12
- M.A.D.C. — 0-1-30. 300
- Low ohms—0-2,000
- High ohms—0-500,000
- Zero Adjuster same for both ohm scales
- Self Contained Battery
- Built-in Test Leads
- Size 2x3 1/4 x 6
- Shipping Weight 2 Pounds

DEPENDABLE ECONOMICAL CARRYING CASE \$1.50 **\$8.45** NET

If Your Jobber Cannot Supply, Write Us
MILLION RADIO AND TELEVISION
577 No. Union St. Chicago, Illinois

FREE 172 PAGE CATALOG

EVERYTHING IN RADIO
At Lowest Prices!

YOU NEED THIS BOOK!
Get your ALLIED Catalog now! You can't afford to be without it if you're a Serviceman, Dealer, P.A. Man, Amateur or Builder! It's the biggest, most complete Radio Catalog out today—your Guide to real money-savings.

60 New Sets, Real Radio hits—new "Camera" and 3-way Portables; new European reception compacts; plastic phonoradios; home recorder combinations; amateur radios, etc.

18 New Sound Systems—7 to 75 watts—Orchestras, Schools, Churches, etc. New ideas—new applications—new low prices—Time Payment Plan—15 Day Trial Offer, etc.

Servicemen. New Test Equipment—new tools and gadgets—more than 15,000 quality replacement parts. Big Special Bargain Section saves you money!

Builders. Count on ALLIED for all the new kits and builders' supplies. You can depend on ALLIED as your Radio Supply Headquarters because ALLIED is the 100% Radio House that's at your service.

ALLIED RADIO CORP.
833 W. Jackson Blvd., Dept. I-H-O
Chicago, Illinois
Send your FREE 1940 Radio Supply Catalog.

Name

Address

City.....State.....

sistance and wattage rating from 100 watts up. They can be used for any voltage-dropping or current regulating purpose, such as the operation of 110-volt equipment on 220-volt supply, the dimming of photo-flood lamps, the operation of soldering irons and electric motors, and so on. A Clarostat Greenohm power resistor is the heart of this device. It is housed in a 3-inch diameter perforated metal shell $4\frac{1}{2}$ inches long, with mounting feet, for the 100-watt size, finished in high-temperature baked-enamel. Units are available either with short connection cord and female Edison receptacle, or again with male and female Edison receptacles.

A recent development in P.A. is the new *Knight* 30-watt amplifier. This unit features an RCA record changer which operates from 6 volts or 110 volts A.C. Amplifier Specifications: *Output*: 30 watts usable power (37 watts peak); hum is inaudible (63 db. below rated output); *Output Impedance*: 2, 4, 6, 8, 16 and 500 ohms on speaker selector switch; *Input Channels*: Four, two for high-imp. mikes, each with individual volume controls, two for phono on fader control; *Tone Controls*: Two, attenuator type, one for treble, one for bass; *Gain*: On microphone, 135 db., on phono, 80 db.; *Frequency Response*: 30-12000 C.P.S. (on amplifier); *Tubes*: 2-6J7, 1-6N7, 1-6L7, 1-6C8G, 2-6L6G, 2-6X5G; *Line Drain*: 141 watts A.C., 24 Amps. D.C.; *Standby Switch*: To conserve battery drain; *Amplifier Size*: 20 $\frac{3}{4}$ " x 13 $\frac{3}{4}$ " x 15". For operation from 6 volts or 110 volts A.C. ALLIED Radio Corporation, 833 W. Jackson Blvd., Chicago, Illinois.

Talk-A-Phone Mfg. Co., 1847 S. Millard Ave., Chicago, has just released a new line of paging system power amplifiers with built-in speakers, for use in conjunction with standard intercommunication master stations. These new power stages are available in 5 watt and 15 watt sizes, and are ideal for paging and call purposes in factories, warehouses, hotels, out-of-doors, or wherever there is a high noise level. Any number of these power stages may be connected together, operating off one channel of any intercom master

station. Units can take care of extra speakers. Larger cabinet in illustration is of complete power stage amplifier and speaker; smaller cabinet

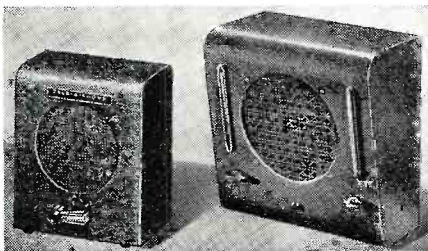

is a special communicator unit that permits the person being paged to answer the master station.

Volume controls with serrated shafts, for quick and exact replacement of controls having the knurl and slot shafts, are announced by Clarostat Mfg. Co., Inc., 285-7 North Sixth St., Brooklyn, N. Y. These Series KS controls are of the popular Clarostat midget type, and permit

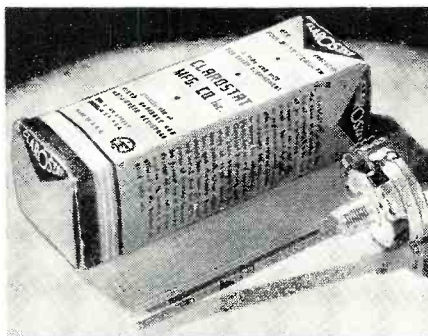

replacements without having to replace the slip-on knobs as well. Series KS units are available in all required resistance values, although only six values are required in servicing the bulk of existing radio sets.

The problem of high-power amplifier systems for coverage of large outdoor areas with minimum equipment investment is solved by the Lafayette Model-485T Booster Amplifier just announced by Radio Wire Television Inc., 100 Sixth Ave., New York City.

Capable of 50 watts normal output (75 watts on peaks) this booster, or several of them if desired, can be driven to full output from any public address or other amplifier capable of 1.73



volts output. Because the Booster is a purely voltage actuated device, adequate drive for full output may even be obtained direct from an external preamplifier. Perfectly filtered operating power for such an external preamplifier is provided by the booster.

The tubes used are a 6CSG phase inverter, 6CSG push-pull driver, four 6L6G's in the output stage, and an 83 rectifier. A single high-impedance input channel is provided, with six outputs ranging from 2 to 500 ohms for complete flexibility in matching in any desired speaker load. This matching is made non-critical through inclusion of 10% inverse feedback.

Among other features of this unit are: 85 db. gain, hum level -61 db. below 50 watts, frequency response 40 to 12,000 cycles. The unit is available in both table and rack types.

A unit such as described here quickly converts any low-power system to high power applications; a distinct asset to the sound man who goes in for rentals but who cannot afford to invest in a complete high-power system when prospects for such rentals are relatively few and far between.

Utility Radio
(Continued from page 18)

for police communication is the PR Series station receivers which are made for operation on any one frequency from 1600 Kc. to 40 Mc. All employ crystal controlled oscillators, squelch and noise limiter circuits. A complete line of mobile receivers is also available in this series.

Marine Radio

MARINE RADIO SERVICE, Inc. of Wilmington, California, have just added another transceiver, Model 75-X, to their fine line of highly efficient radiotelephone

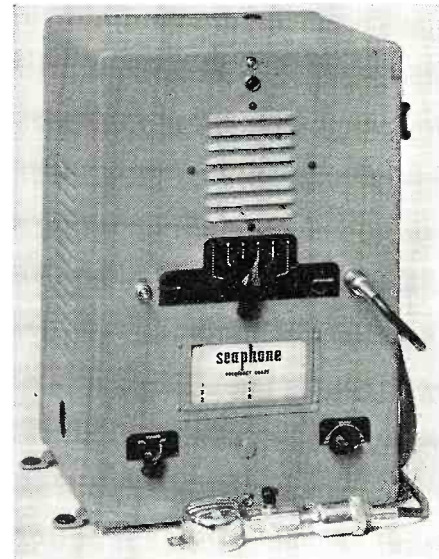

equipment. This model is a complete crystal controlled job on 6 frequencies for both transmitting and receiving which makes it as near fully automatic as is possible. A specially designed background noise eliminator permits the receiver to remain quiet when no signals are on the air. There is also provision for automatic bell-ringing attachment which is used when considerable traffic is carried on between ship and shore. This attachment permits the coastal harbor telephone station to call the ship on its own number by means of a bell similar to the one on the telephone at the home, thereby making unnecessary pre-arranged schedule or tuning in the shore station to determine if calls are waiting for transmission.

Aviation Radio

TAYLOR AIRPHONE PRODUCTS at Hangar 15, Long Beach Municipal Airport, Long Beach, Calif., have brought out a new portable transceiver especially adapted to the single-seater sport planes where weight

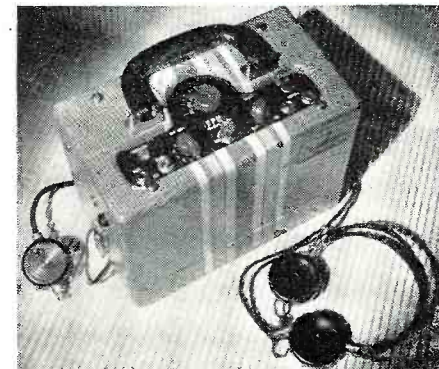

and compactness are of the essence. The Model APR-5 contains five of the latest type high-gain tubes which give a dependable Aircraft Beam Range with the plane antenna of approximately 150 miles. It also gives a complete coverage of Airways Beam, Traffic control and Marine Direction Finder Band as

Solar Condenser QUICK-CHECK
Spots "bad ones" while set is operating
Quick as a Wink
Write for Bulletin QC
SOLAR MFG. CORP. Bayonne, N. J.

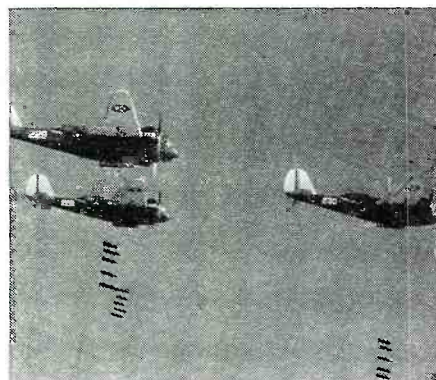

LOOK OUT BELOW!

It's open season over there

Bombers are going to town literally and colloquially over war-torn Europe! In an authoritative article, James L. H. Peck, author of "Armies With Wings," brings you an up-to-the-minute account of modern bombing operations: methods of bombing; types of "eggs" used; charting the attack; sights; and types of bombers. Read this great article and you'll know why the modern bombing plane and the "eggs she hatches" upon military and helpless alike make her more to be feared than any other of man's weapons!

AUGUST ISSUE

FLYING AND POPULAR AVIATION

ON SALE AT ALL NEWSSTANDS!

well as Standard Broadcast. It has a built-in loop antenna sufficient for local reception and because of its directional qualities permits accurate aural-null direction finding.

There are many practical innovations built into this 6 by 11½ by 10 inch transceiver some of which are a head-phone jack for a rear cockpit passenger who can hear the pilot's conversation with the airport, a snap-switch which cuts out the variable tuner and automatically cuts in the beam frequency and a radiation bulb to show that the signal is "going out." The case has space for all the batteries which are of standard make and will give approximately 250 hours of dependable operation. The weight is 15 pounds complete.

A NEW radio assembly has been developed by *United Air Lines* and now is being installed in all the airline's planes.

The assembly includes a switchboard which makes the complete radio facilities of the plane available to the pilots merely flicking switches and a radio rack which saves 75 to 100 pounds in weight.

Despite the fact radio is an important accessory in air transport operation, no provision is made for it in the construction of transport planes. Thus, the airlines have

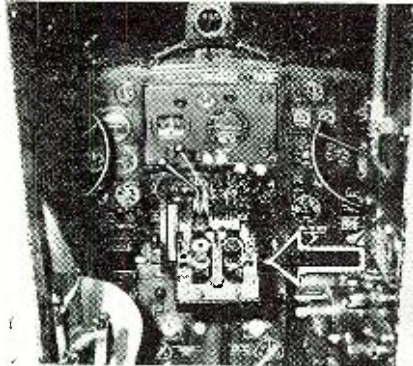

scattered radio switches at various places in the control cabin and installed radio transmitters, receivers and other apparatus on shelves in the various cargo compartments, or wherever they could find a spot.

The radio switchboard was devised by P. C. Sandretto, superintendent of *United's* communications laboratory in Chicago. The radio rack was designed by A. F. Trumbull, foreman of *United's* radio electric shop in Cheyenne. The combined device represents the first weight saving apparatus since the introduction of aeronautical radio, according to J. R. Cunningham, director of communications for *United*.

The switchboard, which is as simple to operate as a telephone switchboard is a dual output system which simplifies radio operation aloft to the flicking of a switch. It is located on the control column within arm's reach of both pilots. No adjusting is necessary and none of the switches have contingent operation so that any or all may be operated by one pilot in any combination desired without change of volume or facilities in the headphones of the other pilot.

The transmitter, the communications receiver, the marker beam receiver, the radio range, the beat oscillator, the directional loop antenna, the auxiliary receiver and even the telephone connecting the pilot's compartment with the stewardess, galley, all are operated through a single control panel only 8 inches square. Volume controls also are located on the same panel and these are painted in colors to correspond with the colors used for the various radio switches so as to make the desired volume control easily identifiable.

The radio rack centralizes all of the planes radio equipment in one assembly. It is located in the left cargo compartment, thus leaving the right cargo compartment completely free for baggage, express and other cargo. The electrical junction box is distributed along one side of the rack and this is where the saving in weight—always important in airplane operation—is achieved. About 75 pounds is saved in the wiring alone because heretofore the electrical junction box was located in one side of the plane with wiring extended to jack boxes and

shelves hooked overhead or installed wherever spare space could be found any place in the airplane.

Both the switchboard and the radio rack have been built with space prepared for contemplated future equipment like the ultra high frequency receivers, instrument landing systems and so on.

Facsimile Radio

THE *New York Post*, whose recent work creating a new style of newspaper typography has caused widespread comment in the journalistic field, is cooperating with the *Radio Corporation of America* in the publication of an experimental radio facsimile newspaper in the *RCA Exhibit Building* at the *New York World's Fair*.

Carrying the *New York Post's* masthead, the facsimile newspaper is published daily in full view of the thousands of visitors to the *RCA Exhibit*. A miniature front page, the paper measures 8½ x 12 inches per sheet



and presents the outstanding news of the day in condensed form. A sheet is run off every ten minutes, which is more than twice as fast as could be done a year ago.

"This experiment and demonstration," according to David Rosenblum, general manager of the *New York Post*, "gives the public a glimpse into the future when newspapers may be printed in the home by radio. We recognize the possibilities inherent in radio facsimile broadcasting and are particularly interested in studying the special technique required by the new medium."

The *Post* has assigned two rewrite men to select and condense the news. Working with them are a compositor and a special make-up man. The editions are put together at the newspaper plant and rushed by special messenger to the exhibit building at the Fair.

Professional Radio Accessories

DOO LITTLE & FALKNER, Inc., 7421 Loomis Blvd., Chicago, Illinois, have developed a direct reading frequency monitor, the FD-8. The outstanding features of this unit are: direct visual reading, temperature

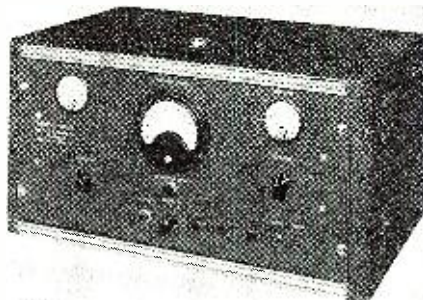

controlled crystals, and single unit construction.

The unit consists essentially of a radio frequency converter tube operating in conjunction with an integral crystal controlled oscillator which heterodynes the signal being monitored producing an audio beat note. This note is amplified and applied to an electronic counting device which produces a direct indication of frequency deviation on a meter. The meter scale is calibrated from 0 to 1000 cycles per second. A switch with

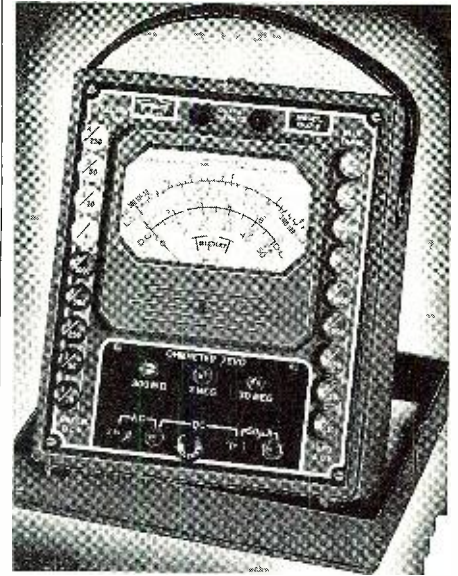

TRIPLET

MODEL 1200-F

\$27.84

An Entirely Automatic Volt-Ohm-Milliammeter with Push Button Testing. Only one button need be pressed for any range and test setting. 25,000 ohms per volt DC, 1000 ohms per volt AC . . . Ranges as follows: DC Microamperes 0-50; DC Milliamperes 0-1-10-50-250; DC Volts 0-10-50-250-500-1000; AC Volts 0-10-50-250-500-1000; 0-500 low ohms; 0-300 M—3 Megohms—30 Megohms. Separate zero adjustment for each ohms range and self-contained battery for ohmmeter . . . Dealer Net Price . . . \$27.84

MODEL 1200-A

Contains separate AC and DC instruments in tilting case, accuracy of each within 2%. Two RED • DOT Lifetime Guaranteed Instruments . . . Sturdy Portable Metal Case with black suede enamel finish . . . Dealer Net Price . . . \$21.84



MODEL 1232-A

Triple Shielding . . . Improved Attenuation . . . Large Dial Opening for improved readability, with direct geared dial . . . Six Bands covering frequencies from 115 Kc to 30.5 Mc. All frequencies fundamentals . . . Scale length over 50 inches . . . Dealer Net Price . . . \$29.84



MODEL 1213

Sockets to test all present day tubes including Bantam Jr., High voltage Series tubes including 117Z6G and 1.4-volt Miniatures. Ballast Tube Continuity Test . . . Foldex Tube Chart . . . RED • DOT Lifetime Guaranteed Instrument . . . Dealer Net Price . . . \$22.00



Write for Catalog—Section 158, Harmon Drive

TRIPLET ELECTRICAL INSTRUMENT CO.
Bluffton, Ohio

multiplier indications extends the range to 5,000 and 10,000 cycles per second. Further specifications include: Range—1.6 to 50 MC; Accuracy—0.002%; Stability—0.001%; Deviation range—0.10,000 cps in 3 ranges. Full scale readings are 1000, 5000, and 10,000 cps. Accuracy of readings: 2% of full scale; power consumption—75 watts at 110 v. 60 cycle AC.; weight 26 to 40 pounds depending on the type mounting.

Concetric transmission line has long been a leading product of *Doolittle & Falknor, Inc.* Lines of the copper tube type have been supplied by them for use in every conceivable

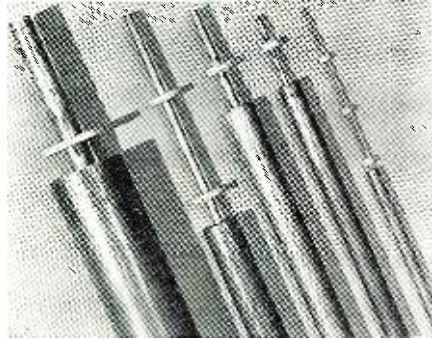

radio service in both government and private enterprise. Practically any requirement for material of this type can be furnished from the standard line which comprises a large variety of line sizes and fittings for every application.

Hamchatter

(Continued from page 35)

LISTEN. Old Timers, and you shall hear; The latest dope of this year.

W1 Old Timers' here's the latest dope from the city of a thousand hams, Detroit, giving you the info on the State of Michigan.

W8JAH, *Century Club* member, who once was on 10 and 20 meter fone and c. w. wid pp 234's es *IRRO*, is now using a 16 watt rig on 160, 80 and 40. He now has an *HQ 120A*.

W8SZE (Sam, Zeke, and Eddie), tore apart his fone rig and expects to go on 80 c. w. He may go to Wayne University.

W8S2S (Sam, Zeke, and Sammy's little brother), has connected the screen and plate together to get more power from his ECO. HI!

W8NJP, who is also a *Century Club* member, has a 150 watt rig, using *HK 24's* on 2 1/2 meters. W8TEM and W8SNN are also active on 2 1/2.

Gosh, W8P8B's *XYL* sounds nice over the air. She may give up knitting for ham radio (the hopes).

W8RMH es W8QDU are about the most active in ham contests around Michigan.

W8OTE, W8LOH, and W8TUX expect to go on 10 fone soon. (The Motor City has plenty ignition noise.)

The *Michigan Emergency Net*, who drill every Sunday morning on 3930, are really getting some place these days. They are getting cooperation from the *Michigan State Police*.

Note: Hams who have rotary beams, better make sure their beams have low wind resistance. Many a Michigan ham had his beam come down during a fifty mile an hour wind, about January 10.

W8KUU, who fell off a roof putting up a 20 meter vertical, is getting much better.

W8R2S is off the air because he needs a mike battery.

W8GHV and W8WR know more about beer than any hams I know. They get a kick out of testing different brands.

W8OTE raises birds in addition to his hamming.

W8RHI is being troubled by a certain bel who cuts his antennas down and knocks on the window of his shack at 2:00 a.m. while Lou is working DX on 160.

W8HN, of Garden City, expects to use a 60 watt Mazda lamp as a quadrupler in his new rig. (More power to you.)

The loudest 20 meter out-of-the-state signal that comes into Detroit is W1DSY. Don't see why he complains about standing waves on the feeders of his *400*. Every time he modulates, the detector circuit at W8UFH arcs over.

W8UFH says, "You can always tell an amateur YL by her characteristic curves."

WELL, hr we are with more dope on the fellow-fer has got most of us down, but then there is the dx contest, keeping most of the boys busy.

Speaking of spring, W8OTE is practically surrounded by canaries, having about over 100 of them which he is raising. Them birds must cause lots of QRM when they get going, hi.

W8MXU had the unfortunate circumstance of being interned in a hospital where he underwent a stomach operation. We offer our condolence and hope he is well on the way to recovery.

W8LEC the dx hound, made a flying start in the dx Contest, having at the time of this writing about 681,000 points to his credit. He has so far contacted 163 stations of which 111 were foreign. Well gud luck ob.

W8TEM is going in for some 112 megs activities, so are quite a few of the other hams beginning to get interested in 112 megs.

W8SJL is still having trouble of finding the right kind of antenna for 75, has tried all kinds with no success. Why not try a good one for a change ob, hi.

W8SCHA has a new small power cathode modulated rig going on 20.

Must be the height of something or other or is it just a clever idea in the unique system that W8LZY devised. Being a member of the *Malted Milk Net* and to save time in listening for members of the net to come on, he rigged up a signaling system which lights up a red light when any of the net gang are on the air on the net frequency of 1875 kc. Maybe next we will have a signaling system that will tell us when someone is calling us, hi. Ham radio marches on.

W8FWT will hereafter confine his radio activities to ham radio, having given up commercial radio now that Uncle Sam has given him a steady job.

W8UJL in Centerline, Mich. is a new call being heard on 160. He also is putting out a nice sig.

W8BWB is having trouble with his new 20-meter vertical, just can't seem to get it to work. Well, hope he has all the bugs ironed out by now.

W6CIS, *SCM* and W6RBQ, *EC*, of the San Francisco *ARRL* Section each gave talks before the *Marin Radio Amateurs* on Jan. 12th. They explained the whys and wherefores of their respective jobs.

W6KNZ is a traffic handler on 160 fone and is a member of the "Mission trails traffic net." He is looking for California traffic and can give fast service to all California points.

W6SG was the winner of the big prize at the

Marin Radio Amateurs Xmas party (A Gala Affair). The prize? "How to get on the air in one easy lesson."

W6RAK's Jr. op didn't want a remote control electric train for Xmas. We wonder if RAK will now give up Ham Radio and go in for model Railroadings?

W6QJN and W6HVX are charter members of the *M.A.B.D.* which isn't a new government agency but only means "My antenna blew down." Wonder how many hams are eligible for membership?

Ask W6JTP about the time he got into a jam by telling some lug on ten fone about the swell fishing he had in a private pool and then discovered that the lug he was working owned the pool. Oh, me!

W6BIC, who works 75 fone, says those new "Hetrofils" certainly cut down the qrm. By the way, W6BIC is located in Nevada. Anybody need Nevada for "WAS"?

W6DKS moved to new location in the same burg and claims he is getting out better.

W6ITH, world known fone man, has joined the *Northern Calif. AARS Fone net*.

W6PHF put up his new beam with the aid of W6CC and W6CBB. They had to cut off the top of the tank house in order to install it, thereby causing PHF's *XYL* to go on the war path. Guess it's going to be a long time between visits now.

W6LLV working portable in El Centro until the lettuce season is over. He is boss man of the well known *Central Calif.* traffic net.

W6MBR is now located in Oregon and we expect he will be sporting a W7 call soon.

W6MGR is a glutton for activity. He is active in the *San Francisco Radio Club*, the *American Legion* emergency net and the *AARS*.

W6ONX manages to keep busy by operating with the *AARS*, the *NCR* and the *Central Calif. TFC* net. Spends most of his time on 80 meters.

W6PGB had his hands full handling holiday traffic thru his sked with PI on 40 meters.

W6NQB, formerly of SF, is now located in Tacoma, Washington, and sporting the call W7HXK on 75 Fone and 80 c. w.

W6MXE says he is glad that they have a new baby. Now he can easily find a safety pin to replace the missing buttons on his shirts.

W6FYR is on 40 and 20 at times but is very busy with his traffic and trunk lines on 80 most of the time.

W6AFL is now working portable out of Miles City, Montana. Works 80 and 160.

W7CMB finds that a night job really does interfere with hamming but he did get on for the sweepstakes and ran up a score of over 75,000 points. A nice score for a busy man.

W7GEK finds that his new SX16 is the real thing and just what he was looking for.

W7GJN kept blowing out 6L6's until he got his modulator to work. That's one way of finding the trouble, but kinda expensive.

W7ABO works both 160 fone and 80 c. w. W7LD joined the *AARS*.

W9PDH tuk his rig dwn to Rotary Club meet an' showed the Rotarians how it perked. Demonstration was "successful." HI.

W9RWV—radio's worst varmint—was hitched last yr. Honeymoon must be over as Don is now at it agn wid abt 400 W on 160F. Incidentally I coined the expression "One Six Nuthin'" which is used a lot out this way nw wen we mention 160 M band. Hi.

W9RAM the big bad sheep fm Clearwater is a new Uncle which kept him off air for while as "shack" was used for nursery so if this infant grows up wrong es becums a radio op. U Hamchatter readers R rite-nw in on the secret.

Our well liked W9WBX Lloyd of Gibbon had a nice visit from W6KNN. Last time I was QSO wid Max W6KNN we wrkd Alaska. Max's father (also a "ham" whose call I have forgotten lives in Gibbon es wrks 80CW. W9WBX told me W9GMP who used to live there also, is now delete, es living in west end of our state. Max wrkd ZL2BN on 75 a yr ago. To bad nations "must" fite! And, hadja hrd old W9-WWV—wiggie wobble es wibrate— is a new "poppra"? Lil YL. Mani of U readers recall ol' low-voiced Bennie when he op'd fm Juniata wid his "series mod" 250 W rig on 160F. Bennie is in Hastings nw working at the "nut-house", es ts whr most BCLs wud say al us "hams" belong as they figger we're a trifle "off-frequency" all of us.

W9YLC has not concluded his experiments wid the vy-long 500 ft ant on 160 f as yet, but tinks it has helped sum in lessening local BCLs hearing him on their unselective rec'rs. OK Frank, but I still argue the "self-activity" shud be in the receiver insted of in the dealer!

W9FXN is another "antennae minded" Rasperry member but Mervin is trying for "altitude" of 70 ft high in middle since we all remember what phenomenal results W9YUM had wid his 90 ft tall inverted "V" es 10 W on 160F. I need a "sag-lifter" in middle of my ants, too. W9DR nw is using a Zepp since he bo't W9APJ's old rig es went to 400 W on 160F—W9AMY visited him 2 wks es helped him get it rebilt as did W9IRZ. W9IDR also has a T40 on 10 nw es then.

W9QWD is planning on giving us the "big hop" es shud b in the land of orange blossoms es sunshine by time this is read, wid a W6 call. Sold his "silly-scope" to W9FXN.

And, next let us write about sum of the early-risers I hv bn contacting on 75F b4 break-fast. W9NJO furnished me a bit of thrill as I originally owned t call as a "luggable." W1-FMP "Wilkie" a Conn. contact; W1CY "Larry," and "Pat" with his 25 w es W1LEL—lovely English ladies—in Mass. W8NUI "Gibby" went out and caught "Pat" for me wen he hrd me tell W8MIS "Guy" tt I was seeking W1's—

RADIO NEWS covers the field.
25c at all newsstands.

RADIO ENGINEERING
DEGREE IN 2 YEARS

Intensive, specialized course, including strong basis in mathematics and electrical engineering, advanced Radio Theory and Design, Modern Laboratory, Low tuition, Self-help opportunities. Also 2-year courses in Aeronautical, Chemical, Civil, Electrical and Mechanical Engineering. Participation in Civilian Pilot Training Program. Enter September 3, December, March, June. Catalog.

INDIANA TECHNICAL COLLEGE
780 E. Washington Blvd., Fort Wayne, Ind.

Correspondence Courses in
RADIO and ELECTRICAL ENGINEERING

ELECTRICAL ENGINEERING Get good electrical field. Prepare yourself at Low Cost, for secure future. Modern course, so simplified anyone can understand quickly.

RADIO ENGINEERING Extra fine course in radio, public address, photo-electric work. Trains you to be super-service man, real vacuum-tube technician. Experimental kits furnished. Diploma on completion.

LOWAS'25 Either course, only \$25. Deferred payment plan available. Write for free copies of school catalogs, student magazines, full details. SEND NOW!

LINCOLN ENGINEERING SCHOOL, Box 931-R 20, LINCOLN Neb.

RADIO TECHNOLOGY

RCA Institutes offer an intensive course of high standard embracing all phases of Radio and Television. Practical training with modern equipment at New York and Chicago schools. Also specialized courses and Home Study Courses under "No obligation" plan. Catalog Dept. RN-40.

RCA INSTITUTES, Inc.
A Radio Corporation of America Service
75 Varlok St., New York 1154 Merchandise Mart, Chicago

RADIO ENGINEERING,
broadcasting, aviation and police radio, servicing, marine radio telegraphy and telephony, Morse telegraphy and railway accounting taught thoroughly. 48 weeks' Engineering course equivalent to 3 years of college radio work. All expenses low. Catalog free. School established 1874.
Dodge's Institute, Oak St., Valparaiso, Ind.

RADIO COURSES
Start September

RADIO OPERATING—BROADCASTING
• **RADIO SERVICING**—a practical course
• **RADIO AMATEUR CODE** • **TELEVISION**
• **ELECTRONICS**—1 yr. day course, 2 yrs. eve. Day and Evening Classes. Booklet Upon Request.

New York Y.M.C.A. Schools
7 W. 63rd St. New York City

Last time previous QSO wid "Gibby" had been a N.Y. to Honolulu round-trip on hi-trip end of 75. If ani of u birds "miss" WSMIS, it will be 'cause I've talked Guy into becomin' a becumin'-cowboy. Hi.

Our walkin' beefsteaks intrigue Guy—of course, our large ranches wid "space enuf" to string up even a Beverage antennae mite be sumthin' to do wid it. A BCL friend of mine told Guy one morn, hi bro-bi-law managed a ranch wid 120,000 acres in it! It is one of our "largest" ranches. I cud hr W21R "Heinie" here OK wen rest of gang back thr didn't even know he wuz on—"skip" on various ants, is "odd" at times.

W2LCB Irv co-operated in helping me clikk wid sum desired W1s.

W3FN John down whr the Bluejackets grow told W6HAR to have his speedboat ready as he wud b out thr abt May 15th. "Hopps" sed he wud by said-boat es many other things read to entertain W3FN wen dawn arrove. "Stumpy" most of those east-coast birds will only give an R6-7 (wich I think is rating me a trifle high at that) es give W6's es 7's R7-9, but gosh! What a lotta stumick-akin goes on abt "tt W3" causin' QRM if I'm on blowing off! Hi. W3AIJ in Va. wuz another nice contact 4 me: "Bitt" is mail carrier thr. W8ZX and W8CHU also are among the gang worked often. Once two of those W3's were on at the same time and I could copy the one out here which those back there cudn't get thru others sed skip agn, I gess. Em wat bunch sez. K6QOE Harold is still operating 75P es given' em DX contacts, tho I hadn't happened to hear the cont from Kokahahi since last fall wen raised him miself.

W7AQX the 1 KW rig on 75 from Rodeo town Pendleton, Ore., was abt onli stu I cud hr thru QRN one morn but mi sig cudn't compete wid QRN es QRM so had give it up in abt 15 min ragchaw. An eastern "ham" once told me this W7 was loudest 75 "ham" they heard back thr averaging abt ACTUAL R6-7, es rest of W7's es 6's did well to get-in R2-5 es actual R6 was tops; T H O, "of course" they always gave the 6's es 7's R6-9 past reports. Hi. I agree with the "ham" in past Hamchatter who sed "S" or "R" meter readings were of no value either. To much variation in ants tt R tied onto recrs. The standard as for VERY-LOUD sig to be rated at R9! Em thr on "down." Anyway, after all: wats the diff, how loud the report? The main thing is dutz-the-other-guy cum back es answer ur questions correctly! That's the proof of how-wel he actually heard-ya.

And, how the BCLs stared at our "ham" friend like the other morn when he walked dwn the street like an R9-plus sig wearing two ties around his neck! Celebrating: DX; his best-gal just proposed to him; being a new-pop; his mother-bi-law's leaving for her home; getting outta the dawg-house; a successful 2 1/2 meter QSO across town; just what was cause for this undue elation signified by "two ties" at once—well, you write you own conclusion; for I myself am discontinuing this spasm rite hr es nw.

Unless otherwise mentioned, here's news of the W1's:

JDP is the Jr op at KYJ in Methuen. Gess the OM got jealous, hi hi. Charlie McCarthy is pretty popular around these parts. The ten meter band suddenly goes completely dead at 8 P.M. and at 8:30 the old band comes to life agn. The answer is, so many of the BCL's listen to the program that the hams don't wan to autotoneize them wid possible interference, so they just shut down. Now that's the real ham spirit, isn't it?

MKM the "Mighty Kilowatt Modulator," is on 10 and 160 wid abt a kw and a Mims 3 el rotary. Even wid the punk conditions on 10, caused by the 11 year cycle, he's been wking out swell and reved no rept lower than a 5-9 plus.

SIT is building a rig for a local boy and the Jr op is doing the same for himself in the kitchen. The Xyl will probably hve to move out sn.

The Farmer's Net on 160 has a good system of limiting the length of transmissions, so that the QSO will not lag too long at one station. Each station has a three min "hour" glass, when it start ur trans u turn the glass over. When all the sand has emptied into the bottom container, even if in the middle of a story or sentence, u hve to turn it along to the next ham.

IGD attending Boston University. (Our Alma Mater.)

Here's a little DX that has been coming in here in the 1st district: PY2IT, PY2AK, PY2ER, CO2GL, CO2RO, CO2JH, CO2BK, CO2VP, YV5ACE, YV5ACA, YV1AN, HK3CK, HK3CO, HC1JE, H17G, LU1DA, LU1QA, LU3HK, LU4KA, LU4XA, LU4FA, LU5BB, LU5HE, LU5AN, CE3EW, CE3EB, CE3AM, CE2CO, K6PCW, K7BUB, KA1CS, XU1A, XU1B, XU5AM, XU8MC, XU8RG, CX1DD, EK1AF, J5CW, ST2S. All these stations were on 20 fone. While ten has been inactive the only outside stuff being heard here are: NY4AB, HC1JB, and OQ5AB. All these stations were 5-9. All 20 meter stations averaged 3-8. BE the fellow wid the Mims wrkd KA1CS on 20 for the 97th time in a three way wid XU8MC. Previous to this QSO Charlie had wrkd XU8RG. The following day Charlie wrkd J5CW, (he was the first U.S. station the J wrkd in the Jap fone contest). Following this contact he got XU5AM and then XU1B. All this was going on while we were having a tuff time getting into the W1's. Gee, some of the hams hve all the luck! GDY was hving a hard time wrking and hear-

ing the Asians before the hurricane. But since the gale blew down a large tree near his antenna, Herb tells us that the Asians come in wid real loud sigs, and he has no trouble getting them. (No wonder we havn't been getting out so hot. We've got practically a whole forest in our back yard.) P. S. Sears Roebuck has on page 476 a double-edged axe at a real bargain. Better get your order in sn.

The yl at CB (CB's daughter) can throw a mean ball at bowling. She's only been down from the country a year and has already "made the newspapers." Her picture was in the Boston Post and Boston Herald of Jan. 30, concerning the Boston Community Fund. (No wonder the Fund reached its goal for the first time in three years.)

IQY on 20 having a fb time. 4GLQ "Four Good Looking Queens" is in any man's language "Ham's Paradise." Dusty's station is located in a glass enclosed room and his transmitter is protected from visitors by a glass partition. The rig itself is contained in a rack 6 1/2 ft. high, 30 inches wide and 33 in. deep wid brown Masonite panels. All the power supplies are specially built to Dusty's specification by Phelps Dodge Tran. Co. The final plate transformer weighs 350 lbs. and costs \$500.00, the chokes 90 lbs. apiece and the filter condensers 60 lbs. And believe it or not when the transmitter is on the air there is not the slightest trace of hum. The rig runs normally at 1KW and is capable of taking 5KW's input. (Reason for this is that Dusty believes in regulation and plenty of leeway so as not to injure any of the components in the rig.) At the present time he is having installed a special 15KVA transformer by the local power Co., to be used only for the radio shack, so people in the rest of the house will be able to read by electric lights instead of by candles while the rig is on. Hi, hi. The antenna is a specially constructed Johnson 20 meter "Q". 4GLQ says that he has never been bothered wid QRM since he has been on 20. (And that's something to brag abt.) Dusty hangs out on the low edge of the 20 fone band and u can usually find JOM under GLQ when he shuts his carrier. Miles Weeks, WV, got into ham radio thru a letter in QST by KH. KH and WV are better known among the ham fraternities as the "Radio Twins." That was 12 years ago and both Miles and George has gone a long way since. They have set up quite a record for the new boys to shoot at. AAR is on 2 1/2 meters operating portable mobile.

JTS says wid the temperature hovering arnd 14 below so much, the other day when it went up to 2 above he went thr his trunk for his bathing suit. (I'll bet its a two piece at that.)

Listen for OA4A on 28144 kc. Sunday mornings. He is a new station in Peru and it is rumored that he QSL's. Also look for CX1AA on 28700. IIA has a new HalliCrafter 5-10 after having trouble wid the HP-10. SI one of the last stations to desert the old five meter band here in the Boston area is now on ten. His outfit consists of HK-254's in the final wid a T-20 in the Buffer, and HP-200's in class B. Roy is a Super Pro. In the old days SI usta have his antenna located on top of a roof across the way from his QTH. One time the outfit up to the most output according to the glow. When Joe wud like to show the rig off to sum of his pals and the unique system of tuning the transmitter, he wud have his XYL 20 out on the front porch (even in the coldest days of winter) with a mirror. The XYL wud pick up the glow of the bulb and reflect it into the shack, while Joe proudly wud tune the rig. (Where'd u get sech an XYL ST?)

4FUU will try to carry on skeed wid KC4USA on ten meters starting Feb. 18, and every Sunday following. They have a preferred list of the 10 meter stations which have outstanding sigs es they will take special pains in contacting them. The KC4's have been on both 10 and 20 but are experiencing a lot of trouble. (The type of which is unknown.) NY4AD is a U.S. Naval station in Cuba. The station is therefore governed by FCC rulings and cannot get out in the U.S. 10 meter c. w. band wid fone as they wud like to. His call before he went into the Cuba Naval Base was W6LD. He is always 5-9 plus. The reason for this he explains is due to the wet land on which he is located. He holds the position of Warrant Officer.

HC1JB is located 10,000 ft. above sea level and puts in a tremendously strong sig. The station is licensed both as an amateur and as a commercial experimental station. The purpose of the station is to carry on preliminary tests on the 1KW ham and exp. outfit in order to secure some accurate info on High Freq sigs from that QTH.

The site of which is to be the location of HCJB a 5KW commercial station on 12 1/2 megs. The stations are equipped wid a Bassett Beam, fed wid Concentric cable. Being at the present time Ham and etc. lic. he will wrk cross-bands, from 12 1/2 to 10. He will call CQ 10 meters, and wud like repts from the Chicago and East coast area. Glad to report that JIS is home from the hospital and is recuperating. One of his constant visitors was SI, who kept Charlie informed abt the doings on 5 and 10. Keep up the good wrk Charlie, all the fellas are waiting to hear those sigs coming from the town of Rockland agn.

BES has a new RME. It took the help of CPI and SLWA to teach Lou how to run the thing. Lou was wondering why he wasn't hearing the stations vy well. He was using a steam pipe for an antenna. hi. Hams to the rescue—When Boston was hit

Why Should New Men Get the New Jobs?

INSURE YOUR FUTURE!



Start Training Now for a Better Job in RADIO & TELEVISION ENGINEERING

Do you ever sit down and "look your job in the face"? Radio plays no favorites... the GOOD men get the GOOD jobs. Right now is the time to equip yourself with the technical training that will qualify you for the many new opportunities in broadcasting, frequency modulation, facsimile and television. The fact that men in more than 300 broadcasting stations selected CREI training, is evidence that it pays dividends in better jobs and more money. CREI training in Practical Radio and Television Engineering is available in home-study and residence courses. Let us suggest the course best suited for you to keep pace with Radio.

Write for Free Booklet: "The CREI Tested Plan"



To enable us to send you complete information, please state briefly your radio experience, education and present position—and whether you are interested in home-study or residence training.

CAPITOL RADIO Engineering Institute
Dept. RN-8, 3224-16th St. N. W., WASH., D. C.

YOU CAN BECOME A MONEY-MAKING RADIO EXPERT

WITH THE **New SPRAYBERRY** Personalized HOME TRAINING in **RADIO and TELEVISION**

You Learn Easily in Your Spare Hours ... By Doing Many Experiments with Up-To-Date Equipment

Here's a really fine, up-to-the-minute Radio and Television Training that's specially designed to give you quick results. **TRAINING PREPARES YOU FOR GOOD RADIO JOBS... AT EXCELLENT PAY.** My training starts right at the beginning of Radio... unfolds each subject in a simplified, logical, understandable style. You easily learn Television, Electronics, Facsimile Radio, Radio Set Repair and Installation Work, etc.

NO PREVIOUS EXPERIENCE NEEDED! It makes no difference what your education has been, I can fit you for a good paying Radio job. Your success is my full responsibility.

YOU GET PROFESSIONAL TEST EQUIPMENT PLUS EXPERIMENTAL OUTFITS

Includes 146 Radio Parts (to build complete Receiver), Tools, All-Wave, All-Purpose Analyzer, and Experimental Outfits for conducting actual experiments with your own hands.

I Supply

- THE RADIO PARTS
- DIODI TOOLS
- ALL PURPOSE ANALYZER

EARN WHILE YOU LEARN

My **BUSINESS BUILDERS** show you how to put your equipment to practical use in handling actual money-making Radio Service Jobs shortly after you begin training.

SERVICEMEN

I offer Advanced Training for those already in Radio. Get complete details in my FREE 52-page Book. The **Sprayberry Course** is Sold Under a Money-back Agreement.

RUSH COUPON for BIG FREE BOOK

SPRAYBERRY ACADEMY OF RADIO
F. L. Sprayberry, Pres.,
325-H University Place, N.W.,
Washington, D. C.

Please send me FREE copy of "HOW TO MAKE MONEY IN RADIO."

Name..... Age.....
Address.....
City..... State.....
Tear off this coupon, mail in envelope or paste on penny postcard. Servicemen—Check here

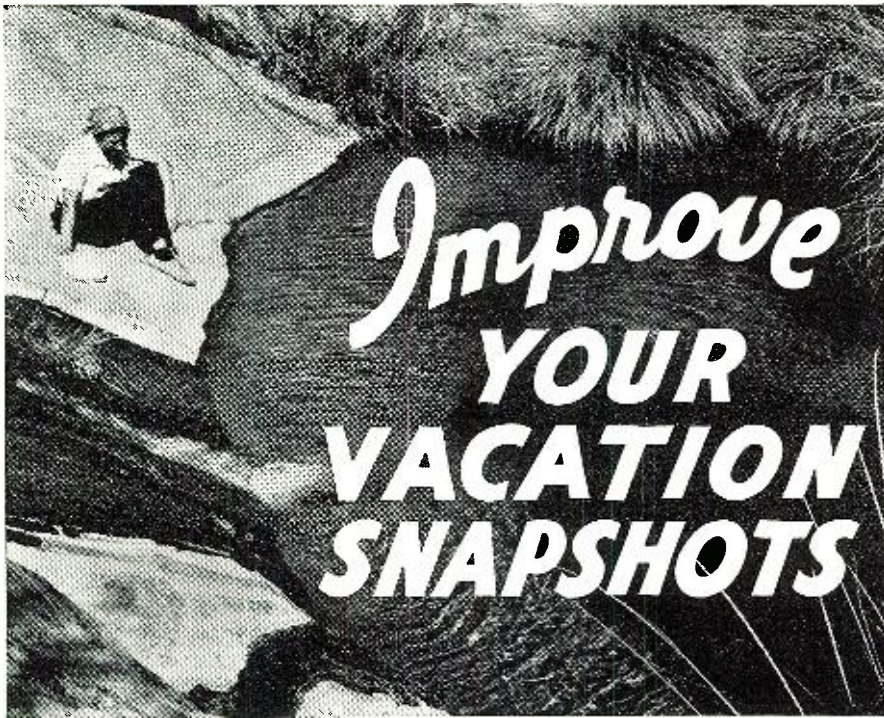

HAVE you planned what kind of pictures you are going to take on your vacation this year? Have you considered what you might do to make those pictures the best you ever took? Remember, a little thought and planning before you leave on your vacation, plus active consideration of certain rules, points the way to better pictures. Whether you are going on a week-end drive or a long tour . . . the suggestions offered on page 28 of the August POPULAR PHOTOGRAPHY will improve your vacation pictures and add pleasure to your trip!

★ **PHOTOGRAPHING THE RODEO**—Watching the bronco-busters is exciting. But when you take your camera with you and bring home the story in pictures it's an experience you won't forget. Let Frank Reeves, noted rodeo photographer of Fort Worth, Texas, show you exactly how to capture the thrills and spills of rodeo events . . . bucking horses, ill-tempered steers, nimble-footed calves, cowboys riding and roping. Turn to page 32.

★ **MAKE YOUR VACATION PAY**—If you want to travel during your vacation this summer—if you want to have a lot of fun and be paid well for having it—then don't fail to read *Travel Pictures Pay Your Way* by H. Donald Spatz. This industrious amateur photographer of Reading, Pennsylvania, tells how you, too, can take fascinating travel pictures—yes, pictures that sell! You'll find this timely article on page 34 of your August POPULAR PHOTOGRAPHY!

★ **POPULAR PHOTOGRAPHY** can help you get the most out of your camera this summer. The August Issue is bubbling over with vacation talk . . . helpful hints that will make your shutter finger twitch! Expert photographers tell you how to plan your camera vacation; avoid common mistakes; take dramatic urban shots; film the youngsters; capture garden, marine and desert pictures. Yes, camera fans, you're missing too much if you miss the big, colorful

AUGUST ISSUE

Popular Photography

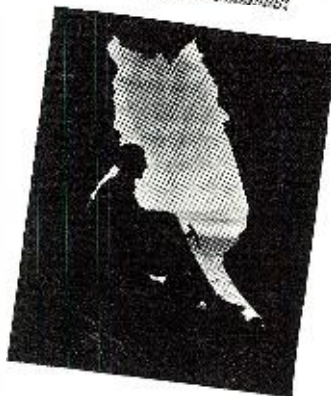
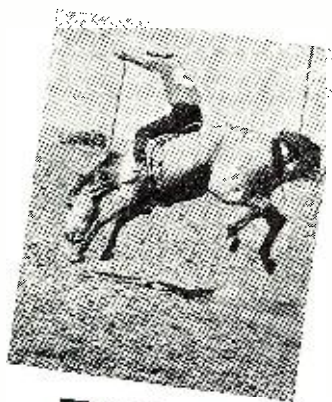

EXTRA! CAVALCADE OF COLOR!
4 PAGES OF BRILLIANT
COLOR PHOTOGRAPHS . . .

NOW ON SALE AT ALL NEWSSTANDS — 25¢

by a blizzard and a 60-mile an hour gale many people were stranded far from their homes due to the interruption of the transportation services. JGN was expecting his XYL home abt 8:30 p.m. When the clock rolled arnd to 10 p.m., Tommy got worried abt his wife's safety. Tom donned boots etc. and started to make his way to a corner drug store where he cud get a telephone. He didn't get very far becuz blocking the street were 7 and 8 ft. drifts which were unpassable. Not knowing what to do Tom thought of his ham outfit. Operating under difficulty becuz he had frozen his hand while trying to get by the drifts, Tom gave out a "CQ emergency." MIG, JOM, and GOU answered his call. MIG being lowest in freq on the band got Tom. MIG wid the help of his YL (who was stranded at Nick's house, and hving a swell time) called the various railway terminals and had Tom's XYL paged. Having no success wid this, they next called all the local police stations and gave them a full description of the person missing, and also got a couple of squad cars to try to break thru to Tom to give him medical aid for his frozen hand. But still even wid the help of LYH, MME, they were unable to locate his wife. At this point a broad interference blocked out all the stations that Tom was hearing. GOU QSYed to the high end of the band and after some trouble got in contact wid JGN. At 10:30 p.m. to confuse things more Tommy's rig went off the air, and all efforts to raise him failed. Meanwhile MIG had received a call from the cops saying that they were unable to get to Tom's QTH becuz the Boulevard leading to his street was blocked wid stalled cars. The whole ten meter local gang sat hopin' for the best, that Tom was OK and that he wud sn return on the air. At a quarter to one in the a.m., Tom came on the air agn and a very happy and grateful voice announced that "the little woman" had weathered the storm and had walked quite a distance and had broken thru the drifts, which Tom and the cops cudn't do. After thanking the gang for the swell rig they had done Tom and the rest of the fellas pulled switches for some much needed rest. Some of the other stations who helped or were asked to stand by until needed were: JLQ, GDY, LYH, LMG, AJA, and BDM.

The next morning I wrked 5CVW who suggested that Tommy build up a pack transmitter for his XYL and have her check into him every 10 or 15 minutes. (I think it wud be a pretty good idea Tom. I'm sure the local gang wud contribute the parts.)

Have any of u fellas noticed the increase of the local c. w. sigs on ten and the decrease in the lone sigs? The reason for this is that JOM can't copy c. w. so hot ("get it"), or maybe their keying. Most of them are keying the oscillator and it usually takes abt 10 minutes to get the other fellas call thru becuz it takes abt seven or eight seconds before xtal kicks into oscillation after the key is closed.

The second op down here wants me to ask the Ed if he knows what Confucius said abt Ham Radio. [No! So I ain't educated! Ed.]

When LMB "the Loud Mouthed Baboon," (as LEU puts it) hears some rare DX such as a "J", us better steer clear of his QTH. Here's the reason. Al's rig and revr are set up in the dining room (that's so as he won't miss any of the DX while eating) and his so-called rotary can only be turned from the back yard. When Al hears the DX station he jumps from his chair races across the room snaps on the flaments on the transmitter dashes out thru the kitchen, out the rear hall, then slides down the banister to the first floor, thru the rear door. (he don't bother opening it) then wades thru the mud in the yard over to his pole. He then untangles the ropes that turn the thing arnd and races back to the radio tracking mud thru the whole house. He usually returns from his trip in time to hear one of his local friends (?) get the Jap, and then hold him for abt half an hour. By that time the J has to QRT becuz his XYL is calling him for breakfast, while Al finishes nibbling his nails and curses the day when he first heard of ham radio. Al must be getting the system down pretty "pat" becuz he wrked K7GZH in the Aleutian Islands the other day and got an R-7.

K7GZH operates on 28504 and says that he QSL's. GOU wrked 6NWK off the Hawaiian Islands. 6NWK is a portable marine station. He told Ernie (GOU) that he had heard his sigs while off the China coast, which Ernie says should convince anyone of the capabilities of the vertical Y match antenna. Ernie asked us especially to get this bit of news in before the deadline of this edition, and he promises a treatise on the Y match for us and we will have it in the next issue.

AIZ portable marine just got into the port of Boston today and he was informed that he cud not operate on the ham bands until the existing war conditions wud clear away. We don't know if this applies to all marine amateur stations as put forth by the FCC, or if AIZ's company put him on the Q.T.

KZD is waiting for his final amplifier to go so he can build up a higher pwr job. Pat has gone in for recordings.

JQA the old pioneer station on 5, is on 2½ wid a pr of HK24's.

EJU who has bn without his call for many yrs just got it back es is on 2½. Get JHR to tell u what his rig consists of for ten meters. It takes him a whole xmission just to get it off his chest. He's got abt as many pwr supplies as a small bc station, and it's all rigged up fr push-to talk etc. etc.

KH has bot a kit from Browning to recve the freq mod station up in Paxton. He says it really is the berries. At the Boston Hamfest

there was a demo of one of the revrs and many of the boys that it was a real orch.

LXR who has a Harvey 100T transmitter and a Nat. NC-100 and also an HRO has built himself a small rig to use for local work. Bill got a bug for Xmas from his xyl and was trying it out on his rig to get some practice. He called CQ a few times and signed his call, then noticed that the rig had the antenna on, so Bill gave the dials on the revr a twist and to his surprise found some station out west calling him.

There are 65 requests in to the FCC for freq mod stations according to WISS.

KTV and KEK in N.H. are coming thru hr in Boston wid surprisingly gd sigs. JSN came back on ten after a short absence. After playing around wid all types of antennas he finally decided on a 3 el rot.

WV is going to rebuild one of his 3 xmtrs and will use RK20's in parallel on 40 and 80 c. w.

JGN has just abt finished his new superhet. All that it lacks is a noise silencer and Tommy is waiting to get some info on Dana Bacon's new brainchild before he puts it in. Frm Tom's description it must be a honey.

MCX is leaving the Hub to go down south to the Naval Training School.

HKK, top man in the DX contest (phone) last yr is over at Harvard. Dana is an expert on Yaesu, V beams and etc. Dana doesn't go in for any of these measly 2 or 3 el. hi hi.

5DEW was really overjoyed at the prospect of going to a Leap Year party at a local college (local to 5DEW). The little "dew drp" thinks maybe her chance has come. (All the fore-going is, of course, according to a statement made by 5DEW.)

CWH on 75 fone with a real healthy sock. CPI is looking thru the catalogs for an amplifier to kick his 250THs in the modulator.

ARN is all set to build up a beam. Put the question is, will it be a 10 or 20 meter beam. With the punk conditions on ten it w'l probably be a 20 meter job.

MKS has built a vy fb little rig for 10 which consists of a 616 stal ose on 20, doubling to 10 and an HK-24 in the fml on ten. Wid a little help frm LYH the outfit will sn be wking fine. Guy (LYH) borrowed MKS's stal mike and tried it on his own rig. Now Guy is on the market for one. hi hi.

JLZ is on 20 fone and giving a swell tme. When QRM gets too tough you'll find him on 2 1/2. His outfit consists of an 808 in the fml wid abt 100 wts inpt, mod wid 616 and a home-built dynamic mike (which sounds as good as some of those on the market).

MLG is a newcomer on 10 c. w. Will sn be on fone when he can collect enough of what it takes! His first QSO ws HWV.

On Jan. 10, the local boys on ten meters were quite active and we noticed that every one was speaking abt a strange flutter on all stations. All the boys made their contacts short, and took frequent checks on the bnd to see if the short skip (?) they expected, had come in yet. (Like me looking for my ship.) Some of the boys thought it was a radical change in condx es expected an extremely long skip es improved condx. Well, I guess u know by this time that the 10 meter bnd did not open up es there was no long skip the following few days. Here's the answer and we didn't go to Information Please for it. The flutter was agn caused by airplanes flying overhead, which we mentioned last mo. We shud have bn on the air es explained the situation to the boys, but we didn't hve the heart to explode their castles in the air and hi hopes. (After all, the band has been pretty dead of late.) P.S. Some of the boys were looking in their files to see when the s.s. came in last yr es others looked to see when the nw moon was due. (Usually abt the same time as the rent.) As we're writing this, a plane is flying over head es a sta is fluttering. As he turns it over to Spud, he is asking him to look over the bnd beuz he don't want to miss anything. Ho Hum. I was going to say something but I'll just slip out quietly es maybe turn it over to Ed.

Believe it or not fellows, we're beginning to get fan mail (not after they read the above) es info from the local gang. One fellow would like to know what co. is going to manufacture the safety device shown in the cartoon, on page 37 of the Jan. R. N. Maybe Ziff Davis, Huh?

More on the Continental Clipper. WV recently handled a msge from LSV to a bank president in Boston. Miles lrd that the bnk pres. LSV es himself all were grads of Harvard, but a few yrs apart. When he finished his fone conversation Miles came back to the rig es called the Clipper, but he had faded out. The pres. now gets fone calls from flocks of hams, but as yet LSV does not know whether any of his ms-gs from all over the country have reached his old school chum.

LEU who has just turned in the old Pro fr the 40 meter wants to know why they ever put "screwy tuning meter" on the old model. From all rpts the new job really goes to twn es has a gd meter, fine stal filter and a noise silencer that works (es that is sumpin').

The condx r so punk on 10 that many of the old stal boys have gone up on 20 or down to 2 1/2 where the contacts r a little more certain of coming out 100%.

KJD is in th mkt for a superhet. He is at present bldg a 275 watt modulator es will probably go up on 20 fone.

MBF has a Howard and can't hear anything on ten except his own sigs which come in vy weak. I hve a suggestion but I'll tell u over the air.

WV wrkd BDM abt a wk ago, the 1st time they hve contacted since they worked each other 12 yrs ago, when they had both just revd their tickets. Miles keeps a very fine filing system es remarked to Joe that he had a notation that his fist on the original contact was vy punk. Joe came back es said that his file told him Miles' fist was worse. Well, we can't vouch for the authenticity of Joe's file, but we do know that he was vy mch surprised to hear Miles come back to him, call him by his name es bring back fond memories by calling off the rig Joe used 12 back. How many of us can remember the rig we used a few years back? Miles, incidentally has wrkd over 1,000 different "QY" stations.

We hrd SI speaking to his XYL abt knitting some covers to pull over the elements of his beam. For the winter. Anyone else care to send in an order for a set, they will probably go pretty fast. You can order for 2-3-4 element beams.

LPX, who was until he recently moved away, the 4th operator and chief construction man at JOM, called me up and was vy much peeved at the small amt of space we allotted to him last mo. Wt until next mo SI. The Ed. will probably kick us all out this mo.

You'd be surprised at what goes on over the 2 1/2 meter bnd. They even let u take pics down there. In our location there must be abt 50 or 60 stations in a radius of 4 or 5 miles. Even with all the snare down there, someone, not me, got the brite idea of drawing lots and getting up a mutual agreement pact to decide what nites who would be on what frequency.

BY BETH W8NCJ ROSENBERG: W8NCJ has now finally received QSL from EL2M, thanks to W2LOP and the information appearing in March Hamchatter. Now has cards from 46 countries worked. Hopes someday to make the C.C.

W8CUN, W8GEJ, W8NCJ and XYL attended hamfest sponsored by the Pittsburgh Area Radio Council and held at the Fort Pitt Hotel on February 24th. Over 400 hams were present and the principle speakers included Dr. E. C. Woodruff (president of ARRL), Lieut. W. L. Montgomery of the Radio Intelligence Corps, and Fred Smith of TWA.

W8POX has rebuilt his rig and now using T20 in final running about 60 watts input on 80 meter c. w.

Beth, XYL operator at W8NCJ works high end of 40 meter c. w. band during daytime and is on lookout for stations having W. Penna. traffic. Has good connections on 80 meter ORS net in evening so give W8NCJ a call if you have tic to move.

W8QZV states: The DX hounds W8AA, W8TNN and myself are QRT to the higher frequencies because very little DX is heard around these parts. For

YOU can LEARN CODE the CANDLER WAY

SHORT CUT THOSE TEDIOUS HOURS OF UNDIRECTED PRACTICE

Like thousands upon thousands of others, after a few weeks of Candler Training, you'll find you've made more progress than you did with months of undirected practice. With Candler Training, you start with the correct fundamentals. You learn Sound Consciousness, and before you know it, you'll be able to read words, even sentences, as easily as you read print—without strain or conscious effort. And you'll be able to send with that easily read, rhythmic speed you hear when a Candler Trained operator gets on the air. Ask any skilled operator about Candler Training. Send for FREE "Book of Facts" today, and read what Candler Training did for former Candler students. You'll enjoy reading the Book of Facts, with all its interesting code tips. Send for it today!

CANDLER SYSTEM CO.
Dept. N-8 Asheville, North Carolina, U. S. A.

Send for FREE 1940 Book of Facts



Midget Radio

WEIGHTS ONLY 6 OZS. SMALL AS A CIGARETTE PACKAGE. RECEIVES STATIONS WITH CLEAR TONE. PATENTED FIXED RECTIFIER! NO UPKEEP—only one moving part. TUBELESS! BATTERYLESS! NEW PATENTED DESIGN. Enclosed geared luminous color dial for easy tuning. MANY OWNERS PLEASUED WITH RECEPTION & DISTANCE OBTAINED WITH THIS NOVEL RADIO. ONE YEAR GUARANTEE!

Send ready to listen with instructions and tiny phone for use in homes, offices, hotels, in bed, etc. SIMPLE TO CONNECT—NO ELECTRICITY NEEDED! SEND NO MONEY! Pay postman only \$2.99 plus postage & charges or send \$2.99 check, M.O., Cash and you will be sent postpaid. A most unusual value. ORDER NOW! MIDGET RADIO CO. Dept. HG-8 Kearney, Nebr.



FREE! VERY LATEST PROFIT GUIDE

Everything in RADIO!

Complete Selections Guaranteed Quality Replacement Parts

Everything you need in the way of exact duplicate or universal replacement or repair parts. Tubes, condensers, resistors, transformers, hardware, tools, etc. Leading brands. Every item guaranteed. Prices are low. Clean fresh stock.

Latest Radio Sets
A model for every purse and purpose. Midgets, Battery Portables, Table Models, Consoles, and Phono-Radio combinations—for operation on AC, DC, or battery power.

Public Address Equipment
A complete line of amplifiers, microphones, speaker baffles and accessories for every type of installation—permanent, portable and mobile. Amplifiers from 5 to 100 watts.

Auto Radios & Accessories
Complete auto radio section—lists the latest and finest auto radios, aerials, vibrators, custom panel controls, suppressors, padding condensers, pilot and dash lights, etc.

New Electrical Appliances
Extra profits for you! Standard Brand Electric Irons, Grills, Toasters, Perculators, Waffle Irons, Vacuum Cleaners, Clocks, Mixers, etc., at lowest prices.

SAVE MONEY AT RADOLEK



MAIL THIS COUPON TODAY

The RADOLEK CO.
601 W. Randolph St., Chicago, Dept. R-44
Send the latest Radio Profit Guide FREE.

Name.....
Address.....Dealer?.....
Experimenter?.....Serviceman?.....Amateur?.....

CAMERA FANS!
HERE'S A WELL-ROUNDED PHOTOGRAPHIC EDUCATION

Let the PHOTOGRAPHIC SERIES of the Little Technical Library guide you through every phase of photography... teach you the masterful technique of America's leading photographers. If you have yet to become acquainted with this instructive photographic library, go to your camera store or book dealer. Browse through the twenty authoritative pocket-size text books. Note how each complete volume covers its chosen subject with unprecedented thoroughness and accuracy... how each chapter is easy-to-read and easy-to-understand. Examine the scores of brilliant illustrations, the beautiful printing, and the rich binding. Camera fans—you'll need no words to convince you that here is the photographic library you have been dreaming of... a well-rounded photographic education.

Little Technical Library

PHOTOGRAPHIC SERIES
At all leading book, department and camera stores—or write for FREE list of titles! Address: LITTLE TECHNICAL LIBRARY, 608 S. Dearborn St., Chicago, Ill.

20 POCKET-SIZE TEXT BOOKS

50¢ EACH



TRICKS YOU CAN TEACH YOUR DOG

It's not necessary to possess a special gift or charm to teach your dog those parlor tricks that so delight the visiting company. Step by step, John Marsh, one of America's leading dog trainers, tells exactly how to teach your dog to jump, shut the door, shake hands, sit up, retrieve, and say his prayers . . . tricks that are the easiest for your dog to learn and the easiest for you to teach. If you would like to have your dog do tricks—and show your friends what a smart little Fido you own—then don't miss this authoritative, illustrated article.



I TRAIN VICIOUS DOGS

"They don't come too tough for me" . . . a boast that brought Michael Motzck a reputation as an expert trainer of vicious dogs. Hazard, a 90-pound ill-tempered German Shepard; a pit bull terrier, the canine Joe Louis of the midwest; Jiggs, a terrifying Great Dane; a "hypnotized" Doberman Pinscher . . . these are just a few of the scores of vicious dogs von Motzck has taught to be peace-loving canine citizens. This noted dog trainer demonstrates the amazingly complete control which may be obtained over a dog's mind through proper training methods.



CHINCHILLAS—\$3,200.00 A PAIR!

How would you like to own a pet whose progeny can easily make you very wealthy? One that doesn't slip out at night to howl on the back fence? One that doesn't shed hair all over the living room, bury bones in the lawn nor chase birds? And costs only three cents a week to feed! But here's the catch: the original cost of this "perfect pet" is just about twice its weight in gold! Read the thrilling story of how eleven priceless chinchillas made the hazardous trip from Chile to become the start of the world's largest chinchilla farm!

There are twenty other great features and articles in the August PETS you will also want to read . . . good, sound, and intensely interesting information about pets of all kinds . . . all brilliantly illustrated and ably written by the foremost authorities in the pet world. Make PETS, the only magazine of its kind on earth, a "must" twelve months of the year. Start with the

BIG AUGUST ISSUE

NOW ON SALE At All Newsstands

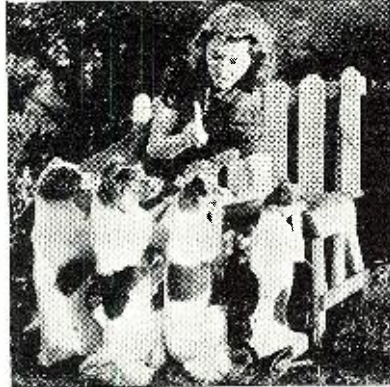

MONKEY BUSINESS

So you think you have troubles, eh? Well, how would you like to play host to over 600 monkeys seven days a week from early morning to near midnight? Had you all these monkeys you'd probably say, "What can I do with all these animals? Gosh, guess I'll have to go in business!" And that's exactly what a group of men have done in Hollywood! Don't fail to read all about "Monkey Island" . . . the home of one of the largest collections of Rhesus monkeys in the world! You'll find this entertaining article by Frank Cunningham in the August PETS!



PETS

Formerly POPULAR PETS

the last two months 20 has been going dead early in the evening and it doesn't wake up until most of the fellows have gone to work but all are waiting till the DX flies in the spring.

W8ECZ who was QRT for 8 years is back on 160 and for Xmas his wife presented him with a Jr. op. Law of averages finally came Larry's way because he has five girls and finally a boy came around.

W8LAK has been busy building a boat, but has it done. His signal will be heard on 40 very soon and next spring we will be taking up boating as well as DX hunting.

Several new hams on and really putting Bay City on the map. Among them are W8TJO, W8SMK, W8TVK.

JOE, WIKMY, is resigning as Emergency Coordinator for Lowell and vicinity—leaving position open for a good active ham in that vicinity. He must be affiliated with ARRL. Must be level headed and live wire. No shirk wanted, as E.C. he must have his town all lined up when the emergency arises.

Ed, W1JED, has his eyes glued to Radio Mag. on this new system of cathode modulation. He is due to break out again soon.

Talking of QSL's, your old gossip has a record (he thinks). He has 9 qsl's from SWL's who have actually copied him on CW, now he wants to know if any of the gang can beat that record. Qsl's from Swl's on any CW bans! It proves we must be careful on our code language also.

Archie, W1JNU, officially appointed ARRL code practice station on 160 meters. His frequency is 1978 Kc. Time—6.00 to 7.00 P.M. Nights—Monday, Tuesday, Thursday and Friday.

Dick, W1FCU is back in Florida. He has terminated his engineer connection with W1AW, and is now working with some airway company in Fla. Kilburn E. Culley, W1KCB, now operating as engineer in W1FCU's place at W1AW. Paul, W1HXE now has a picture recording of Herb W1KBP's camp and radio shack. Paul sez in time he will have a recording of all the MVARC.

W7CBL the RR Morse Op at Casper has bn using a gud 160 F to QSO W9MEJ is "brother railroaders" hr in our state at Gordon whr "Jack" nw has a gud 160F gg himself wid 140 W inp.

W7GGG—gudness gracious Gertie—hrd hving nice family-type of gossip fm the Capital City to W9LLP—lousy lil phone—Terry in Ft. Collins, Colo. Both on 75F. W9LLE still keeps noon sked wid W7BCL Cheyenne who ops 160F then.

Had FB ragchew wid "Jeff" around 3 A.M. one morn after we had both called K7HGM Anchorage, Alaska, when K7GHM was lost by W7GBU for sum reason unexplainable as K7GHM wuz vy FB at the time they lost each other. K7GHM was using 730W inp to an 861 he sed es wuz telling the W7 Alaska was 25ths as big as our part of the U.S. es other pertinent fact abt Alaska—but none of us raised him after he es the W7 broke off. So "Jeff" W7EFL at Holter Dam, Mont—a prv-dam bit in 1916—es I renewed acquaintance, on 75F. Other 75F Montanans hrd often es wrkd then es nw are W7DXQ, W7CT es W7CPY.

Dawg-gone! Who'd hv believed it? W5HNR was hrd complaining tt the "SWL's" had deserted him es he wuz gettin' no crds! Say, did ani of U ever get less'n R9 report on a SWL crd? I nvr due, even wen usin' mi 2 W batt rig. Trub is, I nvr get 'em wen I want 'em es tt is wen rig is not perkin' decent es ani "honest" report whatever wud b welcome noose!

W5EGJ Perryton, Texas, on 75F has quite a set up. His distinguishing "pur" on his sig cums fm his 2KW AC plant on his 960 acre wheat farm. Plant turns 1800 RPM es eats a gallon of fuel an hour, to feed the T55s mod by 203Zs. "Herb" had nice sig hr wen he was QSO W9YCL es YCL had to use a pencil on his buffer to stop a "parasitic" condition each time he snapped rig on. Hi.

Boy, did tt W5BAT—boils abscesses tumors—cum "bating in" on 75F with his "ancient" 852's mod Class "A" by "antique" 212B running 600 W wid an HRO to get "replies" thru. W5BAT has Okla. City, Okla., as a QRA.

W5HFW Ponca City dropped in a nice 75F sig also, in afternoon.

Imagine W9GHY went visiting W9FFW in the Colo. Rockies as Milo was hrd fm thr on 75M. GHY is an old "Dxer" wid low-pwr but gud ants on 20 es 10, but often hrd on 75 at noontime. Good News! Sounds like "Hans" the well known W9KNZ may get released from the Hospital where he has bn confined past year or so. Wrks 75F fm bed thr, also continues 5M experiments.

W9OAR was heard putting in "his oar" in FB shape on 160 F.

W9RTQ over the western-slope at Grand Junction, Colo., gave me sum info on his FB-wrking rig 350 W into 203A's in a push-push linear amp crct is wat Cecil uses on "ham" bands. es he copies Trans-Radio px for BC stn thr for "eats." W9RX same qra es 75F band ops BC stn for his "dough."

During one of the regular Sunday morning round-tables on 75 W9FLM, W9MGV, W9UHT, W9KQX, W9IVT and myself were talking abt "DX." Kc4USC was mentioned es W9UHT our CW-expert sed W9POB had wrkd this South Pole "ham" on 20CW so W9KQX countered by contending "CW" shudn't count. Hi. As usual wen it came turn to W9IVT, Warren nonchalantly told the gang to try and get a squint at Kc4USC's log book and on contact No. 16 they wud find W9IVT, 14 contacts being on CW then Kc4USC changed to voice es Warren

was second QSO via gab. Hi. Hi. Mostly it seems, by time "others" merely "suspicion" sum DK-stn is "on" of IVT already has his QSL! A lotta time listening and a rotary abt 70 feet high is "how he duz it."

This "rumored" a certain femme "ham" marked a "colossally big" "X" (es, we doubt she meant X of the atmospheric variety either) opposite the name of her favorite politician and then proceeded to sign her name, AGE, QRA on the ballot!

Now for sum scandal ament the doin's of our own "White Spot" fraternity. W9AGB Ken of Seward is heard fairly frequently in late afternoons on 1.8 mc voice.

W9AGS—A sud sig—Omaha is "heard" hr on 75 F tho on 20P I can hear others call him, es once wid "short skip" heard him on 20 CW

W9BVD—the "un-awares" stn—at Marquette wid on Harry 160F.

W9DHO experimenting as usual. VF xtal holders R Harlan's "lastest" brainstrom. Keeps a Wed newn sked wid AMY wen he isn't out amongst the jump es JIVERS tootin' his hawn 4 'em.

W9EAT, Ceresco, wid his lil 5 watter finds mani of the OMs wid their ears washt out es able to hear him on 160F. Nice sig.

W9EGM—was heard nicely wid his xmtr on 160CW. More occupancy on 160 past season than for mani mani yrs; tho still most of CW on it band is dun in fone allocation! Why not use the whole darned band 4 wat U like, like we did prior to 1932???

W9FZY Norfolk is new one using his jaw on 1.8 mc thru a 2A5 "pushed" hard at 9 W inp. Cliff has a Sky Buddy 4 other 1/2 of stn.

W9GHM Winside uses two vibrapks wid view towards btr voltage regulation es economy as 2 lightly loaded vibrapaks pulls less "A" current it seems. Clarence use 6C5 Pierce es 6L6 as mod wid 8 W inp on 160F.

W9GZM is plumb new on 160F there at Lincoln. Hope "Doc" likes band.

W9JDO the YL-syesman tuk his 2 watter along wen he went to see his grandpop in Loveland, Colo. Wudya always like to "live in Loveland" Don? Hi. The Resberry Gang have the date in June es the YL "Ham" pickt out 4 Don who sez "Barkus is willin'" but gess said

YL ain't asked him yet this "Leap Yr." So lukes like we R gonna hafta wait til June is past 2 C if she becoms Mrs. W9IDO insted of W9—as she nw is. Radio romance to a "happy ending"? We awl how sew!

W9LHV nw of Ft. Omaha was another of mi 100 meter victims but Irvin did "gess" his way thru my sending. Ok. Hi. No wonder tho wen we find he is ex-W7CPZ, K7DNZ, K6PPB (more ex-calls than sum OW's hv had divorces es OMs) so in all t' spierience he mite-hv run onto sumone who sent worse than me!

W9IKZ once used a pair of tape-wrapped nails to key a fone xmtr whr he was visitng es need for CW arose—emergency stuff! Quite lo-pwrd rig so fairly safe wid insulation he had.

W9ISJ wil b on fm Cozad—which town ought to be very unhappy wid about a duzen "hams" in it lil burg—whr he is temporarily op'ng Morse. Had a T40 mod by 212D, bt this sees U!

W9IXZ is a new "ham" operating from Madison.

W9JHR 4mc gab Omaha. 375 W T55s on 75F; 6L6G 25W inp on 80 CW.

W9KQX Potter the old lumberman is the place to go visitin' if ya R of the preacher-variety es like ur fried-chicken. Dean is raisin' 500 of the lil yeepers agn this yr. Nope I won't b thr Dean as I don't crave those feathered fowls.

W9MJY was off air a while. Hving sent in his 802 4 checking as it got to drifting in his FB "Beautiful" (in looks and performance) ECO exciter unit which he has been using on all bands fm 10-160 M last yr. Tuk him several months of "spare time" to bld but wen I saw it last fall: it was a marvel.

IF PZ6ZK isn't a bootlegger he is entitled to the award for really putting Surinam on the air. (Quick, Henry, the Atlas) Pounding through in the DX contest with a note that varied between T9 and CX2AJ5, PZ6ZK gave plenty of fellows a new country.

Another eye opener was VU2XX on 14380. T6. He said to QSL via W1KHE—we hope Stuart knows about it. In the morning LX1SS has been panicing the band. He is genuine and does QSL, so there's a good reason for going after him. So many LX's have turned out to be phoney's that LX1SS almost got treated like the Shepherd in Aesop's famous tale of the Sbece, herd who almost hollered wolfe once too often.

Some of the DX being heard on the bands: K4KD; K4DTH; K4FCV; K4FKC; K5AA; K5AV; K5AZ; K6PAH; K6QYI; K6BRWZ; K7BAQ; K7GOM; EA7AV; EA5A; U5AH; PYLLD; EK1AF; KA1LB; HA5T; PZ6ZK; LX1SS; J9CA; XU6W; XU6K; CT10E; OQ5AM; KA1PO; PYSAD; J2MH; J3FZ; J3DF; J3FJ; CP1CD; J2KN; KA1JK; KA1HR; HH2MC; LU6DK; LU2CW; PJ3CO; P77B; PJ5BE; PJ6XX; CX2AJ; CX1CX; CX1BC; CE3AJ; CR6AJ; CR7AF; J8PG.

The new QTH of W9ORH is 9034 Commercial. He was a visitor at the last meeting. W9RBO has promised that the club would have a new eraser for its blackboard before the next meeting rolls around.

W7HOU ex W9RKH seems to have a mania for collecting calls. Every time he goes west he comes back with a new W7 call and we understand that if the YL's would leave him alone that he would get a rig on the air.

W9DVY has been transferred to Rockford, and expects to again be transferred, this time to Milwaukee. He is with the CAA. Bet we will see him at the QSO party next May.

W9ENX is rather chesky after working W3GNU and W4DVP with his 50 watts on 160. W9JOO is said to be in the market for a dog team. Seems to us that he takes those winter field days too darn serious.

W9IMB is now modulating on 20 meters. Davey Day, W9TIC, now spends his extra shekles collecting rare coins.

Bill Ward, W9TLB, Membership Chairman, sat beside W9OVJ at the November 3rd meeting, and now W9OVJ is a member of the Hamfesters Radio Club. Seems that Bill just never fails.

Ralph Dickson, W9GJO, is recovering from his recent auto smash-up. Ralph sez it takes more than five fractures to kill a good ham.

CMSW in 14.405 kc. has been trying to get 4C. He needs Asia and has been trying for J2OV every afternoon. His best DX is HA2N. Sergio was in the states in 1935 and expects to make another trip to see some of his W friends soon.

XUA is undoubtedly the best dx from Asia now. He is far inland and gives his location as being 200 miles from Tibet. He will be found in the evenings around 6:30 p.m. 14.396 kc.

LU2FC, the most consistent LU now says all cards to him should be sent via LU2FR. He passes the dope that his frequencies in the contest will be 7150 kc., 14.300 kc. and 28.600 kc.

Apparently the only Spanish stations on the air are EA7AV, EA5A (14.4187 kc.), and EEQ1 (7000 kc.). EA7AV works both phone and c. w. (14.408 kc. and 14.198 kc.) The Qth of EA7AV is Vecdor 15 Cadiz, Spain.

XE1CM passes the dope tt he wkld 7 mc., 14 mc., and 28 mc. during the contest. He tells us that XE2N is Champion of the dx contests down there and that he is gg to have a tough time having a better score than the history of XE2N.

There hasn't been much said about KC4USC but the real dope is tt he is on 14.386 kc. (T7). He is on regular every Sunday and Monday from 7:00 p.m. until 10:00 p.m. C.S.T. He is trying to get W48 and lacks a few of the harder states. He lays a good R7-8 signal in these parts.

(Please turn the page)

Learn at Home to MAKE MORE MONE



J. E. SMITH, Pres. Nat'l Radio Institute Established 25 years

I'll train you Quickly for Good Spare Time and Full Time Jobs in RADIO

Radio is a young growing field with a future, offering many good pay spare time and full time job opportunities. And you don't have to give up your present job to become a Radio Technician. I train you right at home in your spare time.

64 PAGE BOOK FREE MAIL COUPON



Works for State of Illinois



"If I had not taken your course I might still be doing odd jobs or digging ditches. I am working for the State of Illinois operating the 1,000 watt transmitter." R. S. LEWIS 1901 S. Basford, Springfield, Ill.



JOHN WASHKO 97 New Cranberry, Hazelton, Penna.

Why Many Radio Technicians Make \$30, \$40, \$50 a Week

Radio broadcasting stations employ Radio Technicians as operators, installation and maintenance men. Radio manufacturers employ testers, inspectors, foremen, servicemen in food-pay jobs. Radio jobbers and dealers employ installation and service men. Many Radio Technicians open their own Radio sales and repair businesses and make \$30, \$40, \$50 a week. Others hold their regular jobs and make \$5 to \$10 a week fixing Radios in spare time. Automobile, police, aviation, Commercial Radio, loud-speaker systems, electronic devices are other fields offering opportunities for which N. R. I. gives the required knowledge of Radio. Television promises to open good jobs soon.

Many Make \$5 to \$10 a Week Extra in Spare Time While Learning

The day you enroll, I start sending you Extra Money Job Sheets which start showing you how to do Radio repair jobs. Throughout your training I send plans and directions which have helped many make \$5, \$10 a week in spare time while learning. I send special Radio equipment to conduct experiments and build circuits. This 30-50 training method makes learning at home interesting, fascinating, practical. I ALSO GIVE YOU A MODERN, PROFESSIONAL ALL-WAVE, ALL-PURPOSE SET SERVICING INSTRUMENT to help you make money fixing Radios while learning and equip you for full time work after you graduate.

Find Out What Radio and Television Offer You

Act Today! Mail the coupon for my 64-page Book, "Rich Rewards in Radio." It points out Radio's spare time and full time opportunities and those coming in Television; tells about my course in Radio and Television; shows more than 100 letters from men I have trained, telling what they are doing and earning. Read my money back agreement. MAIL COUPON in an envelope, or paste on a penny postcard—NOW!

J. E. SMITH, President Dept. OHR, National Radio Institute Washington, D. C.

Mail this Now FREE Get 64-page Book

RICH REWARDS IN RADIO

J. E. SMITH, President Dept. OHR, National Radio Institute, Washington, D. C.

Dear Mr. Smith: Mail me FREE, without obligation your 64-page Book "Rich Rewards in Radio." (No salesman will call. Write plainly.)

AGE.....

NAME.....

ADDRESS.....

CITY..... STATE.....

Classified

Rate 15c per word. Minimum, 10 words.

CORRESPONDENCE COURSES

USED Correspondence Courses and Educational Books sold or rented. Inexpensive. Money-back guarantee. Write for Free Catalog listing 4000 bargains. (Courses Bought.) Lee Mountain, Pisgah, Alabama.

CORRESPONDENCE courses and educational books, slightly used. Sold. Rented. Exchanged. All subjects. Satisfaction guaranteed. Cash paid for used courses. Complete details and bargain catalog free. Send name. Nelson Company, H-237 Manhattan Bldg., Chicago.

WANTED: Used Rider's Service Manuals. Write Box 87, Ft. Payne, Ala.

PATENT ATTORNEYS

INVENTORS—Before disclosing your invention to any one send for Form "Evidence of Conception"; "Schedule of Government and Attorneys' Fees" and instructions. Sent free. Lancaster, Allwine & Rommel, 414 Bowen Building, Washington, D. C.

PATENTS—Advice and booklet free. Highest references. Best results. Promptness assured. Watson E. Coleman, Patent Lawyer, 724 9th Street, Washington, D. C.

RADIO ENGINEERING

RADIO Engineering, broadcasting, aviation and police radio, servicing, marine and Morse telegraphy taught thoroughly. All expenses low. Catalog free. Dodge's Institute, Elm St., Valparaiso, Ind.

RADIO

WE buy and sell used radio testing equipment. Harold Davis, Inc., Jackson, Miss.

MISCELLANEOUS

SALARIED Positions: \$2,500 yearly and up (none lower). Let us try to get one for you; small cost. Write for valuable information No. R-1. Executive's Promotion Service, Washington, D. C.

AMBITIOUS? Extra money showing talks. Home or neighboring towns—no investments—sound equipment, films rented reasonably—\$100—\$300 monthly possible—wonderful opportunity—No. 512 State Theatre Building, Pittsburgh, Pennsylvania.

FLUORESCENT AC Daylight lighting for desk; office; windows; home. Latest sensation. 50% discount. Literature Free. McGee Radio, F-2073, Kansas City, Mo.



So much
for
SO LITTLE...

- Originally introduced by others as a purely price proposition, the miniature can electrolytic has become the practical and dependable Aerovox Dandee. Adequate dry section; true hermetic sealing; proper safety venting; spun-over jacket ends to eliminate shorts; polarity-indicating end washers; conservative ratings—these features have justified these tiny electrolytics for many uses. In single and double sections. 25 to 450 v. 4 to 100 mfd.

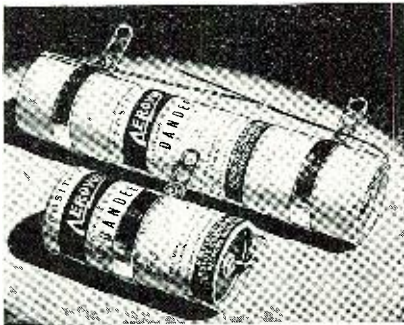

- Dandees are also available in high-capacity low-voltage units. 1000 to 3000 mfd. 6, 12 and 15 v. D.C.W. Units are supplied with mounting straps except for a larger can size unit which has standard mounting ring.

Ask for CATALOG . . .

- See our extensive listings of Dandees in latest catalog. Ask your local jobber for copy—or write us direct.



W4EFD, Montgomery, Ala., has had little trouble with rig but is again active. Thanks Ed for nice words about amateur activity in R.V. We can't quit when we get encouragement like that.

W4KB at Valpariso, and everybody knows Jimmie, invited us to his 1940 hamfest long time in advance. Jimmie is on 75 and 100 fone as is ditto his XL Myrtle. Jimmie as you fellows know has done his operating from Bed being crippled and is a prince of a fellow. Nice going fella.

I see that **FKSAA** of Noumea, New Caledonia, is still on 6.12 meg. Monday and Friday from 11:30 p.m. to 12:30 a.m. despite reports to the contrary. The station announces "Ici Noumea," and signs off with the "Marsellaise."

That unidentified Orientals have been logged on 9.10 meg. near 5:30 a.m., on 6.35 meg. near 6:30 a.m., on 10.05 meg. near 7 a.m., on 5.10 meg. near 4 a.m., and on 7.37 meg. near 6 a.m. **FY3PP** claims he is in Cayenne, French Guiana and says although he is not officially licensed he is in no immediate danger. He told **W6GR** that he was an F8 and already had his FV cards printed and would mail them from France in the Spring. That really sounds encouraging.

CX2AJ has been doing some 40 meter c. w. work lately and has been testing by crossband with **LU2CW** on 20.

XELAM, the old c. w. man is getting on 20 meter phone with cathode modulation. **SU2GK** of Alexandria, Egypt just got his transmitter set up and he really puts a fb sig into the states. He says his home is in England and he hopes to stay down there and give many of the boys a new country. His frequency is (14.400 kc. T9).

From Europe we hear the following stations, all legitimate: **UK3AH**, **U3DS**, **HA7T**, **HA9Q**, **YU7LX**, **LX100**, **PX1A**, **I11R**, and **EA7AV**.

The most popular XU stations on the air are **XU1A** and **XU1B**. Pap and Henry are real ragchewers. They have been logged by many of the W4 boys as late as noon in the day. The **XU6 QSL Manager**, **XU6AW**, is no longer in Canton.

W5CTW wants some dope on **AC4YN**. His exact frequency is not known but he can be found on the low frequency end of the twenty meter band in the early mornings on the week ends.

W1KZN put up a pip of a 10 meter sky wire wid the help of **W1JXQ**, but hasn't got around to building the rig yet.

W1KOP is running almost a kw nw on 20 es gets all fb reports from all parts of the world. Keep up the good work Jack.

W1KNH is very active on 20 cw es 5 meter fone but is nw thinking of putting his rig on 10.

W1LNK is still lying awake nites trying to find a way to put up a decent 20 meter antenna. As **W1IEX** is located next door, the antenna problem is quite complicated. hi!

W1KCS has just put up a new beam antenna for 2 1/2 meters. Al sez it works fb, the only trouble being that he has to rotate the beam by hand.

W7GPM Idaho City, Idaho, **W7FDL**, Rosalia, Wash., **W7GIP**, Boise, Idaho, **W7GWI**, Burke, Idaho, **W7POX**, Orville, Wash., **W7CJO**, Hermiston, Oregon, **W7DTF**, American Falls, Idaho, and **W7EYR**, Caldwell, Idaho, have all been coming in with wonderful signals in Montana.

W7FHC of Luther, Montana is on 1875 kilocycles and trying to work some DX mornings between 4:30 a.m. and daylight, and is especially looking W2's, 4's and W3's.

-30-

Servicemen's Case Histories (Continued from page 40)

GENERAL ELECTRIC F-63
Distortion on .1) resistor R-3 (see schematic strong signals circuit diagram connected to wrong lug on terminal strip insufficient friction in dial-drive assembly. Insert small fibre or cardboard strips between pressure plates

GENERAL ELECTRIC F-75
Noisy when .1) louvre dial not properly receiver is grounded. Check contact of moved or jarred copper ribbons at points where they are spot welded to chassis

GENERAL ELECTRIC F-88
Late-production 1) the 6A8 screen resistor (R-4) has been changed from 2,200 ohms to 4,700 ohms
2) by-pass condenser (C-23) has been disconnected from second i-f screen and connected to screen of first i-f tube
3) second i-f screen has been connected to the converter and first i-f plate-supply lead through a 68,000-ohm dropping resistor (R-4A) which has been by-passed by a 0.05-mfd. 400-volt condenser (C-23A)

4) resistance (R-20) in series with crystal pickup has been reduced from 270,000 ohms to 39,000 ohms. The parallel resistance (R-21) has been reduced from 220,000

ohms to 100,000 ohms. The parallel capacity (C-39) has been increased from 0.0005 mfd. to 0.002 mfd.

GENERAL ELECTRIC F-96
Depressing a .1) check the latch-bar spring. tuning button If there is only one spring, does not release and that spring is in the center of the latch bar, decreasing the tension will remedy the trouble. Another solution is to replace the button which was depressed previously the center spring with two springs, one at each end of the latch bar. They should have approximately the same tension. Make sure that the ears on the latch bar are twisted sufficiently to reduce, to a minimum, all play in the direction of key movement

Trimmers do .1) inspect the trimmer for a bent lug. The lug may be bent in such a manner that the high-frequency range assigned to them separate sufficiently to reach minimum capacity. It will be found that stability is better if care is exercised to operate the trimmers near maximum capacity where possible, rather than using the trimmer of the next higher range and thus operating that trimmer at minimum capacity

GENERAL ELECTRIC F-107
Automatic tun-1) "Touch Tuning" button leads er unit operates not making good contact to adjust stable contact pins. torily—skipping past stations 2) Clean contacts and re-insert sliding contactor blade either covered by thin piece of bakelite or dirty. Carefully run fine file over top of sliding contactor, making sure not to leave any sharp corners. Sliding contactor should have a small amount of variance on beveled surface to prevent chattering

3) nipple too sharp on adjustment contacts will cause sliding contactor blade to jump across. Smooth with fine sand paper

4) relay—mat out of adjustment causing sluggish operation of relay switch. Backstop for relay armature should be adjusted so that a potential of 4.5 volts is sufficient to snap relay closed. The backstop must make positive contact with armature when relay is open. If the relay will not close at 4.5 volts and still maintain proper travel and sequence, weaken the spring holding armature open. After any adjustment on relay, sequence in which contacts open should be checked to open in the order described in paragraph No. 1 under "noise in audio output" (see below)

5) excessive side play in sliding contactor. Loosen the set-screw on the back of the sliding contactor, and slide holder together. Final adjustment should allow sliding contactor to rock freely

6) not enough tension on sliding contactor arm. Loosen collar on shaft in rear of contact segment and move sliding contactor arm towards the contact segment; then tighten collar on shaft

7) if the contacts at the rear of the "Touch Tuning" button assembly shafts do not close or make good contact, the motor will continue to scan the dial without stopping at the desired station. Adjust by bending contacts.

8) contact segment may be bent out of shape. This should be perpendicular to chassis deck and parallel to rear chassis apron in order to allow the adjustable contacts to wiper the contacts evenly

9) contacts at rear of the button shafts touching, or shaft is touching contact. Adjust by bending contacts

No action . . . 1) relay remains energized and audio continues to function —push button escutcheon grounded. Be sure dial and push button escutcheons are insulated from each other or from the control shafts

2) "Off" switch contacts do not close

3) if set does not tune automatically unless scan button is also depressed, contacts No. 6 require closer spacing

4) open or shorted motor capacitor — characterized by motor armature "humming" but no torque. Replace 1,000-mfd. capacitor C58

5) open or shorted coil in motor — characterized by no torque or low torque in one direction. Replace motor or repair coil

6) drive mechanism bound, or too tight for motor to drive not enough friction in Slip Pulley—the friction of the Slip Pulley is adjusted by tightening the collar on the end of the motor shaft. Care should be exercised that the set-screw does not hit the relay armature

7) belt slippage—the tension of the belt may be increased by raising the motor on the

relax bracket. If the belt still slips, reverse belt and use other surface or use belt dressing. (Unsatisfactory operation of the automatic tuner unit on some of the earlier models is caused by a slipping drive belt.

-30-

THE NEW CHANNEL-ANALYZER

Follows the SIGNAL from Antenna to Speaker

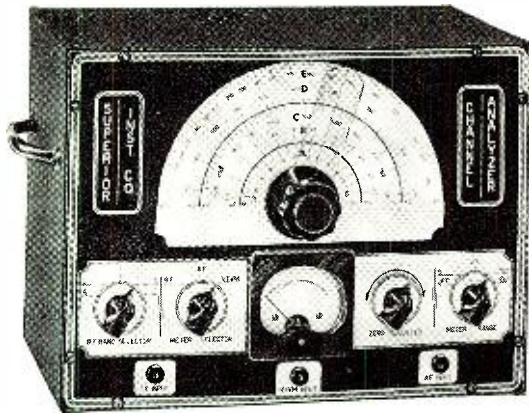

The well-established and authentic SIGNAL TRACING METHOD of locating the very circuit in which there is trouble, and the very component that causes the trouble, is now for the first time available at a price any radio serviceman can afford.

THE CHANNEL-ANALYZER will

- ★ Follow signal from antenna to speaker through all stages of any receiver ever made.
 - ★ Instantly track down exact cause of intermittent operation.
 - ★ Measure both Automatic Volume Control and Automatic Frequency Control, voltages and circuits without appreciably loading the circuit, using built-in highly sensitive Vacuum-Tube Voltmeter.
 - ★ Check exact gain of every individual stage in receiver.
 - ★ Track down and locate cause of distortion in R.F., I.F., and A.F. amplifiers.
 - ★ Check exact operating voltage of each tube.
 - ★ Locate leaky condensers and all high-resistance shorts, also show opens.
 - ★ Measure exact frequencies, amount of drift and comparative output of oscillators in superhets.
 - ★ Track down exact cause of noise.
- The Superior Channel-Analyzer comes housed in shielded cabinet and features an attractive etched aluminum panel. Supplied complete with tubes, three specially engineered shielded input cables, each identified as to its purpose. Also full operating instructions. Size 13"x10"x6". Shipping weight 15 pounds. Only

\$19⁹⁵

THE NEW MODEL 1280 SET-TESTER

Combines Models 1240 and 1250

A complete testing laboratory in one unit, the Model 1280 combines the Models 1250 Multitester and 1240 Tube Tester. (See specifications of each below.)

- ★ Instantaneous Snap Switches Reduce Actual Testing Time to Absolute Minimum.
- ★ Spare Socket and Filament Voltages Up to 120 Volts. Make the Model 1280 Obsolescence Proof.
- ★ Latest Design 4 1/2" D'Arsonval Type Meter.
- ★ Works on 90 to 125 Volts 60 Cycles A.C.



Even those servicemen who through past purchases know they can always get SUPER-VALUES from Superior, will be amazed and delighted when they read the specifications of this all-purpose instrument and then note the unbelievably low price. The Model 1280 features a 4 1/2" D'Arsonval type meter for easy reading of the various scales, and in line with our new policy of stressing appearance as well as serviceability in our new 1200 line of test equipment, our Model 1280 utilizes an aluminum etched panel, designed for beauty as well as ruggedness. The primary function of an instrument is, of course, to make measurements accurately and when designing test equipment this is our first thought. However, we also appreciate the important part the appearance of an instrument plays in the impression a serviceman makes on his customers, especially on home calls. We have, therefore, paid special attention to the outward design of all of our new instruments. For instance, the panel of this Model 1280 is made of heavy-gauge aluminum and etched by a radically new process which results in a beautiful, confidence-inspiring appearance.

Model 1280 comes complete with test leads, tabular data and instructions. Shipping weight 18 pounds. Size 13"x11"x6 1/2". Our net price

\$19⁷⁵

Portable cover \$1.00 additional

THE NEW MODEL 1250 MULTITESTER

SLOPING PANEL FOR PRECISE RAPID SERVICING



Etched Aluminum Panel

Specially Designed Electronic Rectifier Enables Linear A.C. Scale, High Stability and Little or no Temperature Drift.

Here is an opportunity to acquire a Multi-Service, Precision Engineered Instrument, for less than you would have to pay for an ordinary Volt-Ohm Milliammeter. Besides making the usual volt, resistance and current measurements (both A.C. and D.C.) this unit accurately measures the CAPACITIES of mica, paper and electrolytic condensers, INDUCTION of coils, chokes and transformers. DECIBEL gain or loss, of power amplifiers and public address systems, WATTS output of amplifiers, receivers, etc.

SPECIFICATIONS

| | |
|---|--|
| Complete A.C. and D.C. Voltage and Current Ranges | High and Low Capacity Scales |
| D.C. Voltage: — 0-15, 0-150, 0-750 volts | .0005 to 1 mfd. and .05 to 50 mfd. |
| A.C. Voltage: — 0-15, 0-150, 0-750 volts | 3 Decibel Ranges |
| D.C. Current: — 0.1, 0-15, 0-150, 0-750 ma. | —10 to +19, —10 to +38, —10 to +53 |
| A.C. Current: —0-15, 0-150, 0-750 ma. | Inductance: 1 to 700 Henries |
| 2 Resistance Ranges | Watts: Based on 6 mw. at 0 D.B. in 500 ohms .006000 to 600 Watts |
| 0-50 ohms, 500-5 megohms | |

Model 1250 works on 90-120 volts 60 cycles A.C. Comes complete with test leads, tabular charts and instructions. Shipping weight 9 lbs. Size 9 1/2"x11"x6 1/2". Our net price

\$11⁸⁵

Portable Cover \$1.00 Additional

THE NEW MODEL 1240 TUBE TESTER

Instantaneous Snap Switches Reduce Actual Testing Time to Absolute Minimum

Tests All Tubes 1.4 to 117 Volts

Sockets for All Tubes—No Adapters

Superior is proud to offer the newest and most practical tube tester ever designed. Unbelievably low in price—unbelievably high in performance.

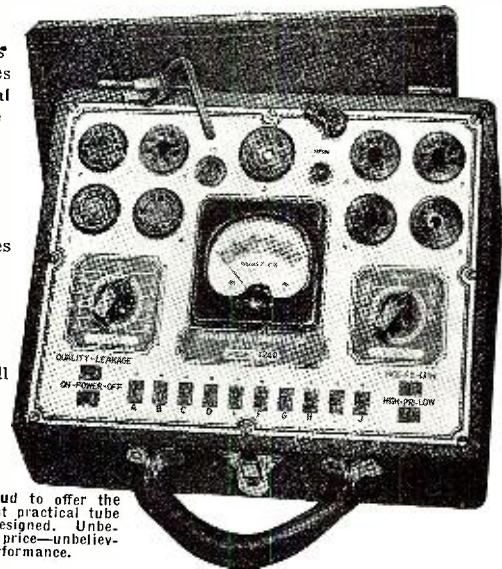

- ★ Tests all tubes, 1.4 to 117 Volts, including 4, 5, 6, 7, 7L, octals, loctals, Bantam Jr., Peanut, single ended, floating filament, Mercury Vapor Rectifiers, the new S series, in fact, every tube designed to date.
 - ★ Spare socket included on front panel for any future tubes.
 - ★ Tests by the well-established emission method for tube quality directly read on the GOOD ? BAD scale of the meter.
 - ★ Jewel protected neon.
 - ★ Tests shorts and leakages up to 2 megohms in all tubes.
 - ★ Tests leakages and shorts in all elements AGAINST all elements in all tubes.
 - ★ Tests BOTH plates in rectifiers.
 - ★ Tests individual sections such as diodes, triodes, pentodes, etc., in multi-purpose tubes.
 - ★ Latest type voltage regulator.
 - ★ Features an attractive etched aluminum panel.
 - ★ Works on 90 to 125 volts 60 cycles A.C.
- Model 1240 comes complete with instructions and tabular data for every known type of receiving tube. Shipping weight 12 pounds. Size 6"x7 1/2"x10 3/4". Our Net Price

\$11⁸⁵

Portable Cover \$1.00 Additional

SUPERIOR INSTRUMENTS CO.

136 LIBERTY ST., DEPT. RN8
NEW YORK, N. Y.

Announcing

THE HANDIEST BOOK OF ALL!

RCA HAM GUIDE...

Hot Off the Press



Here's the Guide you've been waiting for—the most genuinely helpful, complete and practical volume of its kind RCA has ever issued. Written specifically for the amateur, it contains 48 pages filled with timely technical information on transmitter construction, transmitting tube circuits and complete data on amateur radio's finest line of tubes.

Easy-to-build rigs designed from "mike to tank"; latest in cathode modulation; "hot" plate-modulated and c-w rigs; straight-forward single-stage circuits, up-to-the-minute data on famous tubes such as the RCA-802, 806, 807, 808, 809, 810, 811, 812, 828 and many others. Tells what to do and exactly how to do it. Richly illustrated, it is a boon to the newcomer, indispensable to the old-timer—a book that is a "must item" for every shack.

Available through RCA Power Tube Distributors, or send 15c direct to RCA Commercial Engineering Section, Harrison, N. J.

HAM TIPS *Free*

This helpful little publication is prepared by RCA specifically for the amateur. Free from all RCA Power Tube Distributors.



● 48 Pages Chock Full of Timely Circuits, Photographs, Construction Features and Data on Amateur Radio's Finest Transmitting Tubes. 15c Amateur Net.



Transmitting Tubes

For PERFORMANCE PLUS

RCA MANUFACTURING COMPANY, INC., CAMDEN, N. J. • A Service of the Radio Corporation of America